

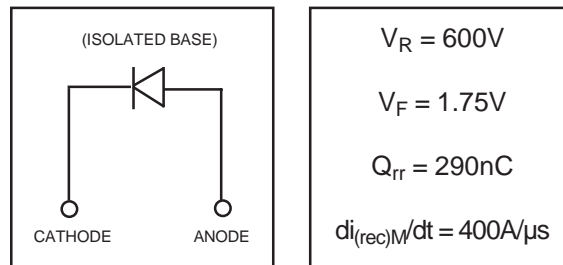
# HFA40HF60

HEXFRED™

Ultrafast, Soft Recovery Diode

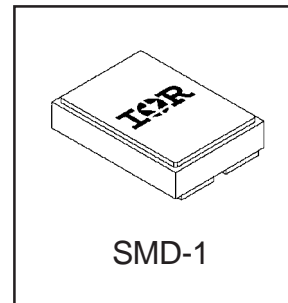
## Features

- Reduced RFI and EMI
- Reduced Snubbing
- Extensive Characterization of Recovery Parameters
- Hermetic
- Surface Mount



## Description

HEXFRED™ diodes are optimized to reduce losses and EMI/RFI in high frequency power conditioning systems. An extensive characterization of the recovery behavior for different values of current, temperature and di/dt simplifies the calculations of losses in the operating conditions. The softness of the recovery eliminates the need for a snubber in most applications. These devices are ideally suited for power converters, motors drives and other applications where switching losses are significant portion of the total losses.



## Absolute Maximum Ratings (per Leg)

	Parameter	Max.	Units
$V_R$	D.C. Reverse Voltage	600	V
$I_F @ T_C = 100^\circ C$	Continuous Forward Current ①	22	A
$I_{FSM} @ T_C = 25^\circ C$	Single Pulse Forward Current ②	225	
$P_D @ T_C = 25^\circ C$	Maximum Power Dissipation	83	W
$T_J$	Operating Junction and	-55 to +150	$^\circ C$
$T_{STG}$	Storage Temperature Range		

## Thermal - Mechanical Characteristics

	Parameter	Typ.	Max.	Units
$R_{\theta JC}$	Junction-to-Case, Single Leg Conducting	—	1.5	$^\circ C/W$
	Weight	2.4	—	g

**Note:** ① D.C. = 50% rect. wave

② 1/2 sine wave, 60 Hz, P.W. = 8.33 ms

www.irf.com

# HFA40HF60

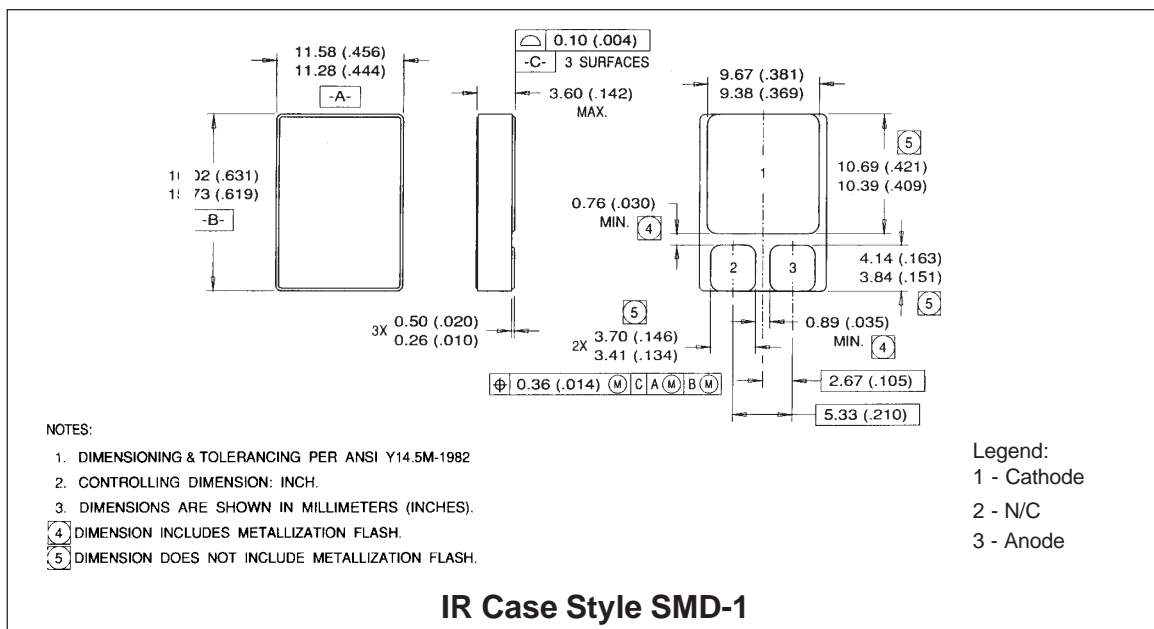
International  
IR Rectifier

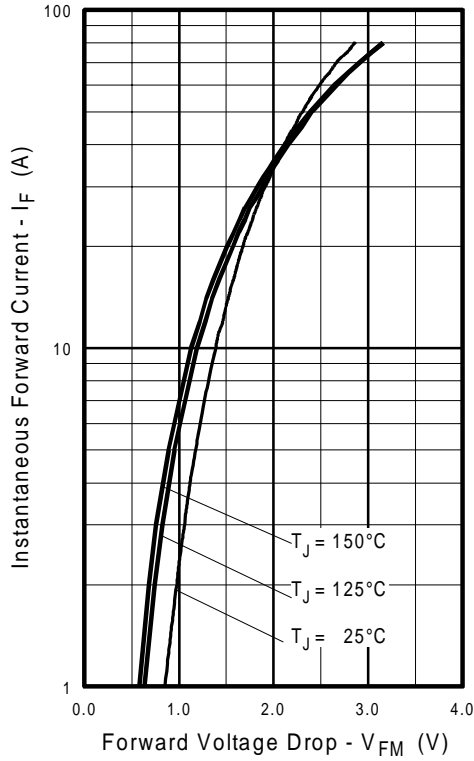
## Electrical Characteristics (per Leg) @ $T_J = 25^\circ\text{C}$ (unless otherwise specified)

	Parameter	Min.	Typ.	Max.	Units	Test Conditions
$V_{BR}$	Cathode Anode Breakdown Voltage	600	—	—	V	$I_R = 100\mu\text{A}$
$V_{FM}$	Max Forward Voltage	—	1.63	1.75	V	$I_F = 22\text{A}$
		—	2.07	2.25		$I_F = 45\text{A}$ See Fig. 1
		—	1.52	1.64		$I_F = 22\text{A}, T_J = 125^\circ\text{C}$
$I_{RM}$	Max Reverse Leakage Current	—	—	10	$\mu\text{A}$	$V_R = V_R$ Rated See Fig. 2
		—	—	1.0	$\text{mA}$	$T_J = 125^\circ\text{C}, V_R = 480\text{V}$
$C_T$	Junction Capacitance	—	56	59	$\text{pF}$	$V_R = 200\text{V}$ See Fig. 3
$L_S$	Series Inductance	—	2.8	—	$\text{nH}$	Measured from center of bond pad to end of anode bonding wire

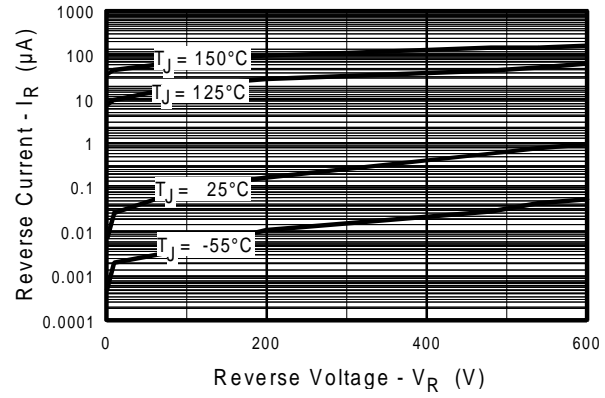
## Dynamic Recovery Characteristics (per Leg) @ $T_J = 25^\circ\text{C}$ (unless otherwise specified)

	Parameter	Min.	Typ.	Max.	Units	Test Conditions
$t_{rr1}$	Reverse Recovery Time	—	60	90	ns	$T_J = 25^\circ\text{C}$ See Fig.
$t_{rr2}$		—	110	165		$T_J = 125^\circ\text{C}$ 5
$I_{RRM1}$	Peak Recovery Current	—	5.2	7.8	A	$T_J = 25^\circ\text{C}$ See Fig.
$I_{RRM2}$		—	8.5	13		$T_J = 125^\circ\text{C}$ 6
$Q_{rr1}$	Reverse Recovery Charge	—	190	290	nC	$T_J = 25^\circ\text{C}$ See Fig.
$Q_{rr2}$		—	560	840		$T_J = 125^\circ\text{C}$ 7
$di_{(rec)M}/dt1$	Peak Rate of Fall of Recovery Current During $t_b$	—	270	400	$\text{A}/\mu\text{s}$	$T_J = 25^\circ\text{C}$ See Fig.
$di_{(rec)M}/dt2$		—	170	250		$T_J = 125^\circ\text{C}$ 8

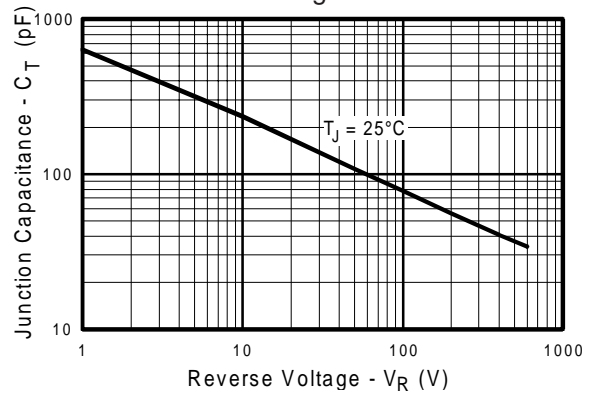




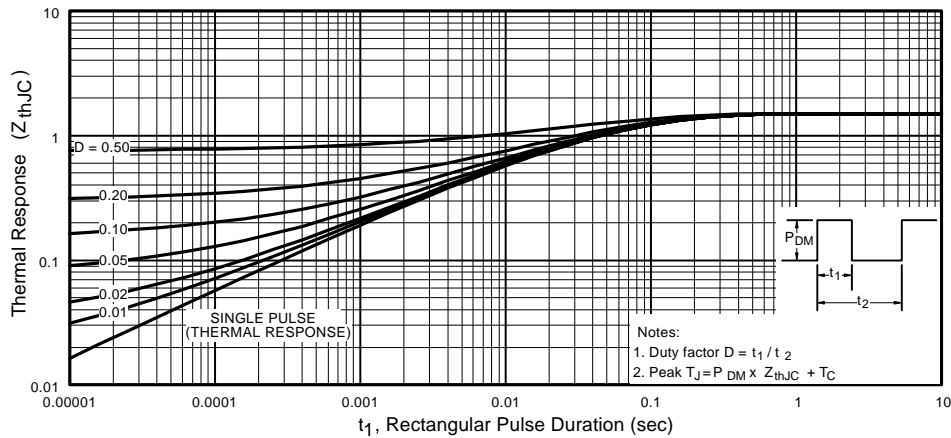
**Fig. 1** - Maximum Forward Voltage Drop vs. Instantaneous Forward Current



**Fig. 2** - Typical Reverse Current vs. Reverse Voltage



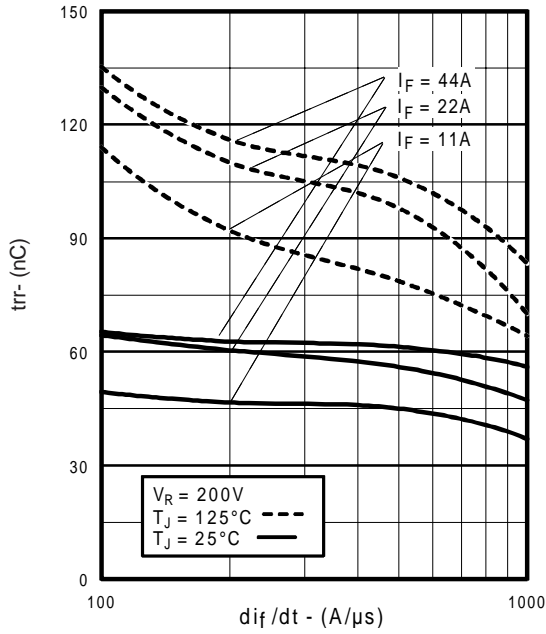
**Fig. 3** - Typical Junction Capacitance vs. Reverse Voltage



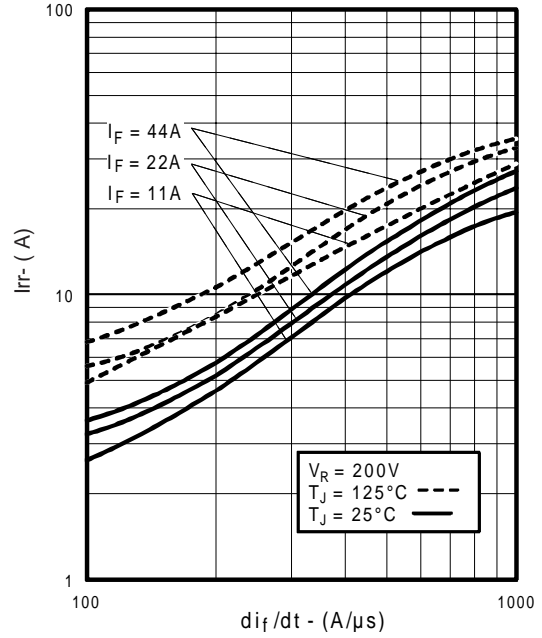
**Fig. 4** - Maximum Thermal Impedance  $Z_{thJC}$  Characteristics

# HFA40HF60

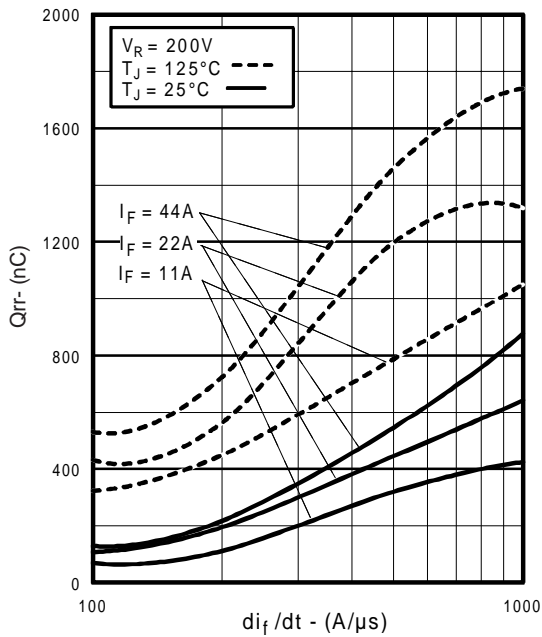
International  
**IR** Rectifier



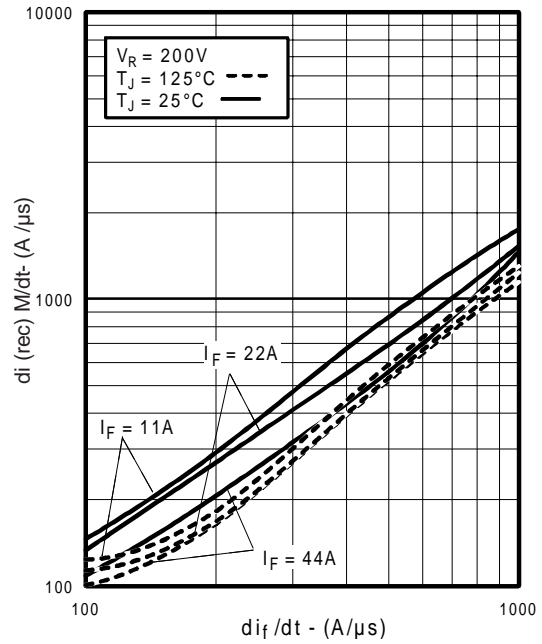
**Fig. 5** - Typical Reverse Recovery vs.  $di_f/dt$



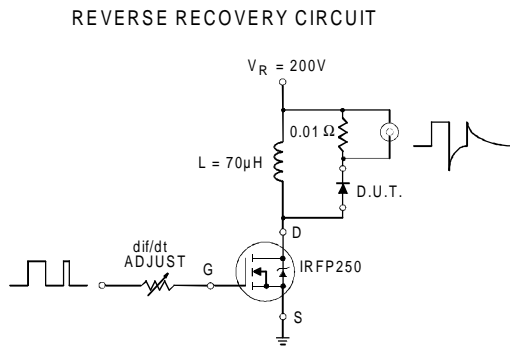
**Fig. 6** - Typical Recovery Current vs.  $di_f/dt$



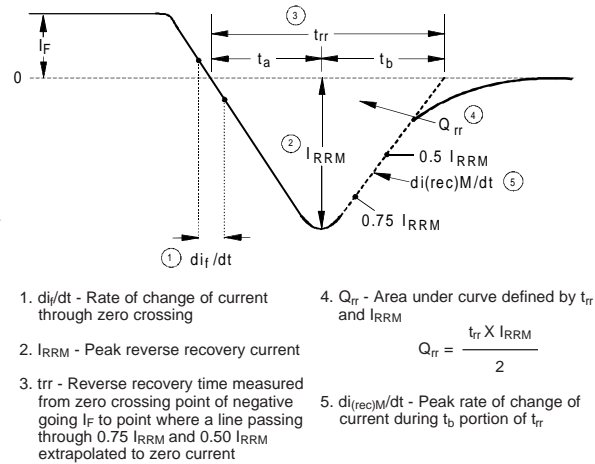
**Fig. 7** - Typical Stored Charge vs.  $di_f/dt$



**Fig. 8** - Typical  $di_{(rec)}M/dt$  vs.  $di_f/dt$



**Fig. 9** - Reverse Recovery Parameter Test Circuit



**Fig. 10** - Reverse Recovery Waveform and Definitions