

$V_R = 600V$
$V_F(\text{typ.})^* = 1.4V$
$I_{F(AV)} = 60A$
$Q_{rr}(\text{typ.}) = 270nC$
$I_{RRM}(\text{typ.}) = 7.0A$
$t_{rr}(\text{typ.}) = 65ns$
$di_{(rec)M}/dt(\text{typ.})^* = 270A/\mu s$

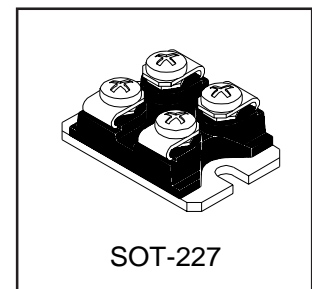
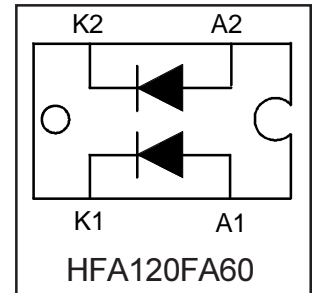

Features

- Fast Recovery time characteristic
- Electrically isolated base plate
- Large creepage distance between terminal
- Simplified mechanical designs, rapid assembly

Description

This SOT-227 module with FRED rectifier is available into parallel configuration, used for simple parallel rectifier and high current application. The semiconductor in the SOT-227 package is isolated from the copper base plate, allowing for common heatsinks and compact assemblies to be built.

That module is intended for general applications such as power supplies, battery chargers, electronic welders, motor control, DC chopper, and inverters.

Absolute Maximum Ratings (per Leg)

	Parameter	Max.	Units
V_R	Cathode-to-Anode Voltage	600	V
$I_F @ T_C = 25^\circ C$	Continuous Forward Current	75	A
$I_F @ T_C = 100^\circ C$	Continuous Forward Current	40	
I_{FSM}	Single Pulse Forward Current	TBD	
I_{FRM}	Maximum Repetitive Forward Current	180	
V_{ISOL}	RMS Isolation Voltage, Any Terminal to Case, t=1 min	2500	V
$P_D @ T_C = 25^\circ C$	Maximum Power Dissipation	180	W
$P_D @ T_C = 100^\circ C$	Maximum Power Dissipation	71	
T_J	Operating Junction and	-55 to +150	$^\circ C$
T_{STG}	Storage Temperature Range		

*125 $^\circ C$

Electrical Characteristics (per Leg) @ T_J = 25°C (unless otherwise specified)

	Parameter	Min.	Typ.	Max.	Units	Test Conditions
V _{BR}	Cathode Anode Breakdown Voltage	600	—	—	V	I _R = 100μA
V _{FM}	Max Forward Voltage	—	1.5	1.7	V	I _F = 60A
		—	1.9	2.1		I _F = 120A See Fig. 1
		—	1.4	1.6		I _F = 60A, T _J = 125°C
I _{RM}	Max Reverse Leakage Current	—	2.5	20	μA	V _R = V _R Rated See Fig. 2
		—	130	2000		T _J = 125°C, V _R = 0.8 x V _R Rated
C _T	Junction Capacitance	—	120	170	pF	V _R = 200V See Fig. 3

Dynamic Recovery Characteristics (per Leg) @ T_J = 25°C (unless otherwise specified)

	Parameter	Min.	Typ.	Max.	Units	Test Conditions
t _{rr}	Reverse Recovery Time	—	34	—	ns	I _F = 1.0A, di _F /dt = 200A/μs, V _R = 30V
t _{rr1}	See Fig. 5, 6 & 16	—	65	98		T _J = 25°C
t _{rr2}		—	130	200		T _J = 125°C
I _{RRM1}	Peak Recovery Current	—	7.0	13	A	T _J = 25°C
I _{RRM2}	See Fig. 7 & 8	—	13	23		T _J = 125°C
Q _{rr1}	Reverse Recovery Charge	—	270	410	nC	T _J = 25°C
Q _{rr2}	See Fig. 9 & 10	—	490	740		T _J = 125°C
di _{(rec)M} /dt1	Peak Rate of Fall of Recovery Current	—	350	—	A/μs	T _J = 25°C
di _{(rec)M} /dt2	During t _b See Fig. 11 & 12	—	270	—		T _J = 125°C

Thermal - Mechanical Characteristics

	Parameter	Min.	Typ.	Max.	Units
R _{θJC}	Junction-to-Case, Single Leg Conducting	—	—	0.70	°C/W K/W
	Junction-to-Case, Both Legs Conducting	—	—	0.35	
R _{θCS}	Case-to-Sink, Flat , Greased Surface	—	0.05	—	
Wt	Weight	—	30	—	g
	Mounting Torque	—	1.3	—	(N•m)

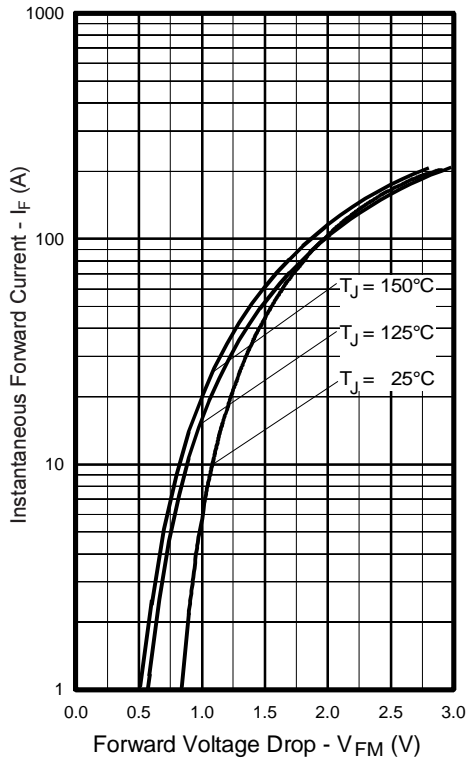

Fig. 1 - Maximum Forward Voltage Drop vs. Instantaneous Forward Current, (per Leg)

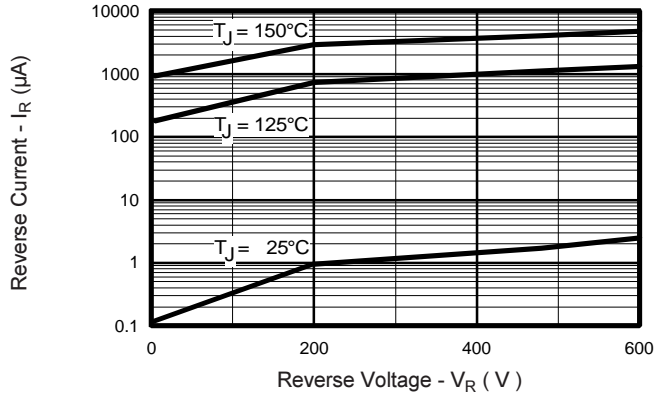

Fig. 2 - Typical Reverse Current vs. Reverse Voltage, (per Leg)

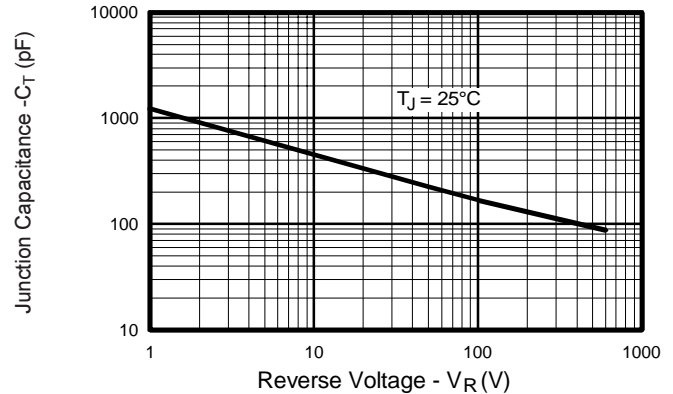

Fig. 3 - Typical Junction Capacitance vs. Reverse Voltage, (per Leg)

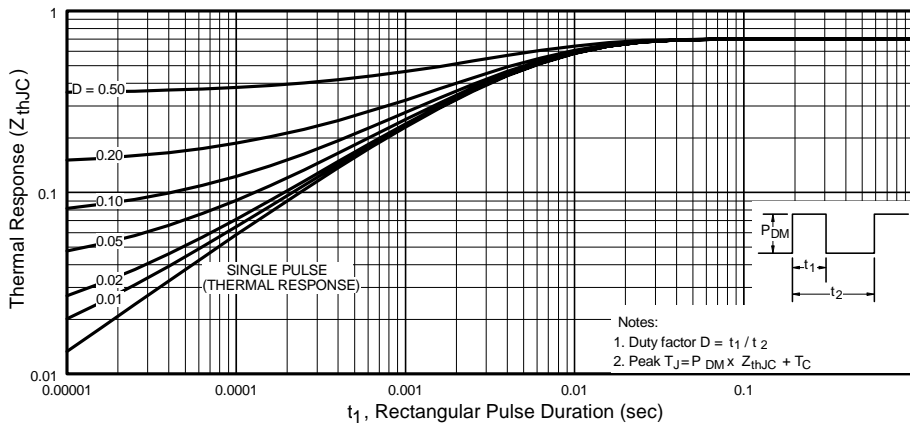

Fig. 4 - Maximum Thermal Impedance Z_{thJC} Characteristics, (per Leg)

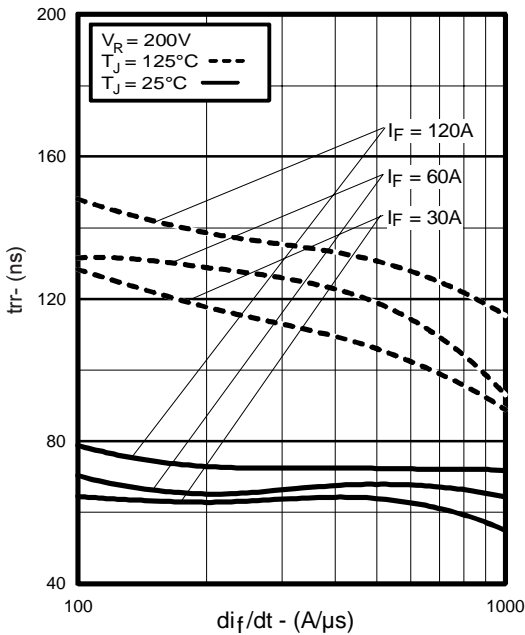

Fig. 5 - Typical Reverse Recovery vs. di_f/dt , (per Leg)

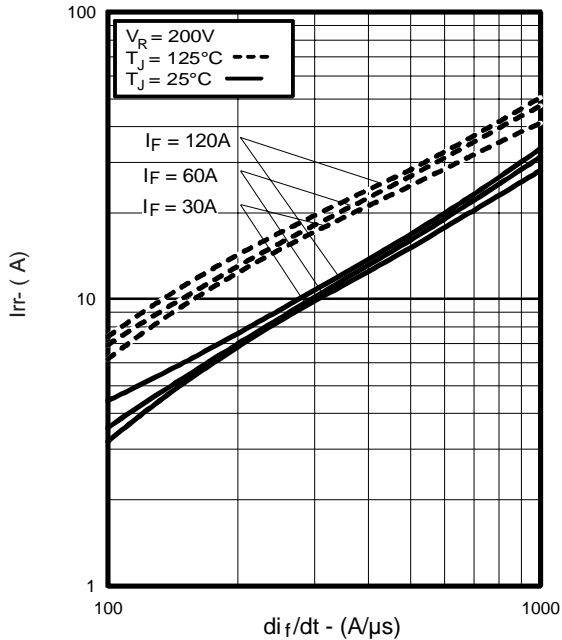

Fig. 6 - Typical Recovery Current vs. di_f/dt , (per Leg)

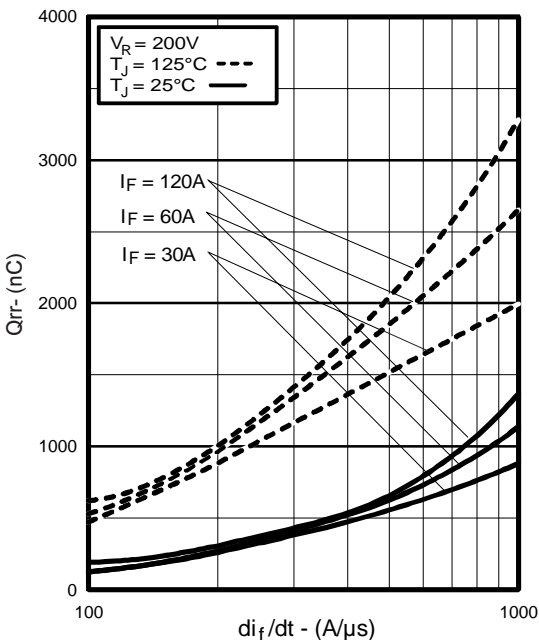

Fig. 7 - Typical Stored Charge vs. di_f/dt , (per Leg)

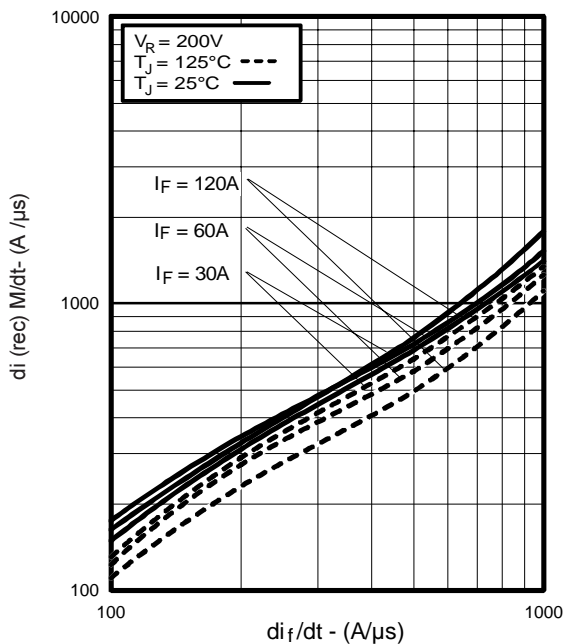

Fig. 8 - Typical $di_{(rec)}M/dt$ vs. di_f/dt , (per Leg)

REVERSE RECOVERY CIRCUIT

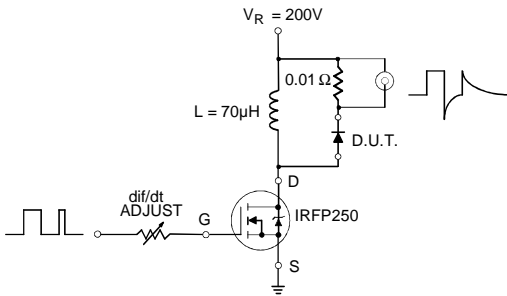
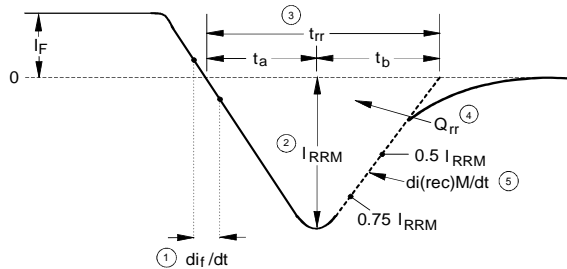

Fig. 9 - Reverse Recovery Parameter Test Circuit



1. di_f/dt - Rate of change of current through zero crossing
2. I_{RRM} - Peak reverse recovery current
3. t_{rr} - Reverse recovery time measured from zero crossing point of negative going I_F to point where a line passing through $0.75 I_{RRM}$ and $0.50 I_{RRM}$ extrapolated to zero current
4. Q_{rr} - Area under curve defined by t_{rr} and I_{RRM}
5. $di_{(rec)M}/dt$ - Peak rate of change of current during t_b portion of t_{rr}

$$Q_{rr} = \frac{t_{rr} \times I_{RRM}}{2}$$

Fig. 10 - Reverse Recovery Waveform and Definitions

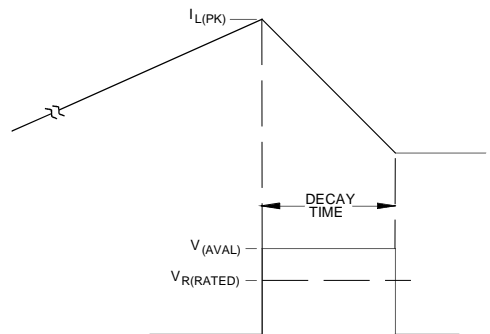
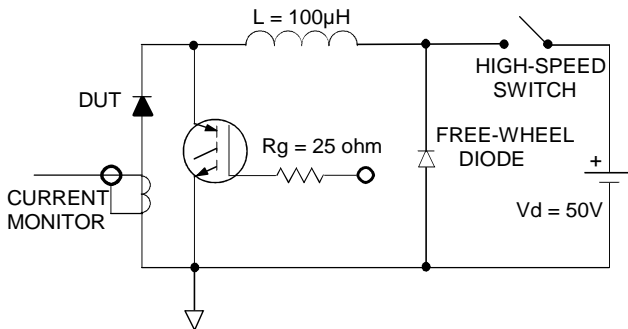

Fig. 11 - Avalanche Test Circuit and Waveforms

HFA120FA60

Bulletin PD-2.531 Rev.A 09/03

International
IR Rectifier

SOT-227 Package Details

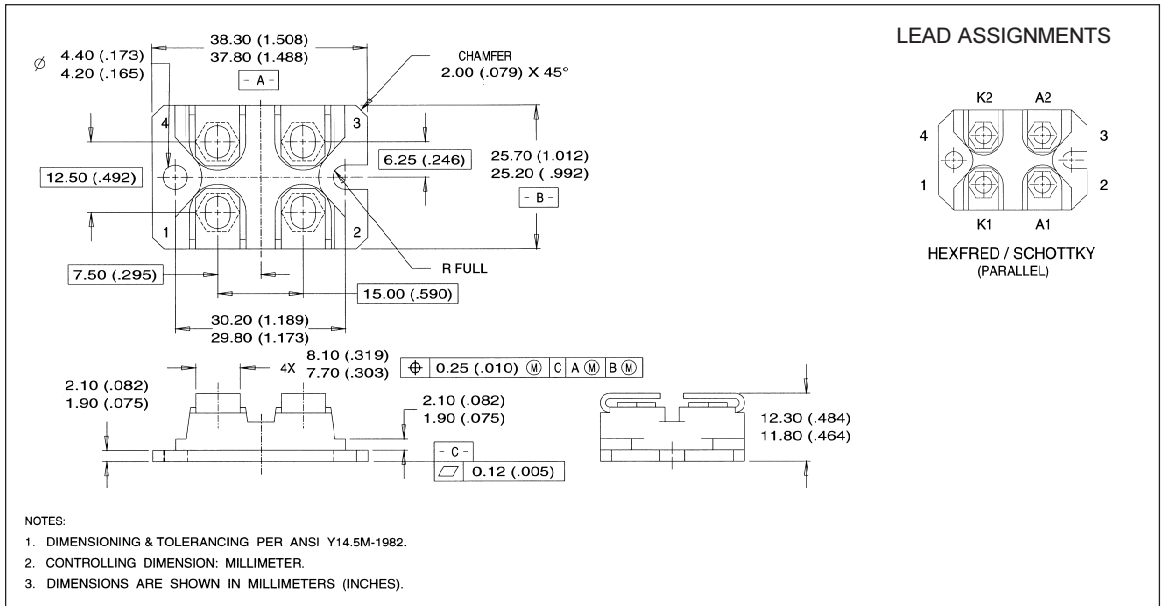

Tube

QUANTITIES PER TUBE IS 10
M4 SREW AND WASHER INCLUDED

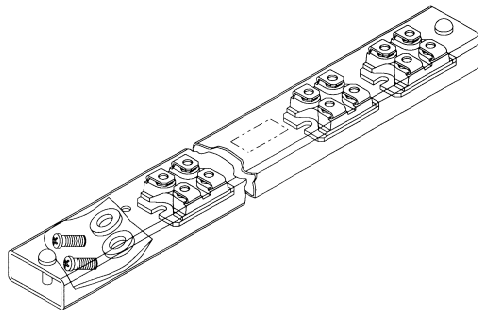

Data and specifications subject to change without notice.
This product has been designed and qualified for Industrial market.
Qualification Standards can be found on IR's Web site.

International
IR Rectifier

IR WORLD HEADQUARTERS: 233 Kansas St., El Segundo, California 90245, USA Tel: (310) 252-7105
TAC Fax: (310) 252-7903

Visit us at www.irf.com for sales contact information. 10/02