

### FEATURES

- n - Channel
- High Switching Speed
- Low Forward Voltage Drop
- Isolated Base

### APPLICATIONS

- PWM Motor Control
- UPS

The Powerline range of modules includes half bridge, chopper, dual and single switch configurations covering voltages from 600V to 3300V and currents up to 2400A.

The GP500LSS06S is a single switch 600V n channel enhancement mode insulated gate bipolar transistor (IGBT) module. The module is suitable for a variety of medium voltage applications in motor drives and power conversion.

The IGBT has a wide reverse bias safe operating area (RBSOA) for ultimate reliability in demanding applications.

These modules incorporate electrically isolated base plates and low inductance construction enabling circuit designers to optimise circuit layouts and utilise earthed heat sinks for safety.

Typical applications include dc motor drives, ac pwm drives and ups systems.

### ORDERING INFORMATION

Order as:

**GP500LSS06S**

Note: When ordering, use complete part number.

### KEY PARAMETERS

$V_{CES}$	<b>600V</b>
$V_{CE(sat)}$	<b>(typ) 2.2V</b>
$I_{C25}$	<b>(max) 700A</b>
$I_{C75}$	<b>(max) 500A</b>
$I_{C(PK)}$	<b>(max) 1400A</b>

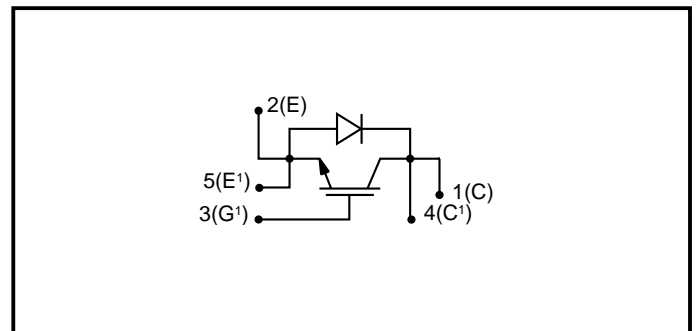

**Fig. 1 Single switch circuit diagram**

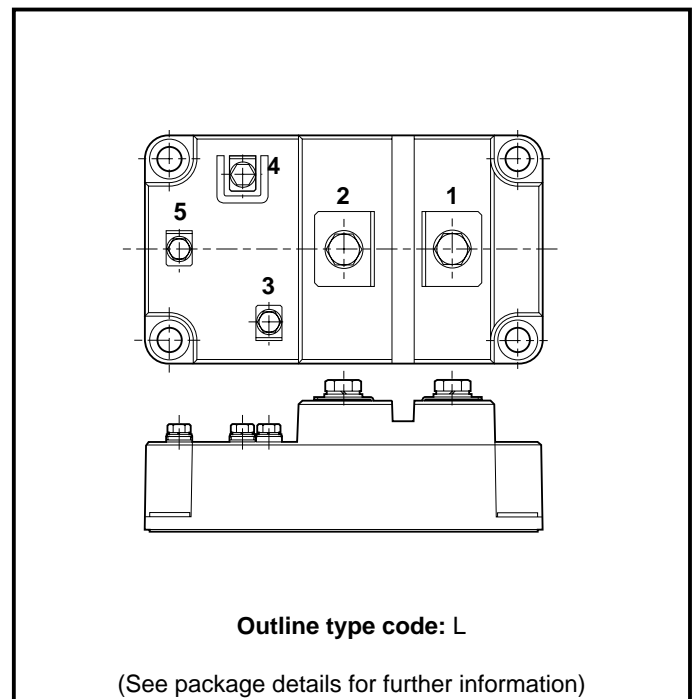

**Fig. 2 Electrical connections - (not to scale)**

## ABSOLUTE MAXIMUM RATINGS

Stresses above those listed under 'Absolute Maximum Ratings' may cause permanent damage to the device. In extreme conditions, as with all semiconductors, this may include potentially hazardous rupture of the package. Appropriate safety precautions should always be followed. Exposure to Absolute Maximum Ratings may affect device reliability.

$T_{case} = 25^{\circ}\text{C}$  unless stated otherwise

Symbol	Parameter	Test Conditions	Max.	Units
$V_{CES}$	Collector-emitter voltage	$V_{GE} = 0V$	600	V
$V_{GES}$	Gate-emitter voltage	-	$\pm 20$	V
$I_C$	Collector current	DC, $T_{case} = 25^{\circ}\text{C}$	700	A
		DC, $T_{case} = 75^{\circ}\text{C}$	500	A
$I_{C(PK)}$		1ms, $T_{case} = 25^{\circ}\text{C}$	1400	A
		1ms, $T_{case} = 75^{\circ}\text{C}$	1000	A
$P_{max}$	Maximum power dissipation	(Transistor)	2500	W
$V_{isol}$	Isolation voltage	Commoned terminals to base plate. AC RMS, 1 min, 50Hz	2500	V

## THERMAL AND MECHANICAL RATINGS

Symbol	Parameter	Conditions	Min.	Max.	Units
$R_{th(j-c)}$	Thermal resistance - transistor	DC junction to case	-	50	$^{\circ}\text{C}/\text{kW}$
$R_{th(j-d)}$	Thermal resistance - diode	DC junction to case	-	125	$^{\circ}\text{C}/\text{kW}$
$R_{th(c-h)}$	Thermal resistance - Case to heatsink	Mounting torque 5Nm (with mounting grease)	-	15	$^{\circ}\text{C}/\text{kW}$
$T_j$	Junction temperature	Transistor	-	150	$^{\circ}\text{C}$
		Diode	-	125	$^{\circ}\text{C}$
$T_{stg}$	Storage temperature range	-	- 40	125	$^{\circ}\text{C}$
-	Screw torque	Mounting - M6	-	5	Nm
		Electrical connections - M4	-	2	Nm
		Electrical connections - M6	-	5	Nm

**ELECTRICAL CHARACTERISTICS**
 $T_j = 25^\circ\text{C}$  unless stated otherwise.

Symbol	Parameter	Conditions	Min.	Typ.	Max.	Units
$I_{CES}$	Collector cut-off current	$V_{GE} = 0V, V_{CE} = V_{CES}$	-	-	25	mA
		$V_{GE} = 0V, V_{CE} = V_{CES}, T_j = 125^\circ\text{C}$	-	-	100	mA
$I_{GES}$	Gate leakage current	$V_{GE} = \pm 20V, V_{CE} = 0V$	-	-	2	$\mu\text{A}$
$V_{GE(TH)}$	Gate threshold voltage	$I_C = \text{mA}, V_{GE} = V_{CE}$	4	-	7.5	V
$V_{CE(SAT)}$	Collector-emitter saturation voltage	$V_{GE} = 15V, I_C = 500A$	-	2.2	2.8	V
		$V_{GE} = 15V, I_C = 500A, T_j = 125^\circ\text{C}$	-	2.3	2.9	V
$I_F$	Diode forward current	DC	-	-	500	A
$I_{FM}$	Diode maximum forward current	$t_p = 1\text{ms}$	-	-	1000	A
$V_F$	Diode forward voltage	$I_F = 500A,$	-	1.1	1.9	V
		$I_F = 500A, T_j = 125^\circ\text{C}$	-	1.05	1.8	V
$C_{ies}$	Input capacitance	$V_{CE} = 25V, V_{GE} = 0V, f = 1\text{MHz}$	-	54000	-	pF
$L_M$	Module inductance	-	-	15	-	nH

**INDUCTIVE SWITCHING CHARACTERISTICS**

$T_j = 25^\circ\text{C}$  unless stated otherwise

Symbol	Parameter	Conditions	Min.	Typ.	Max.	Units
$t_{d(off)}$	Turn-off delay time	$I_C = 500\text{A}$ $V_{GE} = \pm 15\text{V}$ $V_{CE} = 50\% V_{CES}$ $R_{G(ON)} = R_{G(OFF)} = 5\Omega$ $L \sim 100\text{nH}$	-	1150	-	$\mu\text{s}$
$t_f$	Fall time		-	220	-	ns
$E_{OFF}$	Turn-off energy loss		-	45	-	mJ
$t_{d(on)}$	Turn-on delay time		-	490	-	ns
$t_r$	Rise time		-	225	-	ns
$E_{ON}$	Turn-on energy loss		-	30	-	mJ
$t_{rr}$	Diode reverse recovery time	$I_F = 500\text{A}$	-	225	-	ns
$Q_{rr}$	Diode reverse recovery charge	$V_R = 50\%V_{CES}, di_F/dt = 1500\text{A}/\mu\text{s}$	-	20	-	$\mu\text{C}$

$T_j = 125^\circ\text{C}$  unless stated otherwise.

$t_{d(off)}$	Turn-off delay time	$I_C = 500\text{A}$ $V_{GE} = \pm 15\text{V}$ $V_{CE} = 50\% V_{CES}$ $R_{G(ON)} = R_{G(OFF)} = 5\Omega$ $L \sim 100\text{nH}$	-	1400	-	$\mu\text{s}$
$t_f$	Fall time		-	400	-	ns
$E_{OFF}$	Turn-off energy loss		-	65	-	mJ
$t_{d(on)}$	Turn-on delay time		-	550	-	ns
$t_r$	Rise time		-	320	-	ns
$E_{ON}$	Turn-on energy loss		-	50	-	mJ
$t_{rr}$	Diode reverse recovery time	$I_F = 500\text{A}$	-	310	-	ns
$Q_{rr}$	Diode reverse recovery charge	$V_R = 50\%V_{CES}, di_F/dt = 1500\text{A}/\mu\text{s}$	-	28	-	$\mu\text{C}$

**TYPICAL CHARACTERISTICS**

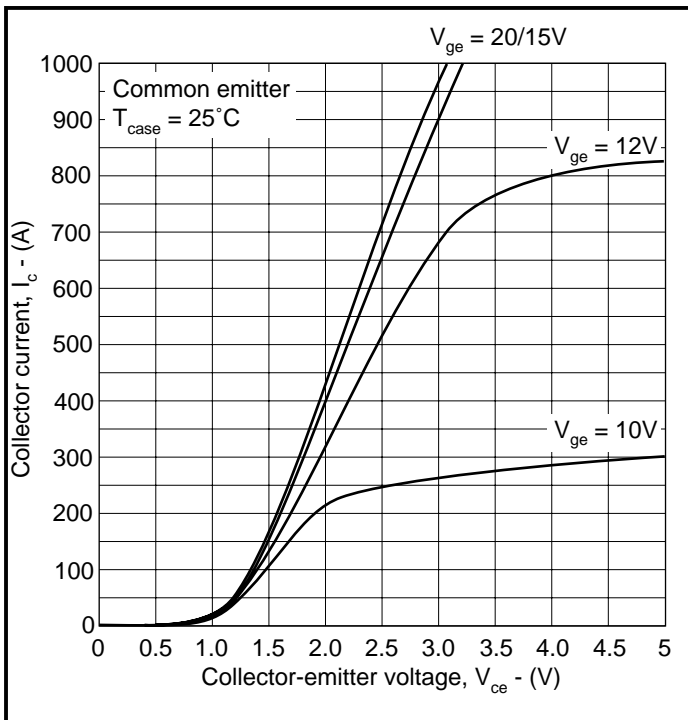

**Fig.3 Typical output characteristics**

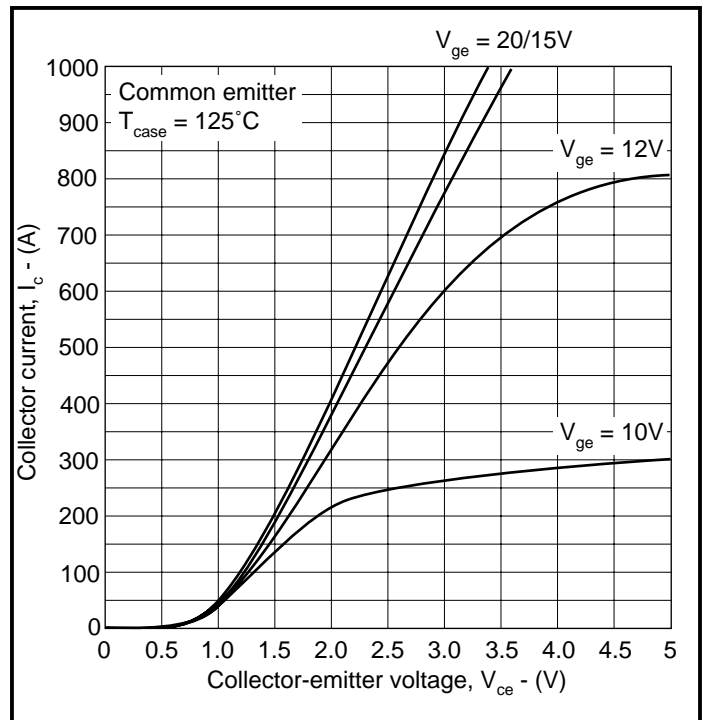

**Fig.4 Typical output characteristics**

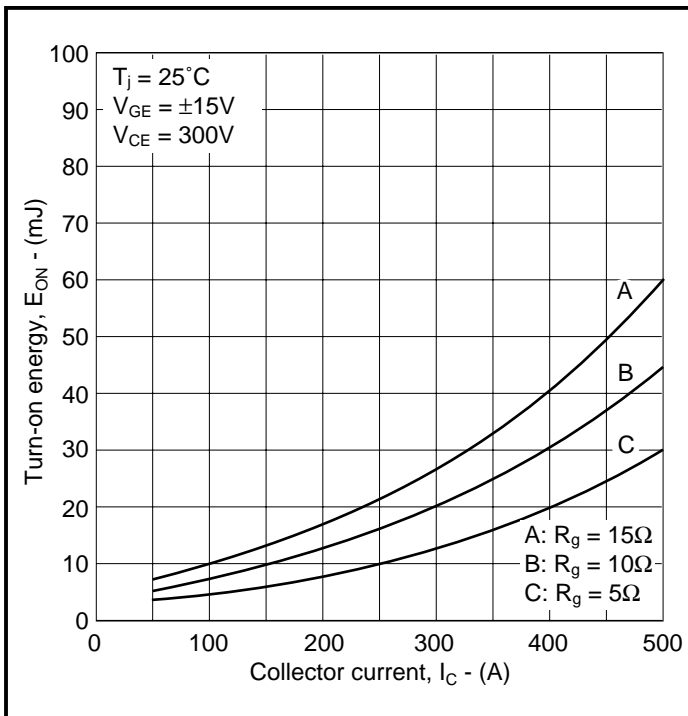

**Fig.5 Typical turn-on energy vs collector current**

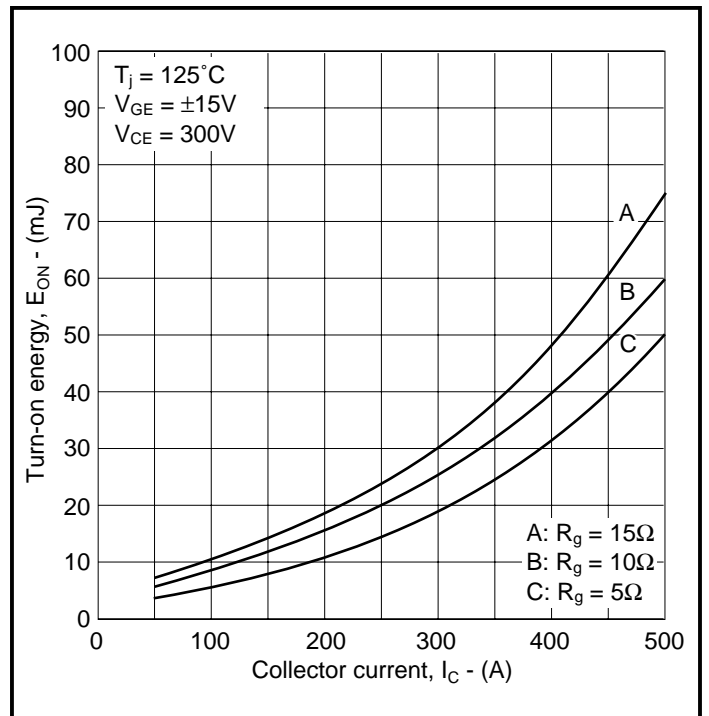

**Fig.6 Typical turn-on energy vs collector current**

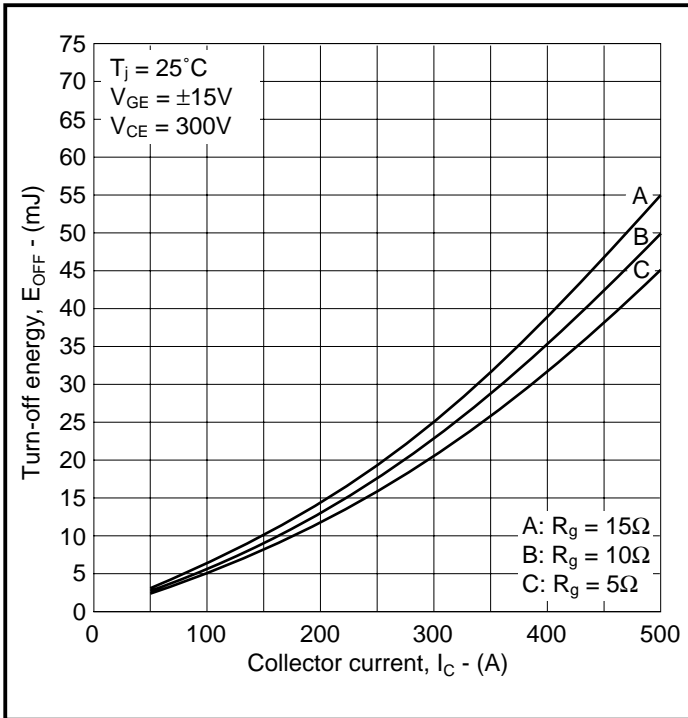

Fig.7 Typical turn-off energy vs collector current

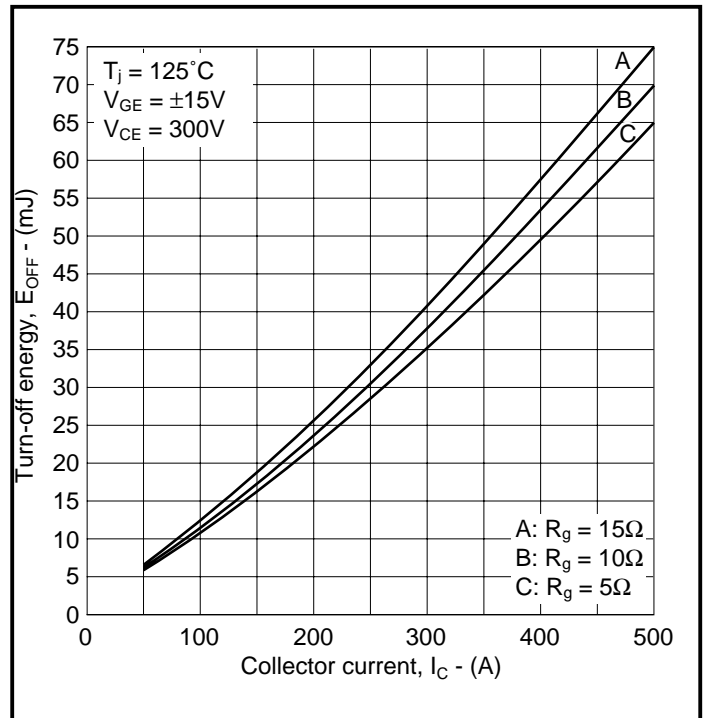

Fig.8 Typical turn-off energy vs collector current

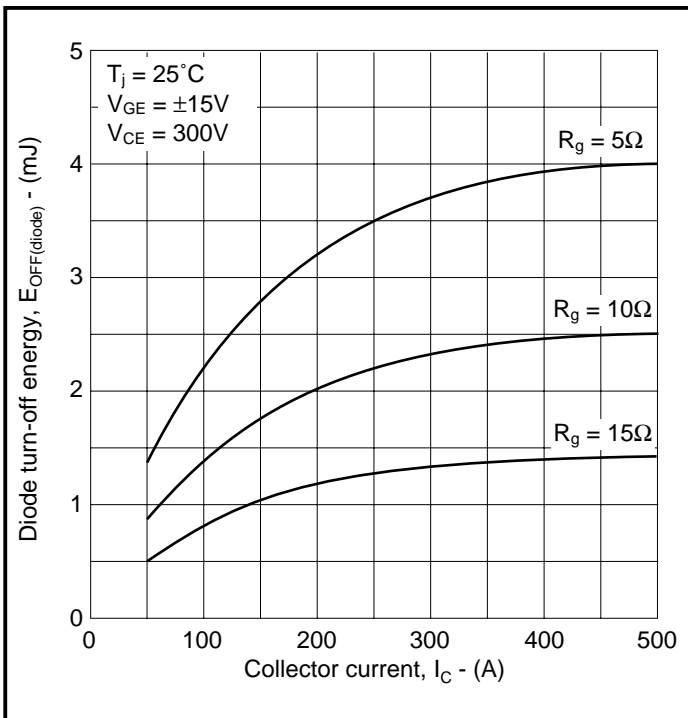

Fig.9 Typical diode turn-off energy vs collector current

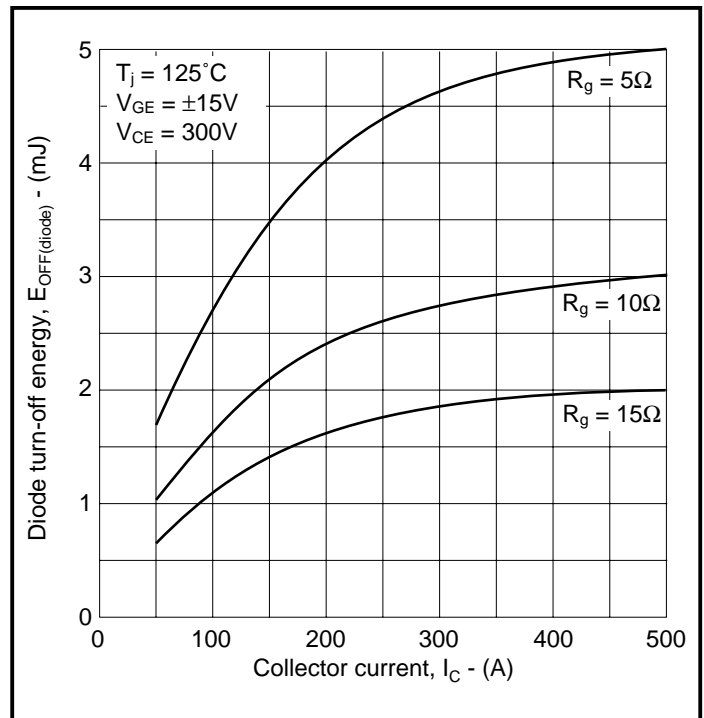
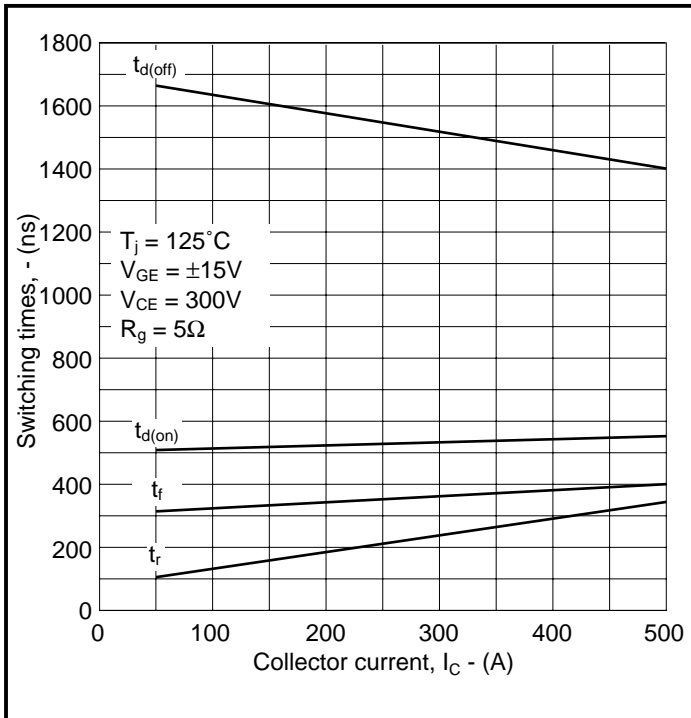
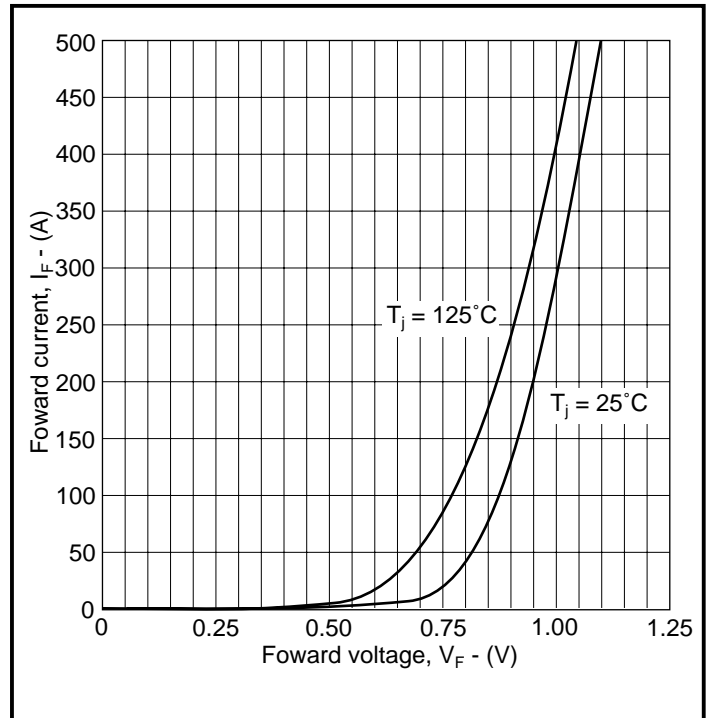

Fig.10 Typical diode turn-off energy vs collector current



**Fig.11 Typical switching characteristics**



**Fig.12 Diode typical forward characteristics**

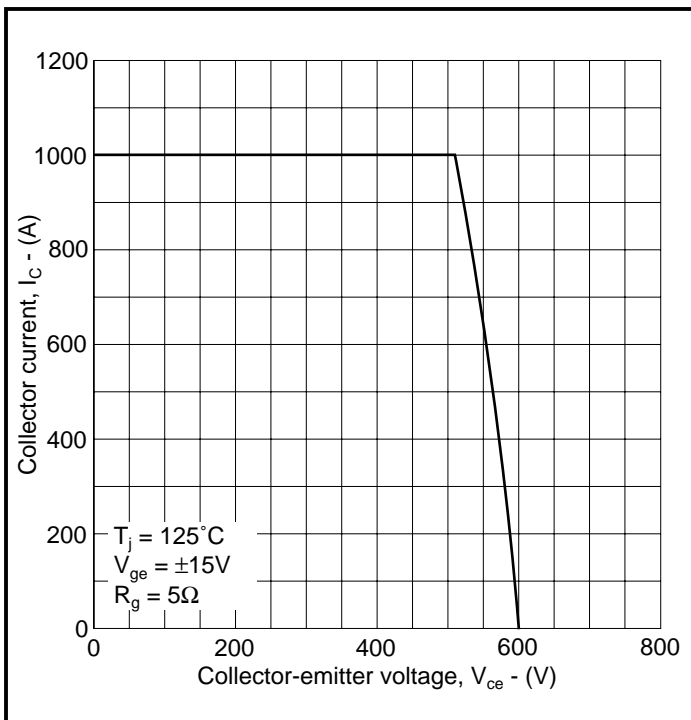

**Fig.13 Reverse bias safe operating area**

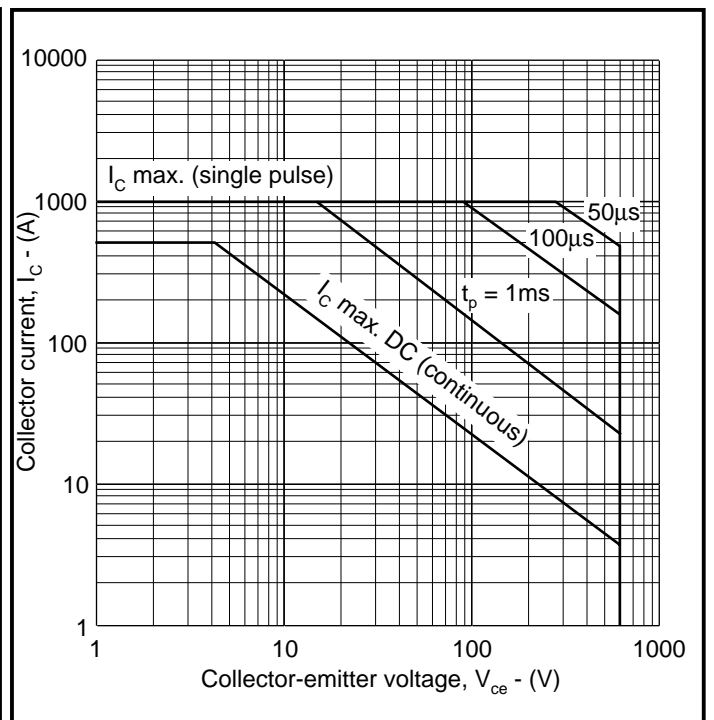

**Fig.14 Forward bias safe operating area (DC and single pulse)**

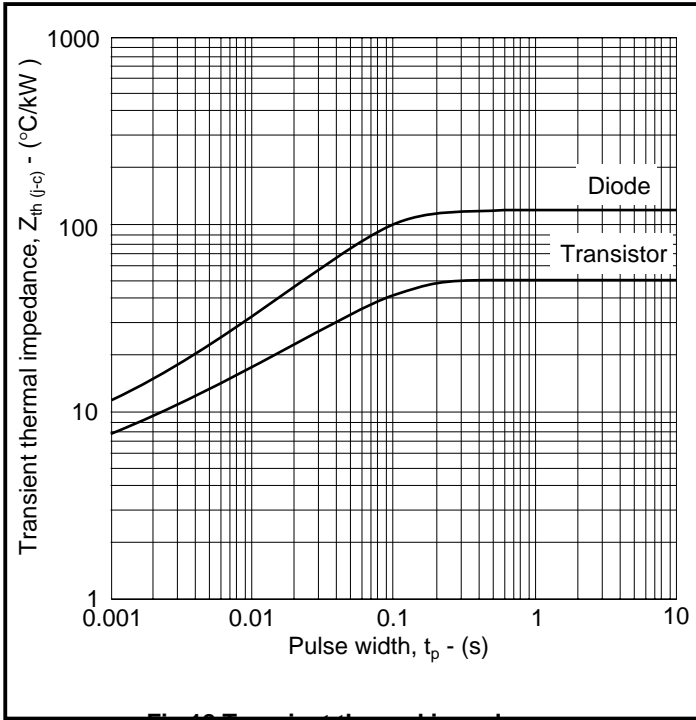

Fig.18 Transient thermal impedance





## POWER ASSEMBLY CAPABILITY

The Power Assembly group was set up to provide a support service for those customers requiring more than the basic semiconductor, and has developed a flexible range of heatsink and clamping systems in line with advances in device voltages and current capability of our semiconductors.

We offer an extensive range of air and liquid cooled assemblies covering the full range of circuit designs in general use today. The Assembly group continues to offer high quality engineering support dedicated to designing new units to satisfy the growing needs of our customers.

Using the latest CAD methods our team of design and applications engineers aim to provide the Power Assembly Complete Solution (PACs).

## HEATSINKS

The Power Assembly group has its own proprietary range of extruded aluminium heatsinks. They have been designed to optimise the performance of Dynex semiconductors. Data with respect to air natural, forced air and liquid cooling (with flow rates) is available on request.

For further information on device clamps, heatsinks and assemblies, please contact your nearest sales representative or customer service office.



<http://www.dynexsemi.com>

e-mail: [power\\_solutions@dynexsemi.com](mailto:power_solutions@dynexsemi.com)

**HEADQUARTERS OPERATIONS**  
**DYNEX SEMICONDUCTOR LTD**  
 Doddington Road, Lincoln.  
 Lincolnshire, LN6 3LF, United Kingdom.  
 Tel: 00-44-(0)1522-500500  
 Fax: 00-44-(0)1522-500550

**DYNEX POWER INC.**  
 99 Bank Street, Suite 410,  
 Ottawa, Ontario, Canada, K1P 6B9  
 Tel: 613.723.7035  
 Fax: 613.723.1518  
 Toll Free: 1.888.33.DYNEX (39639)

**CUSTOMER SERVICE CENTRES**  
**Mainland Europe** Tel: +33 (0)1 58 04 91 00. Fax: +33 (0)1 46 38 51 33  
**North America** Tel: (613) 723-7035. Fax: (613) 723-1518.  
**UK, Scandinavia & Rest Of World** Tel: +44 (0)1522 500500. Fax: +44 (0)1522 500020

**SALES OFFICES**  
**Mainland Europe** Tel: +33 (0)1 58 04 91 00. Fax: +33 (0)1 46 38 51 33  
**North America** Tel: (613) 723-7035. Fax: (613) 723-1518. Toll Free: 1.888.33.DYNEX (39639) /  
 Tel: (949) 733-3005. Fax: (949) 733-2986.  
**UK, Scandinavia & Rest Of World** Tel: +44 (0)1522 500500. Fax: +44 (0)1522 500020

These offices are supported by Representatives and Distributors in many countries world-wide.  
 © Dynex Semiconductor 2001 Publication No. DS4324-6 Issue No. 6.0 October 2001  
 TECHNICAL DOCUMENTATION – NOT FOR RESALE. PRINTED IN UNITED KINGDOM

### Datasheet Annotations:

Dynex Semiconductor annotate datasheets in the top right hand corner of the front page, to indicate product status. The annotations are as follows:-

**Target Information:** This is the most tentative form of information and represents a very preliminary specification. No actual design work on the product has been started.

**Preliminary Information:** The product is in design and development. The datasheet represents the product as it is understood but details may change.

**Advance Information:** The product design is complete and final characterisation for volume production is well in hand.

**No Annotation:** The product parameters are fixed and the product is available to datasheet specification.

This publication is issued to provide information only which (unless agreed by the Company in writing) may not be used, applied or reproduced for any purpose nor form part of any order or contract nor to be regarded as a representation relating to the products or services concerned. No warranty or guarantee express or implied is made regarding the capability, performance or suitability of any product or service. The Company reserves the right to alter without prior notice the specification, design or price of any product or service. Information concerning possible methods of use is provided as a guide only and does not constitute any guarantee that such methods of use will be satisfactory in a specific piece of equipment. It is the user's responsibility to fully determine the performance and suitability of any equipment using such information and to ensure that any publication or data used is up to date and has not been superseded. These products are not suitable for use in any medical products whose failure to perform may result in significant injury or death to the user. All products and materials are sold and services provided subject to the Company's conditions of sale, which are available on request.

All brand names and product names used in this publication are trademarks, registered trademarks or trade names of their respective owners.