

GP1A21

OPIC Photointerrupter with Connector

■ Features

1. Snap-in mounting type
2. Uses 3-pin connector terminal
3. High sensing accuracy (Slit width : 0.5mm)
4. Wide gap between light emitter and detector (5mm)

■ Applications

1. Copiers
2. Printers
3. Facsimiles

■ Outline Dimensions

(Unit : mm)

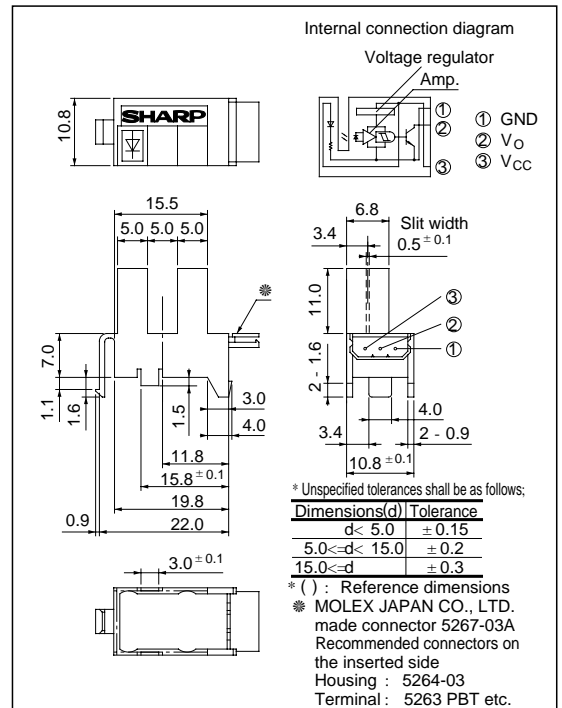

*** OPIC™ (Optical IC) is a trademark of the SHARP Corporation.

An OPIC consists of a light-detecting element and signal-processing circuit integrated onto a single chip.

Note) Terminal No. shown in the above figure is sometimes different from the number shown on the connector.

■ Absolute Maximum Ratings (T_a = 25°C)

Parameter	Symbol	Rating	Unit
Supply voltage	V _{CC}	- 0.5 to + 7	V
*1 Output voltage	V _O	- 0.5 to + 28	V
*2 Low level output current	I _{OL}	50	mA
*3 Operating temperature	T _{opr}	- 20 to + 75	°C
*3 Storage temperature	T _{stg}	- 30 to + 85	°C

*1 Collector-emitter voltage of output transistor

*2 Collector current of output transistor

*3 The connector should be plugged in/out and the unit's hook should be used at normal temperature.

■ Electro-optical Characteristics

(Unless otherwise specified, $V_{CC}= 5V$, $T_a= 25^{\circ}C$)

Parameter	Symbol	Conditions	MIN.	TYP.	MAX.	Unit
Operating supply voltage	V_{CC}		4.5	-	5.5	V
Low level supply current	I_{CCL}	Light beam uninterrupted	-	-	30	mA
Low level output voltage	V_{OL}	Light beam uninterrupted, $I_{OL}= 16mA$	-	-	0.35	V
High level supply current	I_{CCH}	Light beam interrupted	-	-	30	mA
High level output voltage	V_{OH}	Light beam interrupted, $R_L= 47k\Omega$	$V_{CC} \times 0.9$	-	-	V
*5 Response frequency	f	*4 $R_L= 47k\Omega$	-	-	3 000	Hz

*4 Output should not be DC level.

*5 Response frequency is measured with the disk shown below being rotated. (Unit: mm)

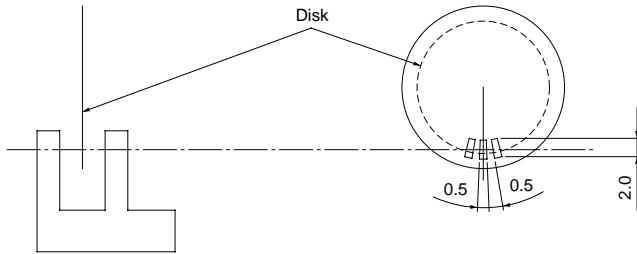

Fig. 1 Low Level Output Current vs. Ambient Temperature

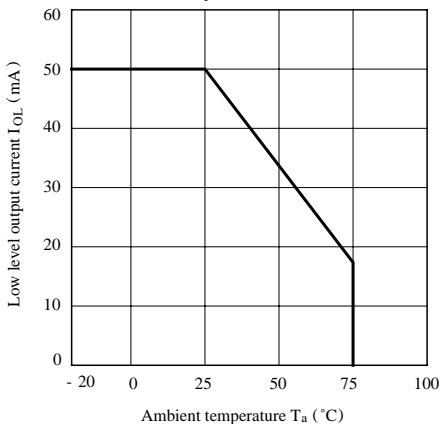

Fig. 2 Low Level Output Voltage vs. Low Level Output Current

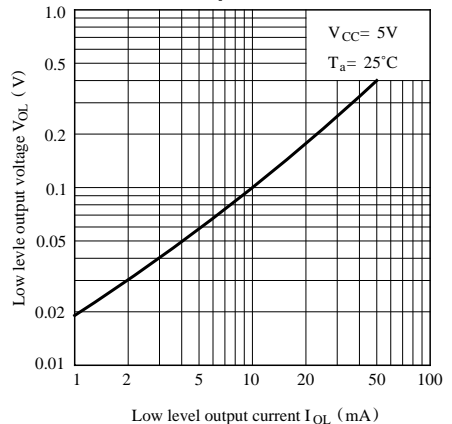

Fig. 3 Low Level Output Voltage vs. Ambient Temperature

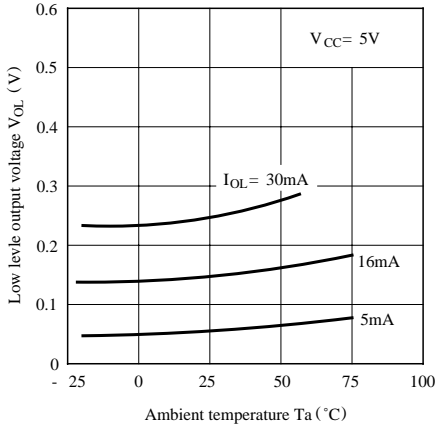

Fig. 4 Supply Current vs. Supply Voltage

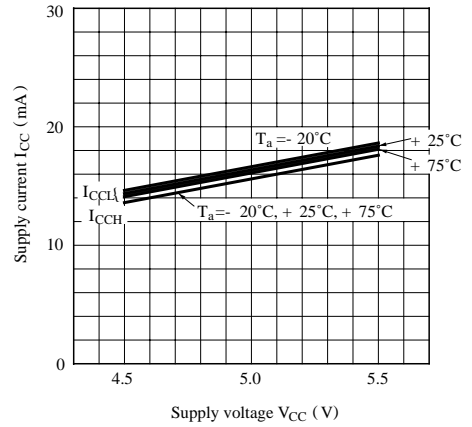

Fig. 5 Detecting Position Characteristics (1)

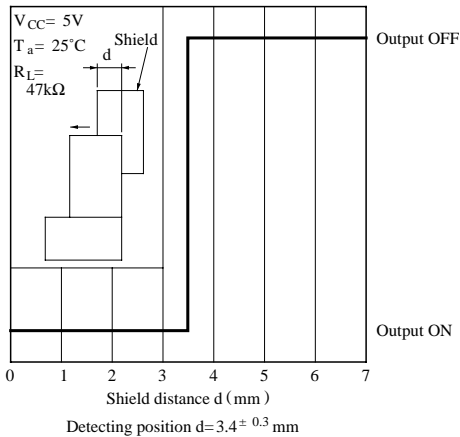
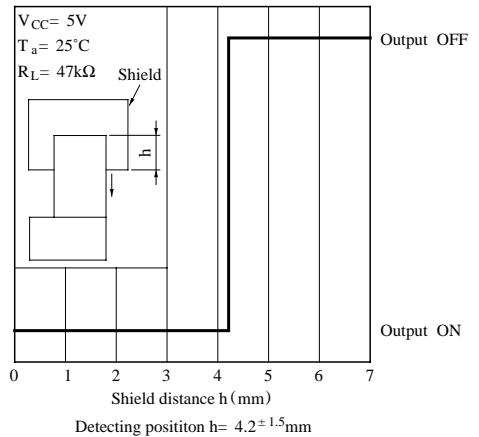
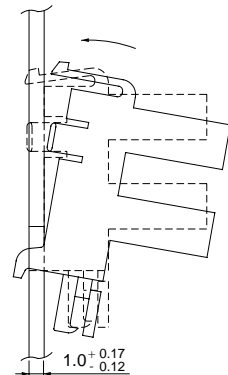

Fig. 6 Detecting Position Characteristics (2)



■ **Recommended Mounting Holes** (Following dimensions are recommended values, so confirm the intensity by using actual equipment before mounting.)



Mounting method

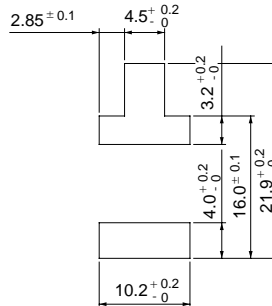

Recommended mounting holes (Unit : mm)

■ Precautions for Use

- (1) In this product, the PWB is fixed with a resin cover, and cleaning solvent may remain inside the case; therefore, dip cleaning or ultrasonic cleaning are prohibited.
- (2) Remove dust or stains, using an air blower or soft cloth moistened in cleaning solvent. However, do not perform the above cleaning using a soft cloth with cleaning solvent in the marking portion.
In this case use only the following type of cleaning solvent used for wiping off:
Ethyl alcohol, Methyl alcohol, Isopropyl alcohol.
When the cleaning solvents except for specified materials are used, please consult us.
- (3) In order to stabilize power supply line, connect a by-pass capacitor of more than $0.01\ \mu\text{F}$ between Vcc and GND near the device.
- (4) As for other general cautions, refer to the chapter “Precautions for Use”.