

DESCRIPTION

Dual center tap schottky rectifier designed for high frequency miniature Switched Mode Power Supplies.

Major Ratings and Characteristics

| Characteristics | Values | Unit |
|--|------------|------------------|
| $I_{F(AV)}$ Rectangular waveform | 2 X 10 | A |
| V_{RRM} | 125 | V |
| V_F @10 Apk, $T_C = 125^\circ\text{C}$ (per leg) | 0.68 | V |
| T_J range | -45 ~ +150 | $^\circ\text{C}$ |

FEATURES

- ◆ High junction temperature capability
- ◆ Good trade off between leakage current and forward voltage drop
- ◆ Low leakage current

TO-220AB

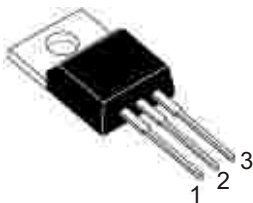

TO-263-2(D²PAK)

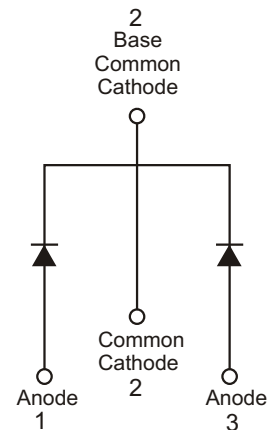
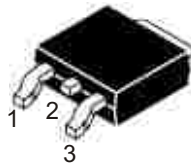

TO-220FPAB

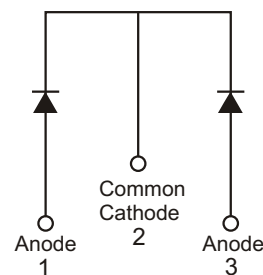
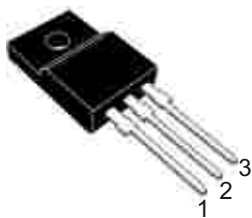

◆ MARKING INFORMATION

TO - 220AB



TO-263-2 (D²PAK)

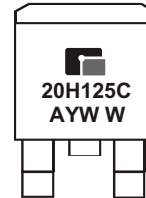

A : Assembly Location
 Y : Year
 WW : Weekly

◆ ORDERING INFORMATION

| Ordering Number | Package | Shipping |
|-----------------|--------------|-----------------------|
| GMR20H125CTA3T | TO - 263-2 | 50 Unit/ Tube |
| GMR20H125CTA3R | TO - 263-2 | 800 Unit/ Tape & Reel |
| GMR20H125CTB3T | TO - 220AB | 50 Unit/ Tube |
| GMR20H125CTBF3T | TO - 220FPAB | 50 Unit/ Tube |

* For detail Ordering Number identification, please see last page.

◆ ABSOLUTE RATINGS (T_C = 25°C)

| Symbol | Parameter | Value | Unit |
|-----------------------------------|---|-------------------------------------|------|
| V _{RRM} | Repetitive peak reverse voltage | 125 | V |
| I _{F(AV)} | Maximum average forward rectified current | per diode 10 per device 20 | A |
| I _{FSM} | Peak forward surge current 8.3ms single half sine-wave superimposed on rated load per leg. (Non-Repetitive) | 200 | A |
| T _j , T _{stg} | Operating junction temperature and storage temperature | -45 to + 150 | °C |

HIGH VOLTAGE POWER SCHOTTKY RECTIFIER

◆ **Thermal Characteristics** ($T_C = 25^\circ\text{C}$ unless otherwise noted)

| Parameter | Symbol | TO-263-2 | TO-220AB | TO-220FPAB | Unit |
|------------------------------------|-----------------|----------|----------|------------|--------------------|
| Typical thermal resistance per leg | $R_{\theta JC}$ | 2.0 | 2.0 | 4.0 | $^\circ\text{C/W}$ |

◆ **Electrical Characteristics** ($T_C = 25^\circ\text{C}$ unless otherwise noted)

| Parameter | Symbol | Value | Unit |
|--|---|-------|---------------|
| Maximum instantaneous forward voltage per leg (Note 1) | $I_F = 10\text{A}, T_C = 25^\circ\text{C}$ | 0.80 | V |
| | $I_F = 10\text{A}, T_C = 125^\circ\text{C}$ | 0.68 | |
| | $I_F = 20\text{A}, T_C = 25^\circ\text{C}$ | - | |
| | $I_F = 20\text{A}, T_C = 125^\circ\text{C}$ | - | |
| Maximum reverse current per leg at working peak reverse voltage (Note 1) | $T_J = 25^\circ\text{C}$ | 10 | μA |
| | $T_J = 125^\circ\text{C}$ | 10 | mA |

Note 1: Pulse Test: Pulse Width= 300 μs , Duty Cycle $\leq 2.0\%$

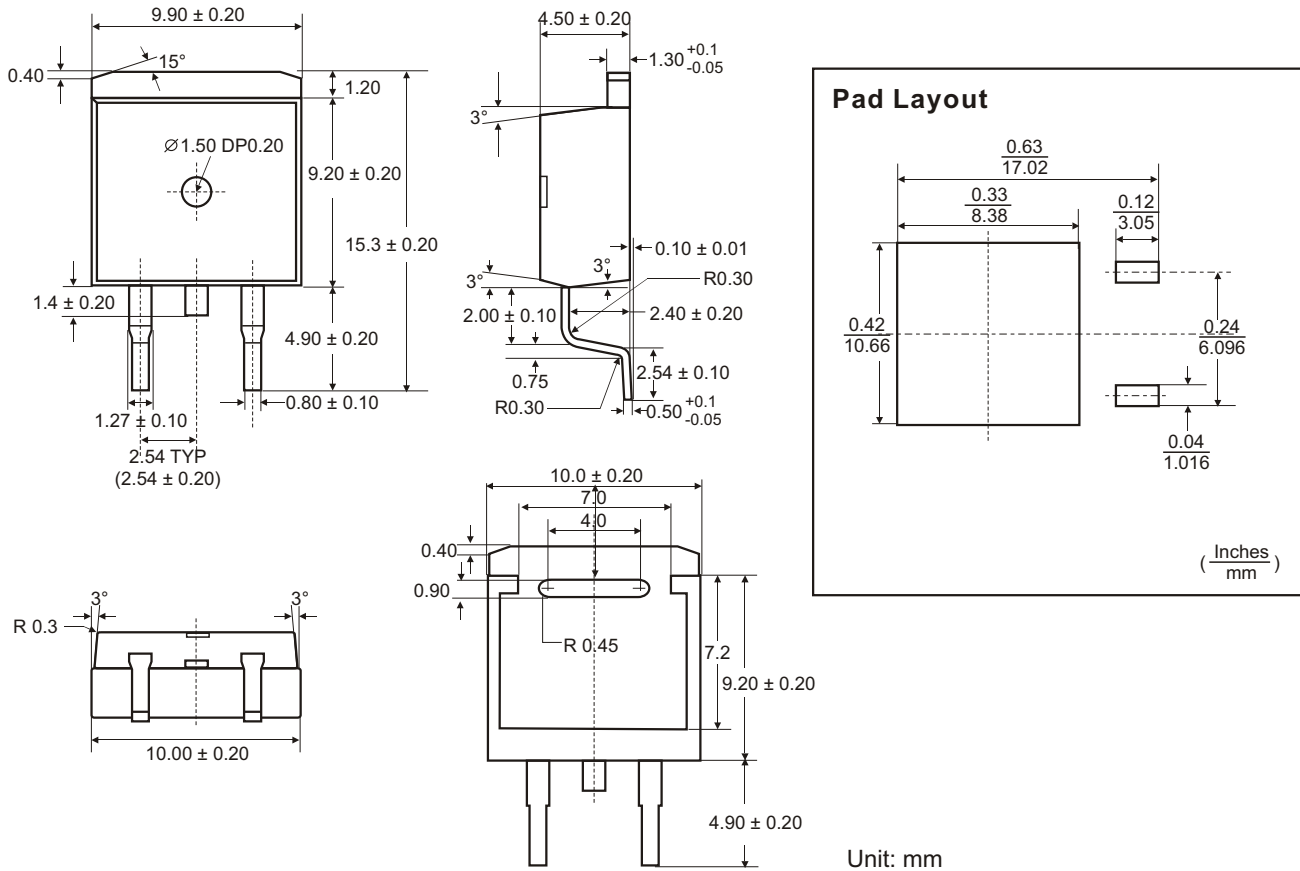

HIGH VOLTAGE POWER SCHOTTKY RECTIFIER

◆ TO-263-2 PACKAGE OUTLINE DIMENSIONS

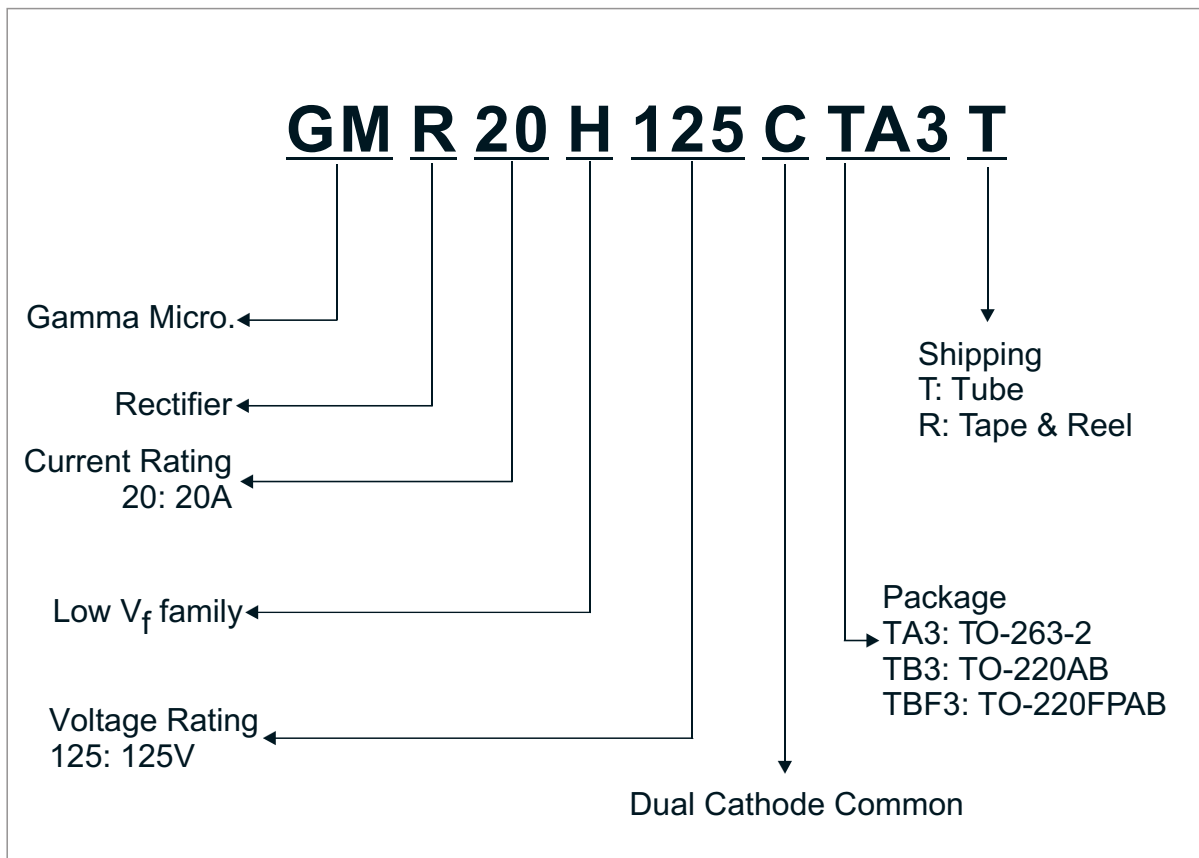

◆ ORDERING NUMBER



GAMMA Micro, , and  are registered trademarks of GAMMA MICROELECTRONICS INC. GAMMA reserves the right to make changes without further notice to any products herein. Information provided herein is alleged to be exact and consistent and this publication surpasses and replaces all information previously supplied.

GAMMA makes no warranty the suitability of its products for any particular purpose, nor does GAMMA assume any liability arising out of the application or use of any product or circuit, and specifically disclaims any and all liability including without limitation special, consequential or incidental damages.

GAMMA products are not authorized for using as critical components in life support devices or systems without prior written approval from GAMMA MICROELECTRONICS INC.
