

GL560/GL561

Low Peak Forward Voltage Type φ 5 Resin Mold Package Infrared Emitting Diodes

■ Features

1. Low peak forward voltage suitable for battery drive
(V_{FM} : TYP.1.7V at I_{FM} : 0.5A)
2. φ 5 resin mold package

■ Applications

1. Infrared remote controllers for TVs, VCRs,
audio equipment and air conditioners

■ Model Lineup

Model	GL560	GL561
Radiant intensity TYP. (mW/sr)	14	25
Half intensity angle TYP. (°)	± 21	± 13

■ Absolute Maximum Ratings

(Ta=25°C)

Parameter	Symbol	Rating	Unit
Forward current	I_F	100	mA
*1 Peak forward current	I_{FM}	1	A
Reverse voltage	V_R	6	V
Power dissipation	P	150	mW
Operating temperature	T_{opr}	- 25 to + 85	°C
*2 Storage temperature	T_{stg}	- 40 to + 85	°C
Soldering temperature	T_{sol}	260	°C

*1 Pulse width <=100μs, Duty ratio=0.01

*2 For 10 seconds at the position of 2.6 mm from the resin edge

■ Electro-optical Characteristics

(Ta=25°C)

Parameter	Symbol	Conditions	MIN.	TYP.	MAX.	Unit
Forward voltage	V_F	$I_F = 50\text{mA}$	-	1.25	1.37	V
Peak forward voltage	V_{FM}	$I_{FM} = 0.5\text{A}$	-	1.7	2.5	V
Reverse current	I_R	$V_R = 3\text{V}$	-	-	10	μA
*3 Radiant intensity	GL560	$I_F = 50\text{mA}$	5	14	-	mW/sr
	GL561		12	25	-	
Peak emission wavelength	λ_p	$I_F = 5\text{mA}$	-	940	-	nm
Half intensity wavelength	$\Delta\lambda$	$I_F = 5\text{mA}$	-	45	-	nm
Terminal capacitance	C_t	$V_R = 0, f = 1\text{MHz}$	-	50	-	pF
Response frequency	f_c	-	-	300	-	kHz
Half intensity angle	GL560	$I_F = 20\text{mA}$	-	± 21	-	°
	GL561		-	± 13	-	

*3 I_E : Value obtained by converting the value in power of radiant fluxes emitted at the solid angle of 0.01 sr (steradian) in the direction of mechanical axis of the lens portion into 1 sr or all those emitted from the light emitting diode.

■ Outline Dimensions

(Unit : mm)

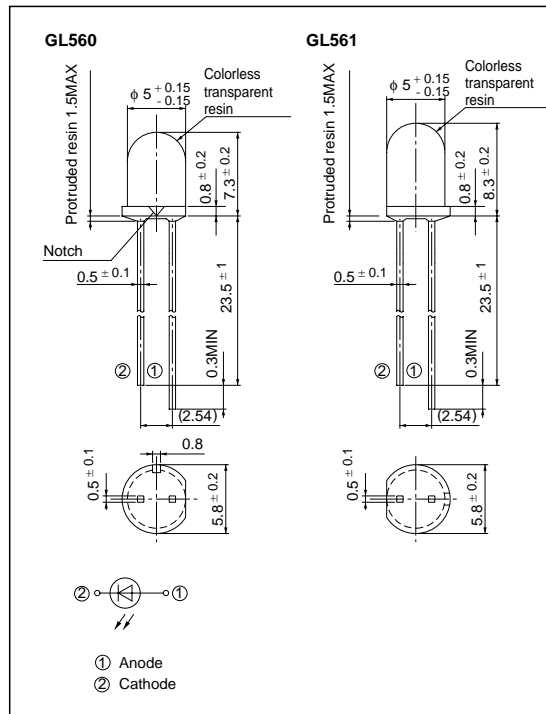

Fig. 1 Forward Current vs. Ambient Temperature

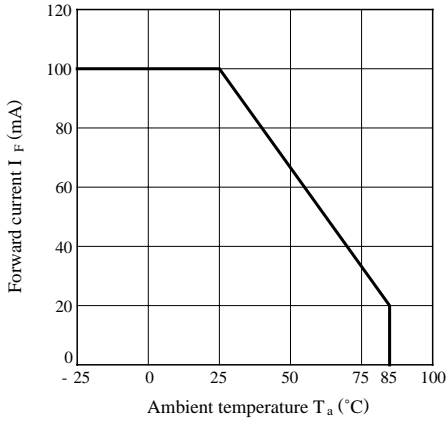

Fig. 2 Peak Forward Current vs. Duty Ratio

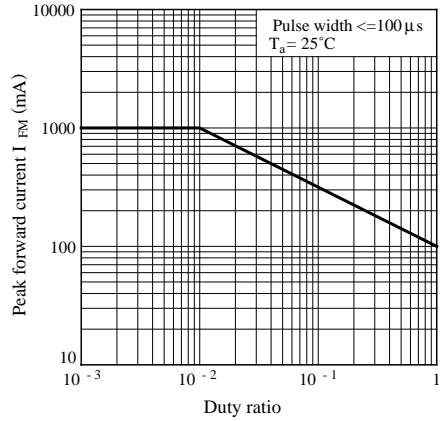

Fig. 3 Spectral Distribution

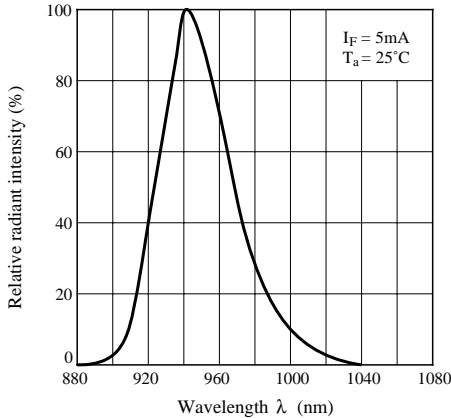

Fig. 4 Peak Emission Wavelength vs. Ambient Temperature

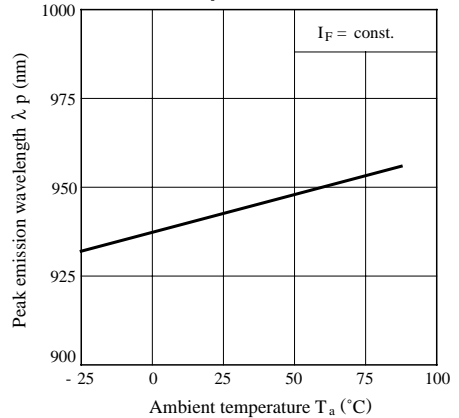

Fig. 5 Forward Current vs. Forward Voltage

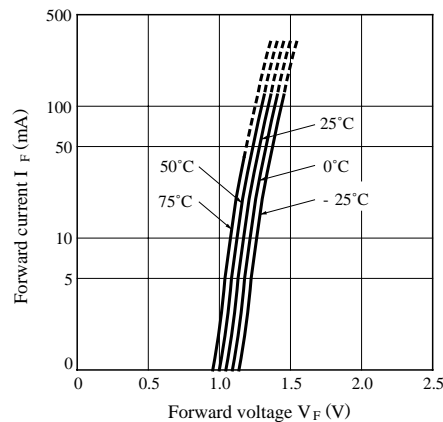

Fig. 6 Relative Forward Voltage vs. Ambient Temperature

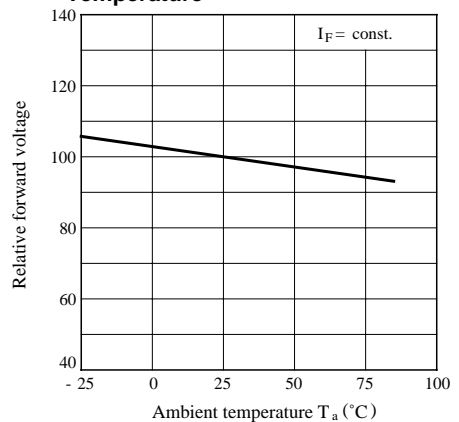

Fig. 7 Relative Radiant Output vs. Ambient Temperature (Detector : PD410PI)

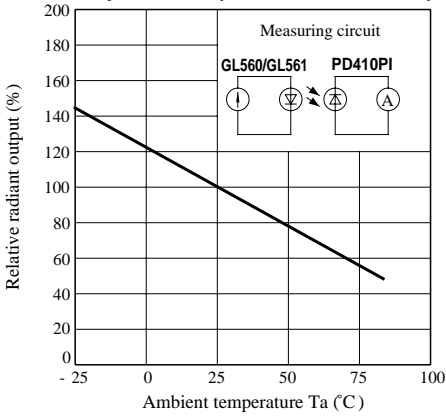

Fig. 8 Radiant Intensity vs. Forward Current

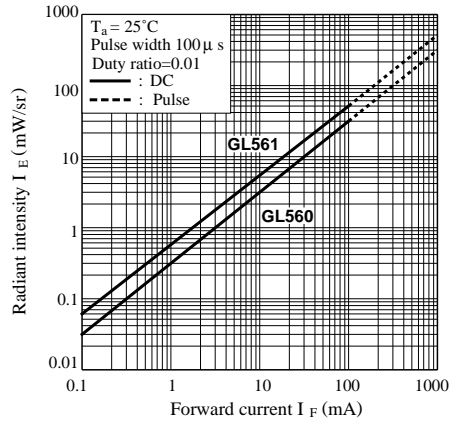

Fig. 9 Relative Output vs. Distance (Detector : PD410PI)

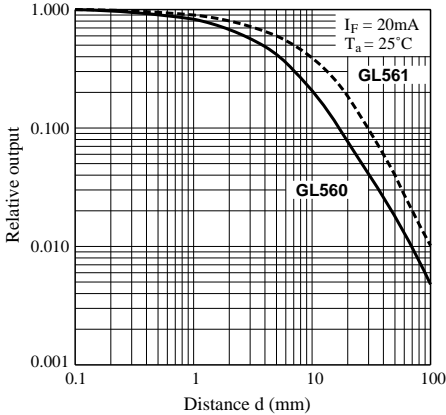

Fig. 10 Relative Output vs. Distance (Detector : PD49PI)

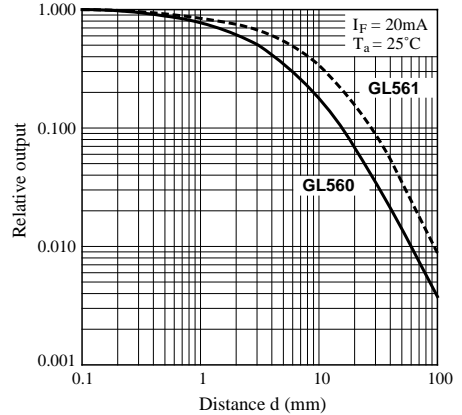

Fig. 11-a Radiation Diagram (GL560)

($T_a = 25^\circ\text{C}$)

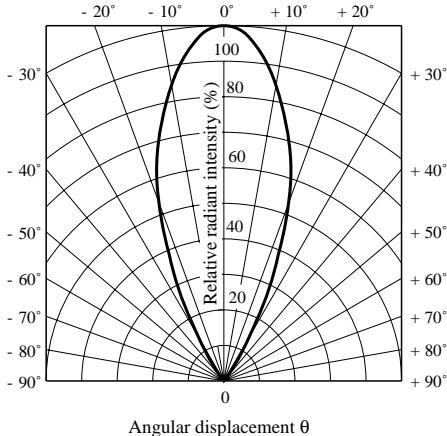

Fig. 11-b Radiation Diagram (GL561)

($T_a = 25^\circ\text{C}$)

