

IGBT PIM MODULE

Features

- Low VCE (on) Non Punch Through IGBT Technology
- Low Diode VF
- 10µs Short Circuit Capability
- Square RBSOA
- HEXFRED Antiparallel Diode with Ultrasoft Diode Reverse Recovery Characteristics
- Positive VCE (on) Temperature Coefficient
- Ceramic DBC Substrate
- Low Stray Inductance Design

Benefits

- Benchmark Efficiency for Motor Control
- Rugged Transient Performance
- Low EMI, Requires Less Snubbing
- Direct Mounting to Heatsink
- PCB Solderable Terminals
- Low Junction to Case Thermal Resistance
- UL Listed ①

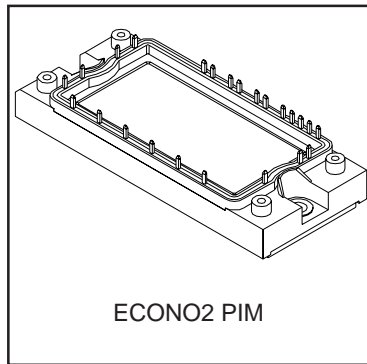

$V_{CES} = 1200V$

$I_C = 15A, T_C=80^{\circ}C$

$t_{sc} > 10\mu s, T_J=150^{\circ}C$

$V_{CE(on)} \text{ typ.} = 2.55V$

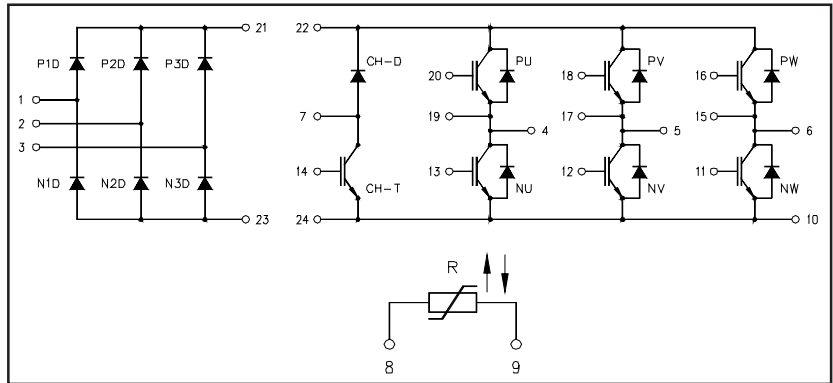

Absolute Maximum Ratings ($T_J = 25^{\circ}C$, unless otherwise indicated)

	Parameter	Symbol	Test Conditions		Rated	Units
Inverter	Collector-to-Emitter Voltage	V_{CES}			1200	V
	Gate-to-Emitter Voltage	V_{GES}			± 20	
	Collector Current	I_C	Continuous	$25^{\circ}C / 80^{\circ}C$	25 / 15	A
				$25^{\circ}C$	50	
	Diode Maximum Forward Current	$I_{FM} \text{ } \textcircled{\varnothing}$			50	
	Power Dissipation	P_D	1 device	$25^{\circ}C$	125	W
Input Rectifier	Repetitive Peak Reverse Voltage	V_{RRM}			1600	V
	Average Output Current	$I_{F(AV)}$	50/60Hz sine pulse	$80^{\circ}C$	15	A
	Surge Current (Non Repetitive)	I_{FSM}	Rated V_{RRM} applied, 10ms, sine pulse		120	
	I^2t (Non Repetitive)	I^2t			72	A ² s
Brake	Collector-to-Emitter Voltage	V_{CES}			1200	V
	Gate-to-Emitter Voltage	V_{GES}			± 20	
	Collector Current	I_C	Continuous	$25^{\circ}C / 80^{\circ}C$	15 / 7.5	A
				$25^{\circ}C$	30	
	Power Dissipation	P_D	1 device	$25^{\circ}C$	83	W
	Repetitive Peak Reverse Voltage	V_{RRM}			1200	V
	Maximum Operating Junction Temperature	T_J			150	$^{\circ}C$
	Storage Temperature Range	T_{STG}			-40 to +125	
	Isolation Voltage	V_{ISOL}	AC (1min.)		2500	V

Thermal and Mechanical Characteristics

Parameter	Symbol	Min	Typical	Maximum	Units
Junction-to-Case Inverter IGBT Thermal Resistance	R_{THJC}	—	—	1.0	$^{\circ}C/W$
Junction-to-Case Inverter FRED Thermal Resistance		—	—	1.6	
Junction-to-Case Brake IGBT Thermal Resistance		—	—	1.5	
Junction-to-Case Diode Thermal Resistance		—	—	2.3	
Junction-to-Case Input Rectifier Thermal Resistance		—	—	1.0	
Mounting Torque (M5)		2.7	—	3.3	Nm

Electrical Characteristics @ T_J = 25°C (unless otherwise specified)

		Parameter	Min.	Typ.	Max.	Units	Conditions	Ref. Fig
Inverter IGBT	BV _{CES}	Collector-to-Emitter Breakdown Voltage	1200	—	—	V	V _{GE} = 0V, I _C = 500μA	
	ΔV _{(BR)CES/ΔT_J}	Temperature Coeff. of Breakdown Voltage	—	1.1	—	V/°C	V _{GE} = 0V, I _C = 1mA (25°C-125°C)	
	V _{CE(on)}	Collector-to-Emitter Voltage	—	2.55	2.80	V	I _C = 15A, V _{GE} = 15V	1,2
			—	3.15	3.50		I _C = 25A, V _{GE} = 15V	4,5
			—	3.05	—		I _C = 15A, V _{GE} = 15V, T _J = 125°C	
			—	3.85	—		I _C = 25A, V _{GE} = 15V, T _J = 125°C	
	V _{GE(th)}	Gate Threshold Voltage	4.0	5.0	6.0		V _{CE} = V _{GE} , I _C = 250μA	3,4,5
	ΔV _{GE(th)}	Threshold Voltage temp. coefficient	—	-11	—	mV/°C	V _{CE} = V _{GE} , I _C = 1mA (25°C-125°C)	
	I _{CES}	Zero Gate Voltage Collector Current	—	8	50	μA	V _{GE} = 0V, V _{CE} = 1200V	
			—	370	—		V _{GE} = 0V, V _{CE} = 1200V, T _J = 125°C	
	I _{GES}	Gate-to-Emitter Leakage Current	—	—	±200	nA	V _{GE} = ±20V	
	Q _g	Total Gate Charge (turn-on)	—	95	145	nC	I _C = 15A	7
	Q _{ge}	Gate-to-Emitter Charge (turn-on)	—	10	15		V _{CC} = 400V	CT1
	Q _{gc}	Gate-to-Collector Charge (turn-on)	—	45	70		V _{GE} = 15V	
	E _{on}	Turn-On Switching Loss	—	1300	2300	μJ	I _C = 15A, V _{CC} = 600V	CT4
	E _{off}	Turn-Off Switching Loss	—	900	1550		V _{GE} = 15V, R _G = 22Ω, L = 400μH	
	E _{tot}	Total Switching Loss	—	2200	3850		T _J = 25°C ⊕	
	E _{on}	Turn-On Switching Loss	—	1700	2850	μJ	I _C = 15A, V _{CC} = 600V	9,11
	E _{off}	Turn-Off Switching Loss	—	1250	1900		V _{GE} = 15V, R _G = 22Ω, L = 400μH	CT4
	E _{tot}	Total Switching Loss	—	2950	4750		T _J = 125°C ⊕	WF1,2
t _{d(on)}	Turn-On delay time	—	50	65	ns	I _C = 15A, V _{CC} = 600V	10,12	
t _r	Rise time	—	50	70		V _{GE} = 15V, R _G = 22Ω, L = 400μH	CT4	
t _{d(off)}	Turn-Off delay time	—	300	540		T _J = 125°C	WF1	
t _f	Fall time	—	220	286			WF2	
C _{ies}	Input Capacitance	—	1285	—	pF	V _{GE} = 0V	6	
C _{oes}	Output Capacitance	—	280	—		V _{CC} = 30V		
C _{res}	Reverse Transfer Capacitance	—	35	—		f = 1Mhz		
RBSOA	Reverse Bias Safe Operating Area	FULL SQUARE				T _J = 150°C, I _C = 50A R _G = 22Ω, V _{GE} = +15V to 0V	CT2	
SCSOA	Short Circuit Safe Operating Area	10	—	—	μs	T _J = 150°C V _{CC} = 900V, V _P = 1200V R _G = 22Ω, V _{GE} = +15V to 0V	CT3	
Inverter FRED	I _{rr}	Diode Peak Reverse Recovery Current	—	22	—	A	T _J = 125°C V _{CC} = 600V, I _F = 15A, L = 400μH V _{GE} = 15V, R _G = 22Ω	13,14,15 CT4
			V _{FM}	Diode Forward Voltage Drop	—		2.15	2.55
—	—	2.60	3.05	I _F = 25A				
—	—	2.30	—	I _F = 15A, T _J = 125°C				
—	—	2.90	—	I _F = 25A, T _J = 125°C				

Electrical Characteristics @ T_J = 25°C (unless otherwise specified)

	Parameter	Min.	Typ.	Max.	Units	Conditions	Ref. Fig	
Input Rectifier	V _{FM}	Maximum Forward Voltage Drop	—	—	1.3	V	I _F = 15A	17
	I _{RM}	Maximum Reverse Leakage Current	—	—	0.05	mA	T _J = 25°C, V _R = 1600V	
			—	—	1.0		T _J = 150°C, V _R = 1600V	
	r _T	Forward Slope Resistance	—	—	16.4	mΩ	T _J = 150°C	
V _{F(TO)}	Conduction Threshold Voltage	—	—	0.77	V			
Brake IGBT	BV _{CES}	Collector-to-Emitter Breakdown Voltage	1200	—	—	V	V _{GE} = 0V, I _C = 500μA	
	ΔV _{(BR)CES} /ΔT _J	Temperature Coeff. of Breakdown Voltage	—	1.5	—	V/°C	V _{GE} = 0V, I _C = 1mA (25°C-125°C)	
	V _{CE(on)}	Collector-to-Emitter Voltage	—	2.35	2.50		I _C = 7.5A, V _{GE} = 15V	20,21
			—	3.10	3.30		I _C = 15A, V _{GE} = 15V	23,24
			—	2.75	—		I _C = 7.5A, V _{GE} = 15V, T _J = 125°C	
			—	3.80	—		I _C = 15A, V _{GE} = 15V, T _J = 125°C	
	V _{GE(th)}	Gate Threshold Voltage	4.0	5.0	6.0		V _{CE} = V _{GE} , I _C = 250μA	22,23,24
	ΔV _{GE(th)}	Threshold Voltage temp. coefficient	—	-10	—	mV/°C	V _{CE} = V _{GE} , I _C = 1mA (25°C-125°C)	
	I _{CES}	Zero Gate Voltage Collector Current	—	8	50	μA	V _{GE} = 0V, V _{CE} = 1200V	
			—	350	—		V _{GE} = 0V, V _{CE} = 1200V, T _J = 125°C	
	I _{GES}	Gate-to-Emitter Leakage Current	—	—	±200	nA	V _{GE} = ±20V	
	Q _g	Total Gate Charge (turn-on)	—	55	85	nC	I _C = 7.5A	26
	Q _{ge}	Gate-to-Emitter Charge (turn-on)	—	24	40		V _{CC} = 600V	CT1
	Q _{gc}	Gate-to-Collector Charge (turn-on)	—	7	15		V _{GE} = 15V	
	E _{on}	Turn-On Switching Loss	—	700	800	μJ	I _C = 7.5A, V _{CC} = 600V	CT4
	E _{off}	Turn-Off Switching Loss	—	350	450		V _{GE} = 15V, R _G = 47Ω, L = 200μH	
	E _{tot}	Total Switching Loss	—	1050	1250		T _J = 25°C ③	
	E _{on}	Turn-On Switching Loss	—	975	1150	μJ	I _C = 7.5A, V _{CC} = 600V	28,30
	E _{off}	Turn-Off Switching Loss	—	525	900		V _{GE} = 15V, R _G = 47Ω, L = 200μH	CT4
	E _{tot}	Total Switching Loss	—	1500	2050		T _J = 125°C ③	WF3,4
	t _{d(on)}	Turn-On delay time	—	50	65	ns	I _C = 7.5A, V _{CC} = 600V	29,31
t _r	Rise time	—	45	65	V _{GE} = 15V, R _G = 47Ω, L = 200μH		CT4	
t _{d(off)}	Turn-Off delay time	—	365	400	T _J = 125°C		WF3	
t _f	Fall time	—	135	180			WF4	
C _{ies}	Input Capacitance	—	740	—	pF	V _{GE} = 0V	25	
C _{oes}	Output Capacitance	—	95	—		V _{CC} = 30V		
C _{res}	Reverse Transfer Capacitance	—	20	—		f = 1Mhz		
RBSOA	Reverse Bias Safe Operating Area	FULL SQUARE				T _J = 150°C, I _C = 30A R _G = 47Ω, V _{GE} = +15V to 0V	CT2	
SCSOA	Short Circuit Safe Operating Area	10	—	—	μs	T _J = 150°C V _{CC} = 900V, V _P = 1200V R _G = 47Ω, V _{GE} = +15V to 0V	CT3	
Brake Diode	I _{rr}	Diode Peak Reverse Recovery Current	—	13	—	A	V _{CC} = 600V, I _F = 7.5A, L = 400μH V _{GE} = 15V, R _G = 47Ω, T _J = 125°C	32,33,34 CT4
	V _{FM}	Diode Forward Voltage Drop	—	1.90	2.10	V	I _F = 7.5A	27
			—	2.40	2.70		I _F = 15A	
			—	2.00	—		I _F = 7.5A, T _J = 125°C	
—			2.65	—	I _F = 15A, T _J = 125°C			
NTC	R	Resistance	4538	5000	5495	Ω	T _J = 25°C	16
			468.6	493.3	518.0		T _J = 100°C	
	B	B Value	3307	3375	3443	K	T _J = 25 / 50 °C	

Note:

- ① For UL Application, T_J is limited to +125°C (See File 78996).
- ② Power dependent on temperature. T_J not to exceed T_{JMAX}
- ③ Energy losses include "tail" and diode reverse recovery.

Inverter

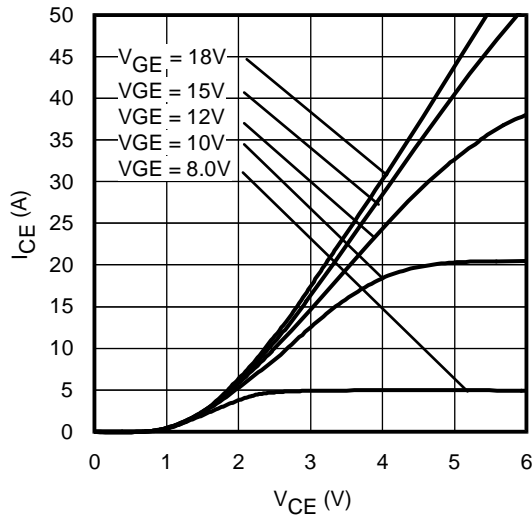

Fig. 1 - Typ. IGBT Output Characteristics
 $T_J = 25^\circ\text{C}$; $t_p = 80\mu\text{s}$

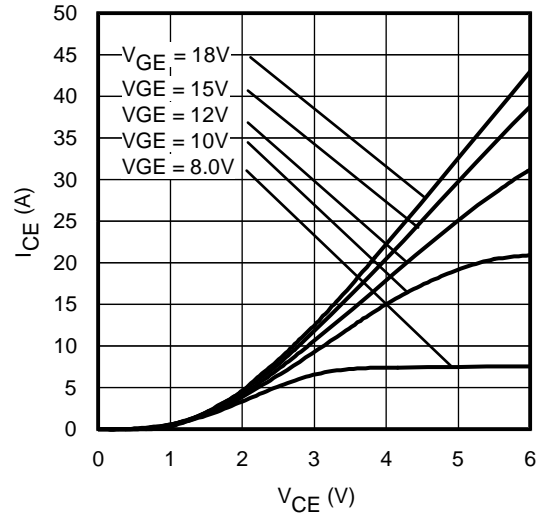

Fig. 2 - Typ. IGBT Output Characteristics
 $T_J = 125^\circ\text{C}$; $t_p = 80\mu\text{s}$

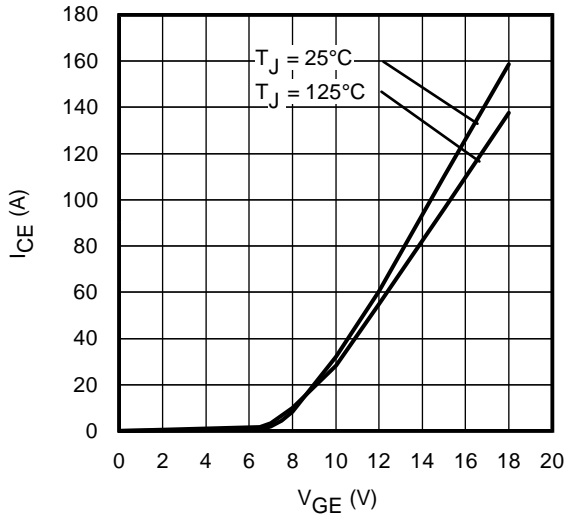

Fig. 3 - Typ. Transfer Characteristics
 $V_{CE} = 50\text{V}$; $t_p = 10\mu\text{s}$

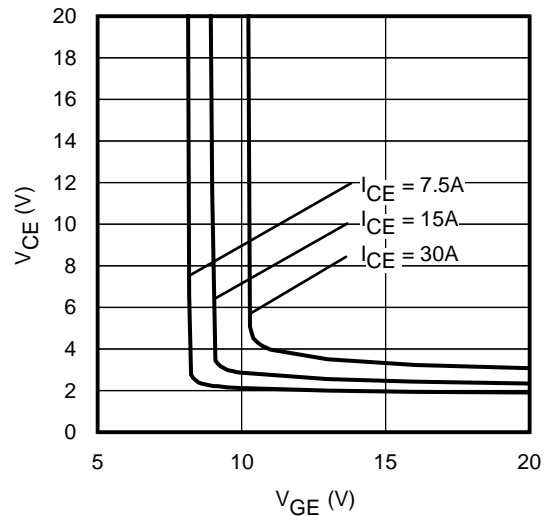

Fig. 4 - Typical V_{CE} vs. V_{GE}
 $T_J = 25^\circ\text{C}$

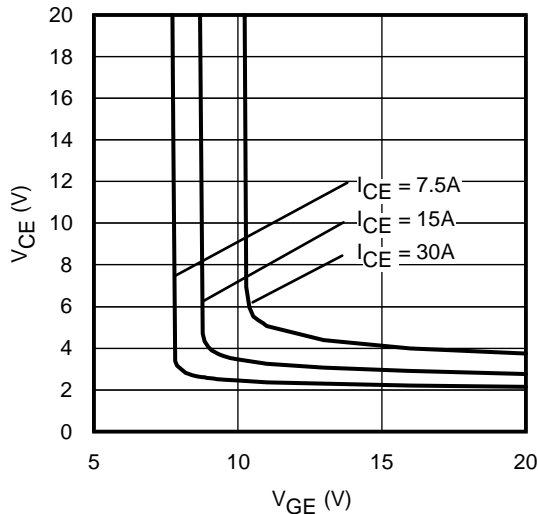

Fig. 5 - Typical V_{CE} vs. V_{GE}
 $T_J = 125^\circ\text{C}$

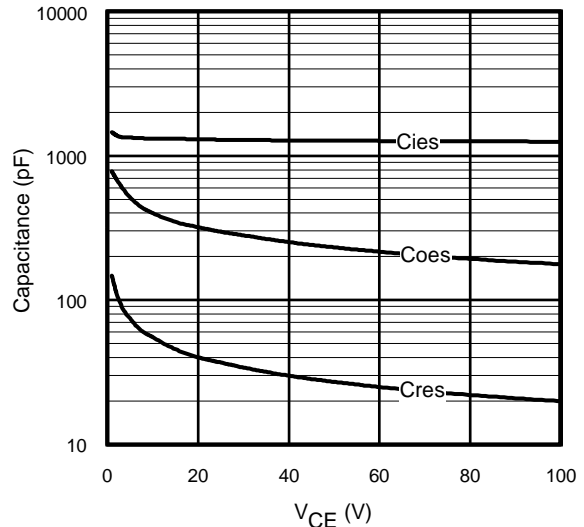

Fig. 6 - Typ. Capacitance vs. V_{CE}
 $V_{GE} = 0\text{V}$; $f = 1\text{MHz}$

Inverter

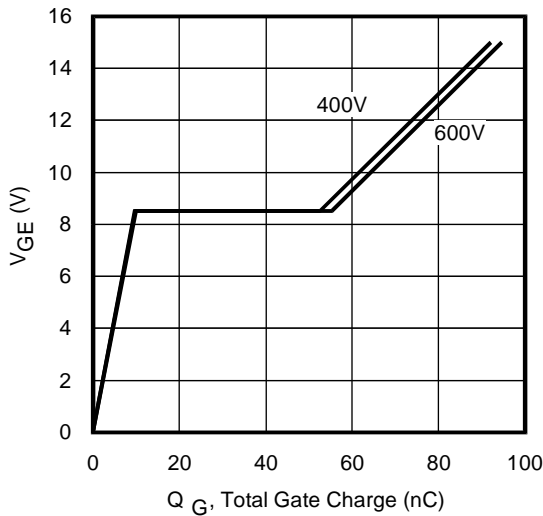

Fig. 7 - Typical Gate Charge vs. V_{GE}
 $I_{CE} = 15A$; $L = 1.0mH$

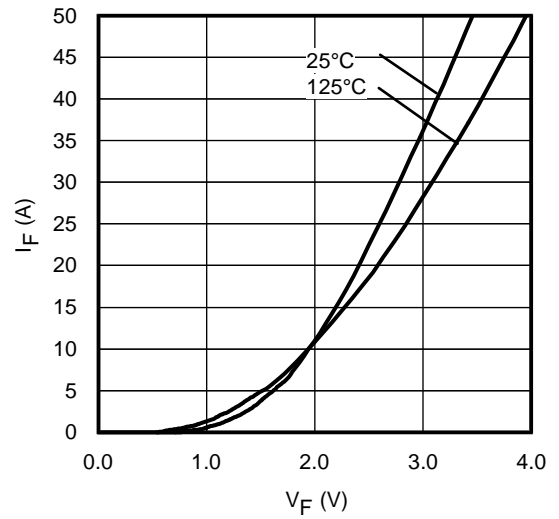

Fig. 8 - Typ. Diode Forward Characteristics
 $t_p = 80\mu s$

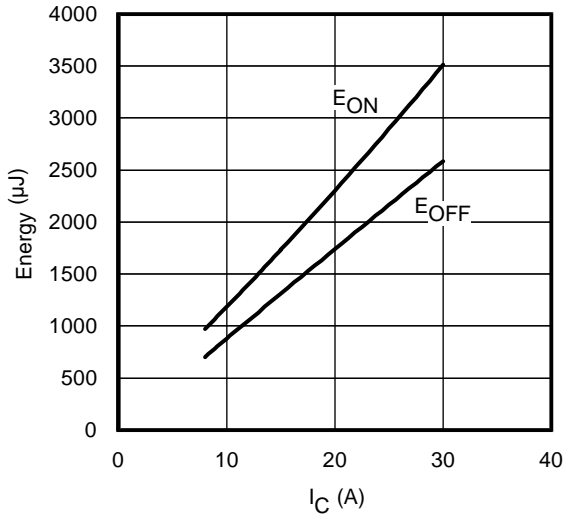

Fig. 9 - Typ. Energy Loss vs. I_C

$T_J = 125^\circ C$; $L=400\mu H$; $V_{CE}= 600V$, $R_G= 22\Omega$; $V_{GE}= 15V$

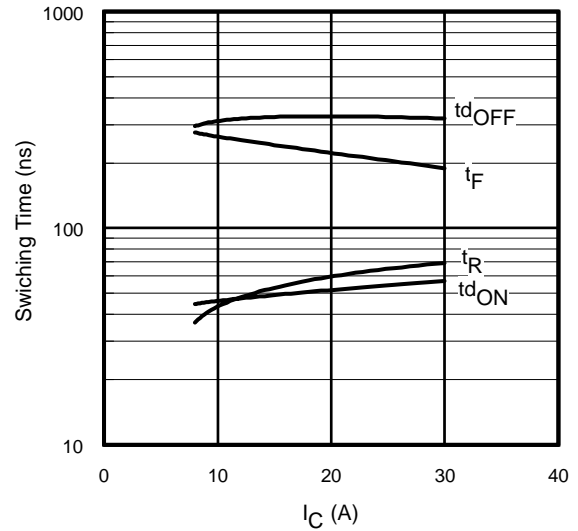

Fig. 10 - Typ. Switching Time vs. I_C

$T_J = 125^\circ C$; $L=400\mu H$; $V_{CE}= 600V$, $R_G= 22\Omega$; $V_{GE}= 15V$

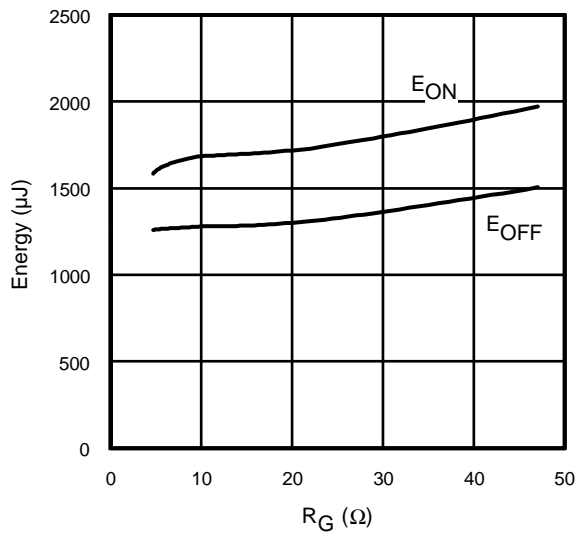

Fig. 11 - Typ. Energy Loss vs. R_G

$T_J = 125^\circ C$; $L=400\mu H$; $V_{CE}= 600V$, $I_{CE}= 15A$; $V_{GE}= 15V$

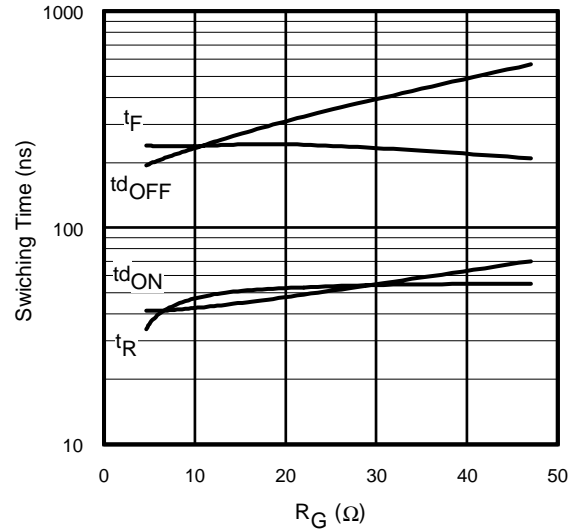

Fig. 12 - Typ. Switching Time vs. R_G

$T_J = 125^\circ C$; $L=400\mu H$; $V_{CE}= 600V$, $I_{CE}= 15A$; $V_{GE}= 15V$

Inverter

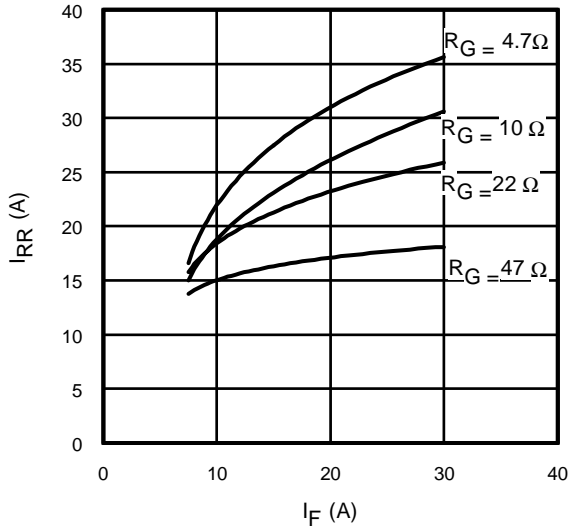

Fig. 13 - Typical Diode I_{RR} vs. I_F
 $T_J = 125^\circ\text{C}$

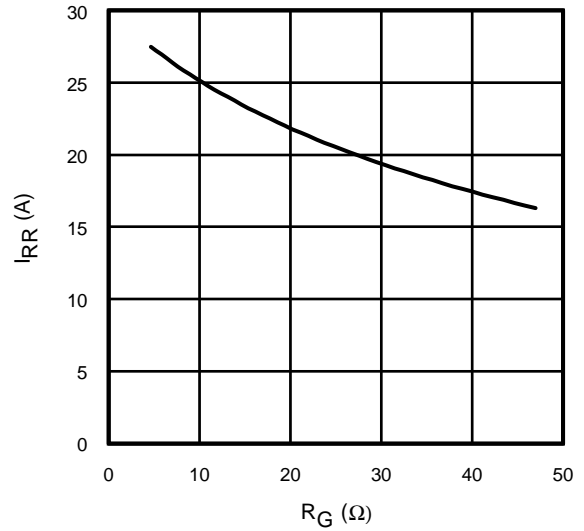

Fig. 14 - Typical Diode I_{RR} vs. R_G
 $T_J = 125^\circ\text{C}; I_F = 15\text{A}$

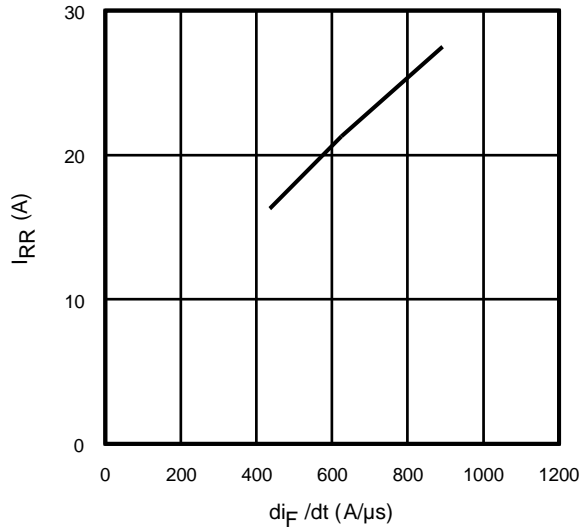

Fig. 15- Typical Diode I_{RR} vs. di_F/dt
 $V_{CC} = 600\text{V}; V_{GE} = 15\text{V}; I_{CE} = 15\text{A}; T_J = 125^\circ\text{C}$

Thermistor

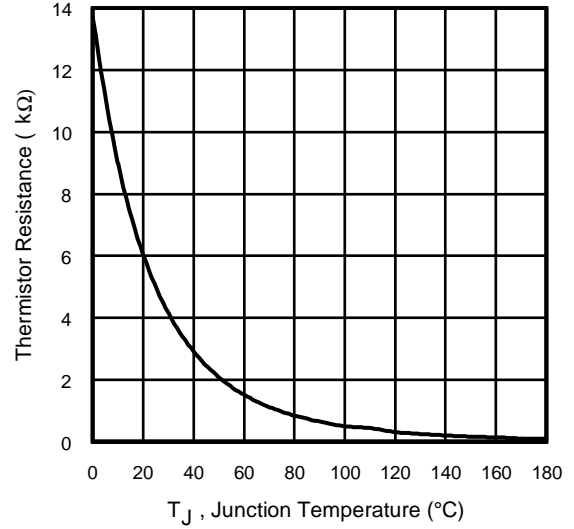

Fig. 16 - Thermistor Resistance vs. Temperature

Input Rectifier

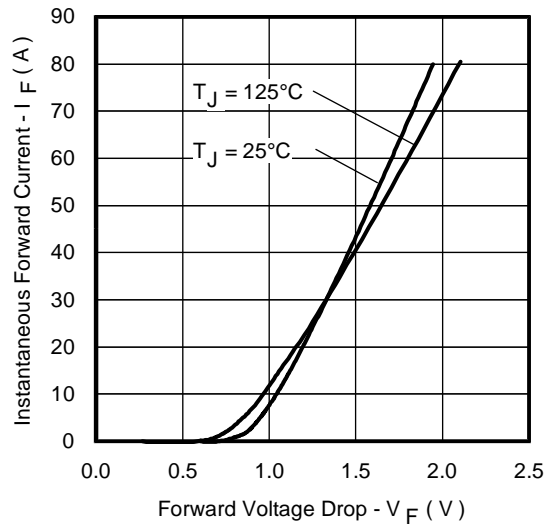

Fig. 17- Typ. Diode Forward Characteristics
 $t_p = 80\mu\text{s}$

Inverter

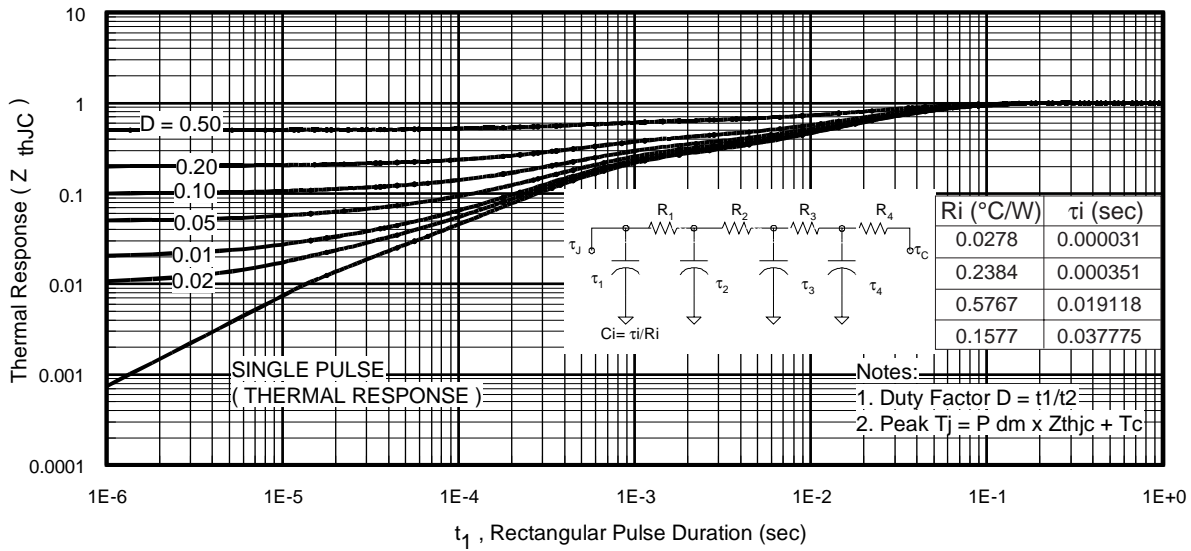

Fig 18. Maximum Transient Thermal Impedance, Junction-to-Case (Inverter IGBT)

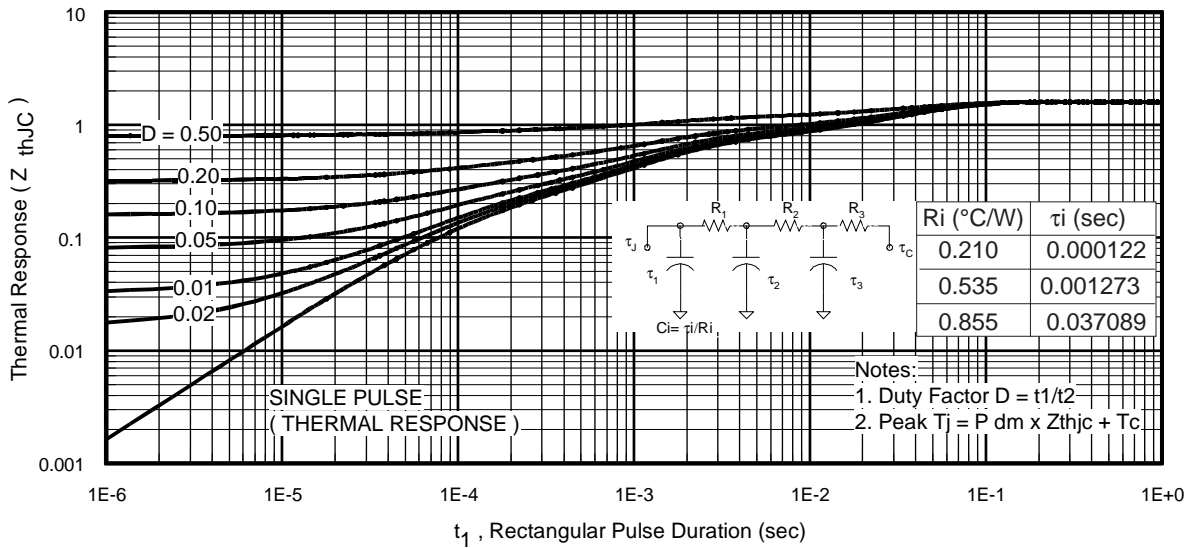

Fig 19. Maximum Transient Thermal Impedance, Junction-to-Case (Inverter FRED)

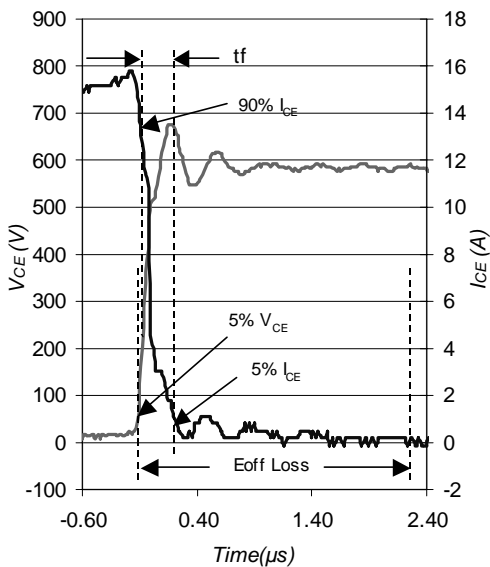

Fig. WF1- Typ. Turn-off Loss Waveform @ $T_j = 125^\circ\text{C}$ using Fig. CT.4

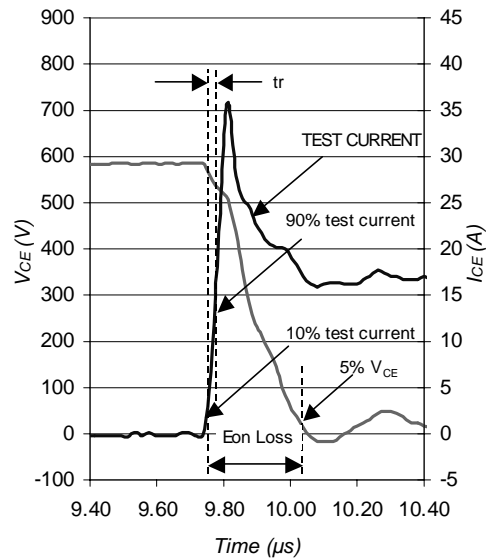

Fig. WF2- Typ. Turn-on Loss Waveform @ $T_j = 125^\circ\text{C}$ using Fig. CT.4

Brake

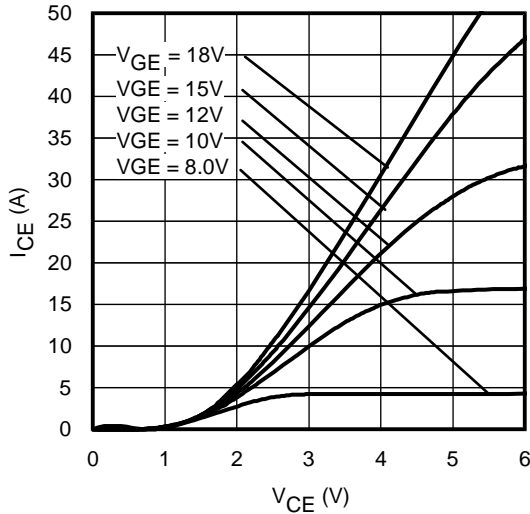

Fig. 20 - Typ. IGBT Output Characteristics
 $T_J = 25^\circ\text{C}$; $t_p = 80\mu\text{s}$

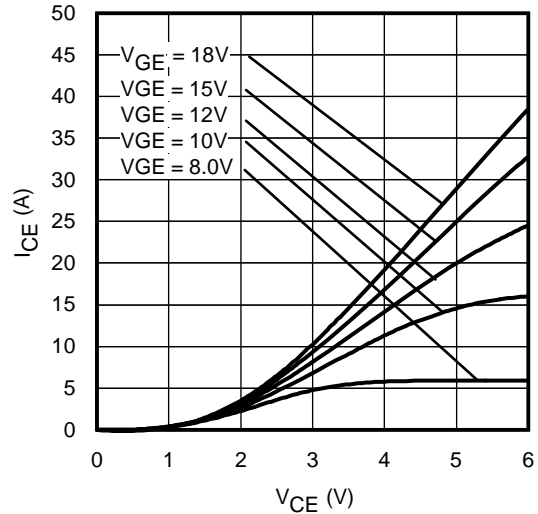

Fig. 21 - Typ. IGBT Output Characteristics
 $T_J = 125^\circ\text{C}$; $t_p = 80\mu\text{s}$

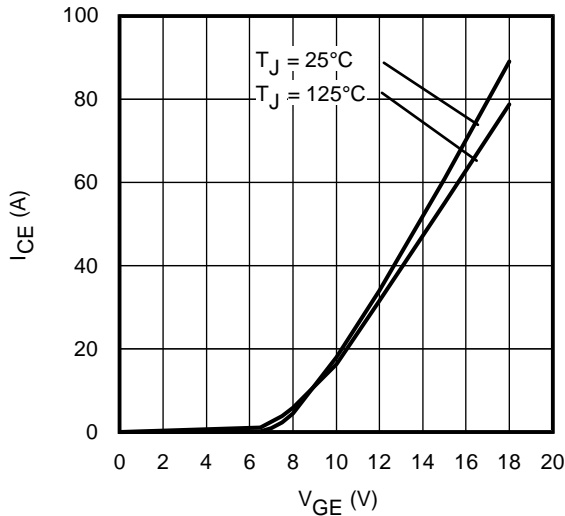

Fig. 22 - Typ. Transfer Characteristics
 $V_{CE} = 50\text{V}$; $t_p = 10\mu\text{s}$

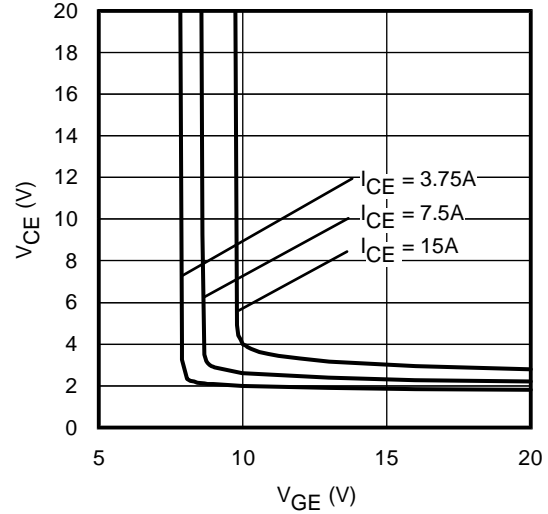

Fig. 23 - Typical V_{CE} vs. V_{GE}
 $T_J = 25^\circ\text{C}$

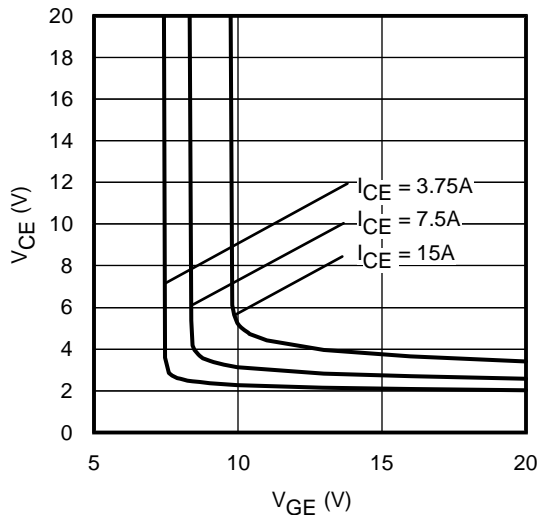

Fig. 24 - Typical V_{CE} vs. V_{GE}
 $T_J = 125^\circ\text{C}$

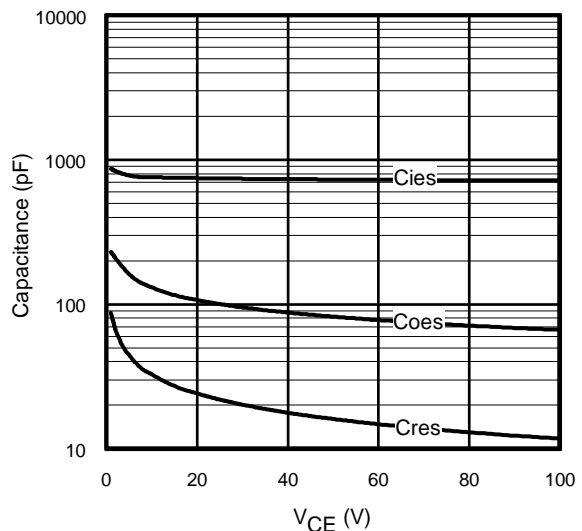

Fig. 25 - Typ. Capacitance vs. V_{CE}
 $V_{GE} = 0\text{V}$; $f = 1\text{MHz}$

Brake

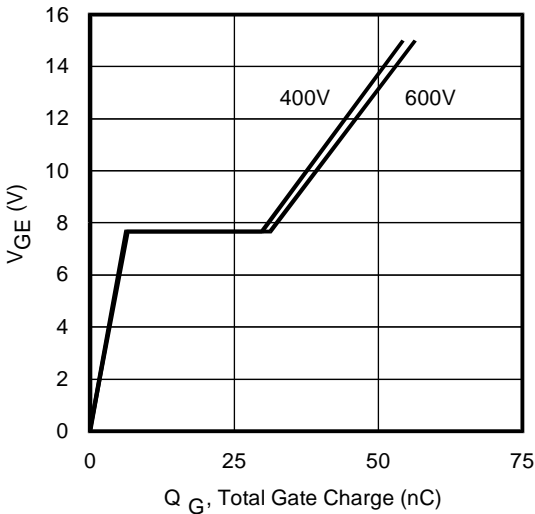

Fig. 26 - Typical Gate Charge vs. V_{GE}
 $I_{CE} = 7.5A$; $L = 1.0mH$

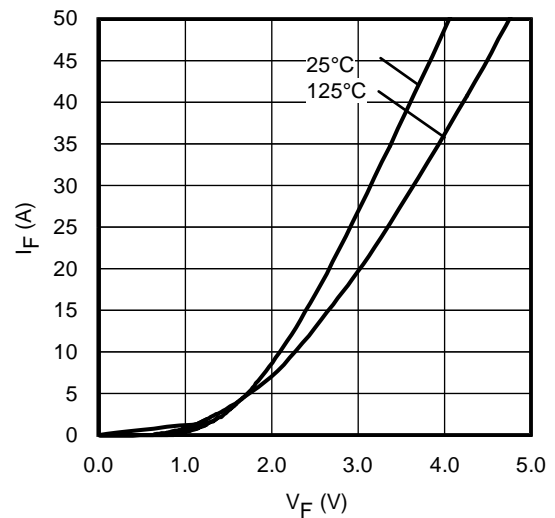

Fig. 27 - Typ. Diode Forward Characteristics
 $t_p = 80\mu s$

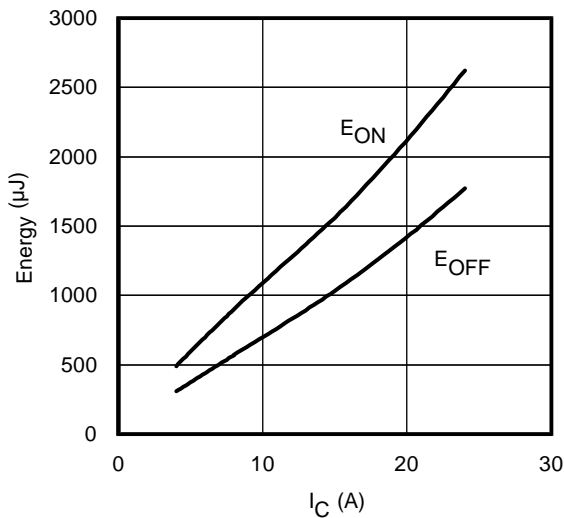

Fig. 28 - Typ. Energy Loss vs. I_C
 $T_J = 125^\circ C$; $L=400\mu H$; $V_{CE}= 600V$, $R_G= 47\Omega$; $V_{GE}= 15V$

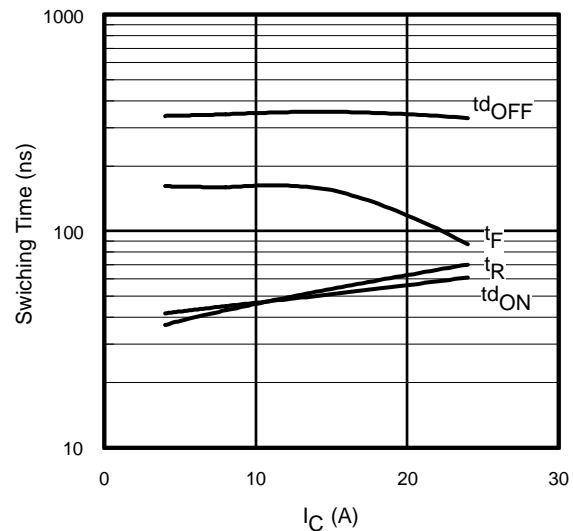

Fig. 29 - Typ. Switching Time vs. I_C
 $T_J = 125^\circ C$; $L=400\mu H$; $V_{CE}= 600V$, $R_G= 47\Omega$; $V_{GE}= 15V$

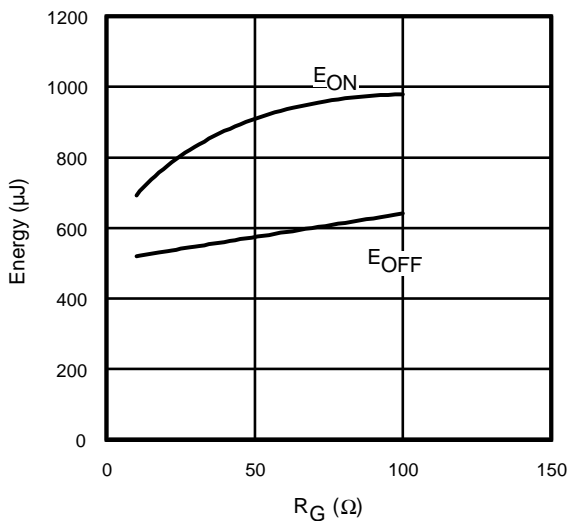

Fig. 30 - Typ. Energy Loss vs. R_G
 $T_J = 125^\circ C$; $L=400\mu H$; $V_{CE}= 600V$, $I_{CE}= 8.0A$; $V_{GE}= 15V$

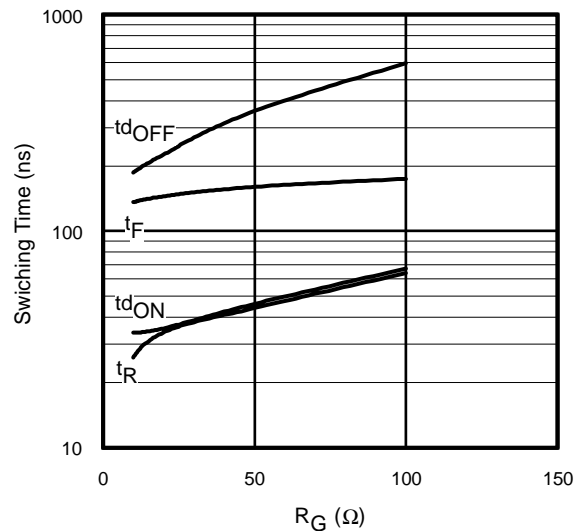

Fig. 31 - Typ. Switching Time vs. R_G
 $T_J = 125^\circ C$; $L=400\mu H$; $V_{CE}= 600V$, $I_{CE}= 8.0A$; $V_{GE}= 15V$

Brake

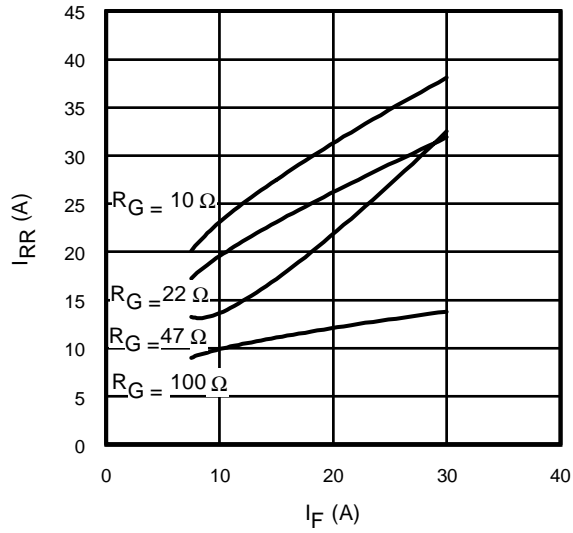

Fig. 32 - Typical Diode I_{RR} vs. I_F
 $T_J = 125^\circ\text{C}$

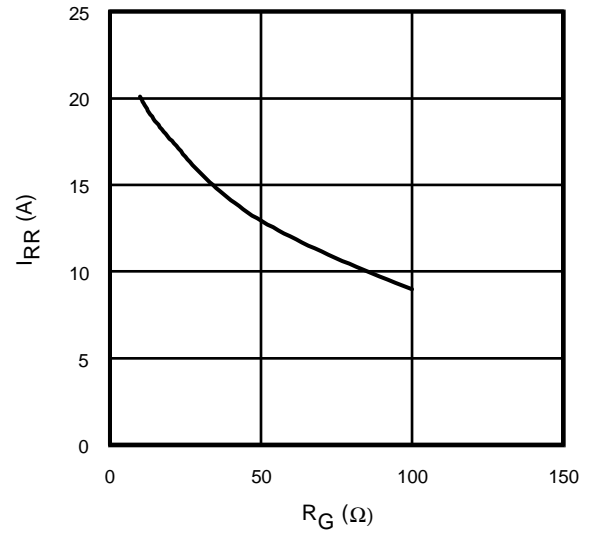

Fig. 33- Typical Diode I_{RR} vs. R_G
 $T_J = 125^\circ\text{C}$; $I_F = 7.5\text{A}$

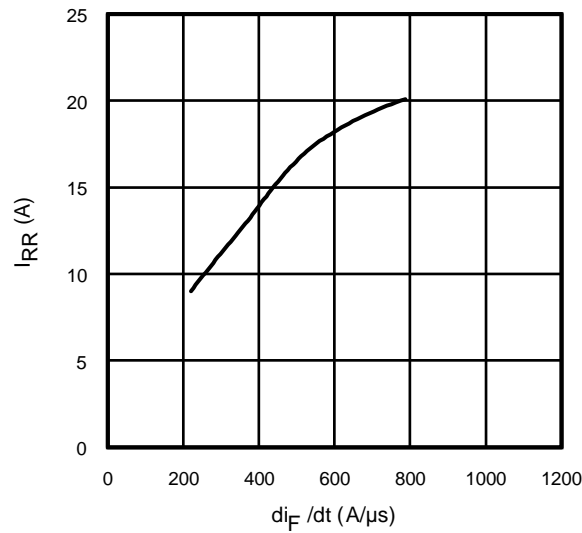

Fig. 34- Typical Diode I_{RR} vs. di_F/dt
 $V_{CC} = 600\text{V}$; $V_{GE} = 15\text{V}$; $I_{CE} = 7.5\text{A}$; $T_J = 125^\circ\text{C}$

Brake

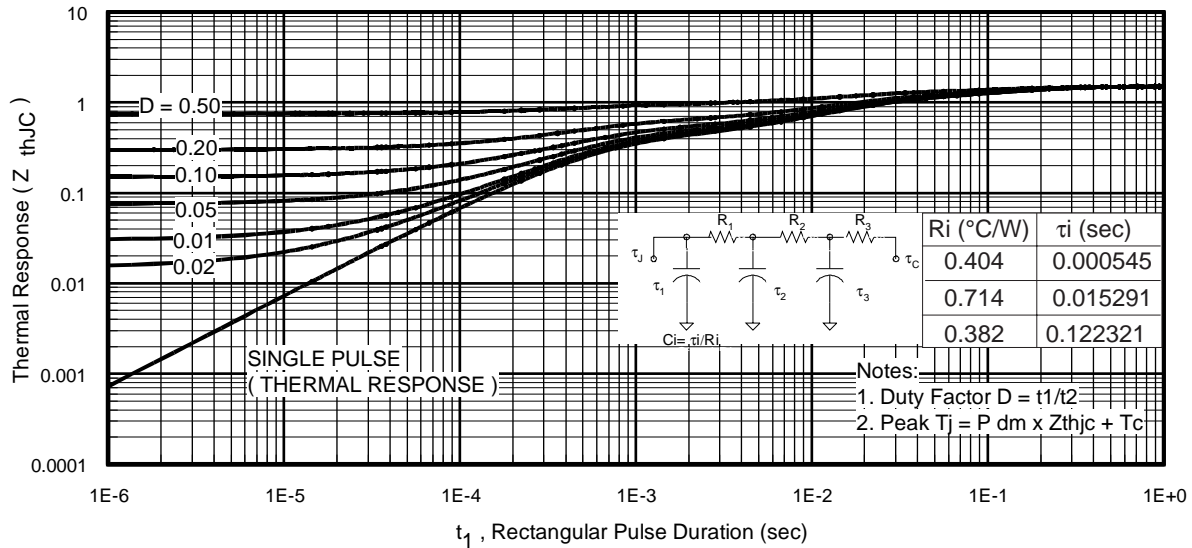

Fig 35. Maximum Transient Thermal Impedance, Junction-to-Case (Brake IGBT)

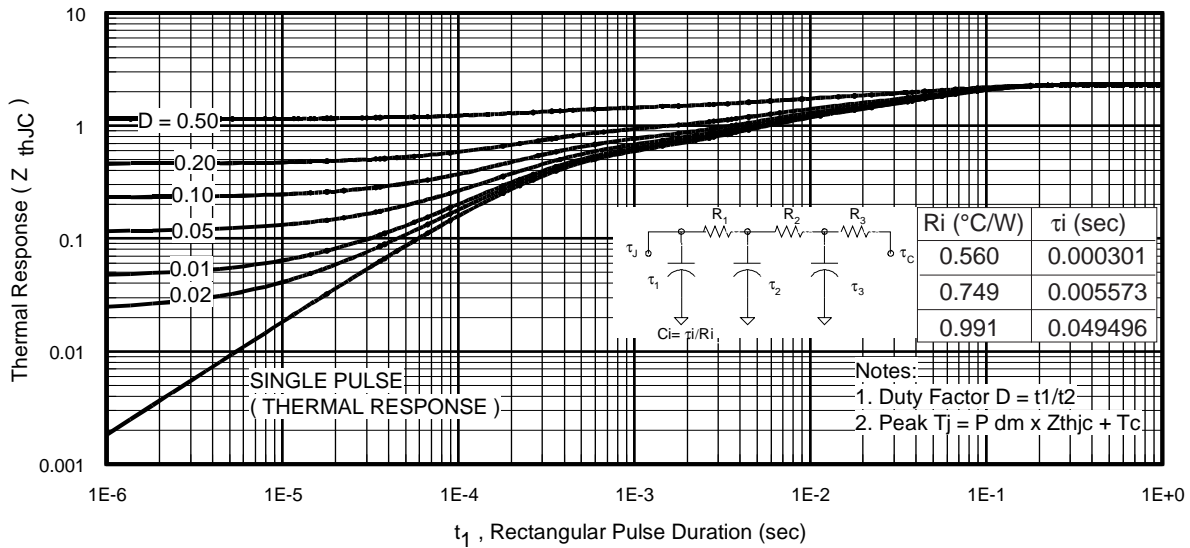

Fig 36. Maximum Transient Thermal Impedance, Junction-to-Case (Brake Diode)

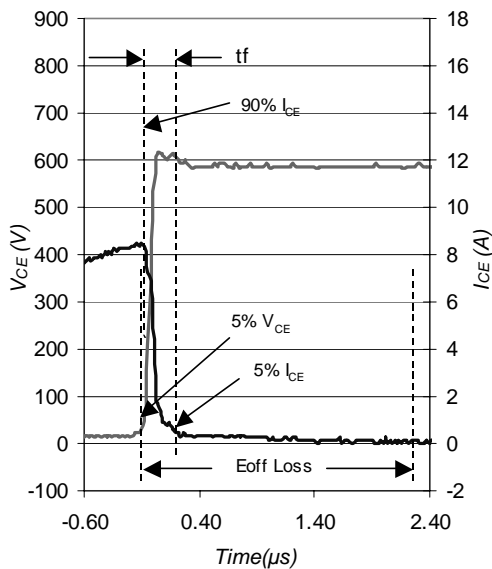

Fig. WF3- Typ. Turn-off Loss Waveform
@ $T_J = 125^\circ\text{C}$ using Fig. CT.4

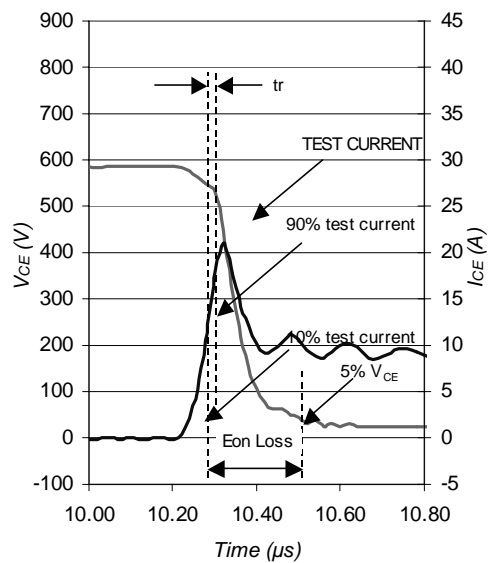

Fig. WF4- Typ. Turn-on Loss Waveform
@ $T_J = 125^\circ\text{C}$ using Fig. CT.4

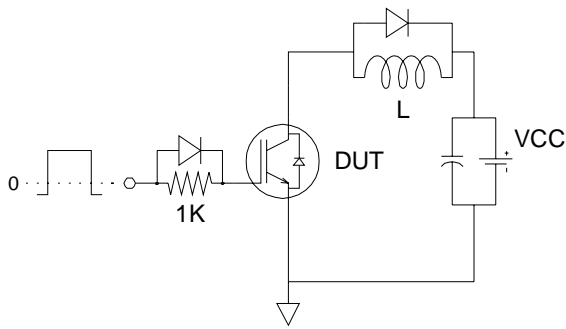

Fig.C.T.1 - Gate Charge Circuit (turn-off)

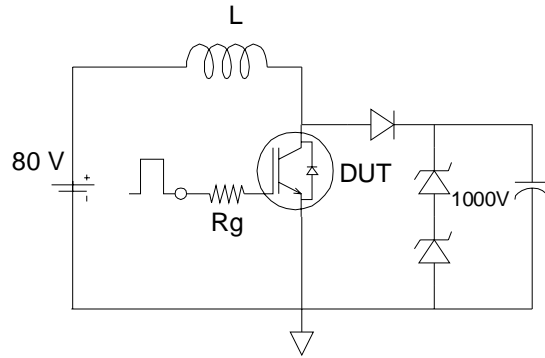

Fig.C.T.2 - RBSOA Circuit

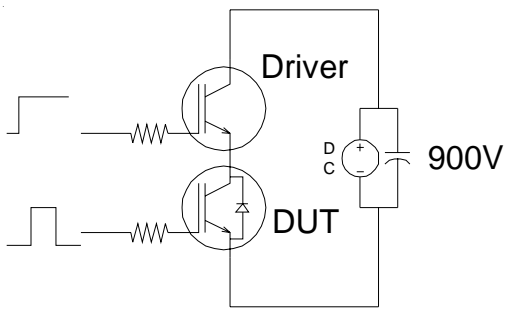

Fig.C.T.3 - S.C. SOA Circuit

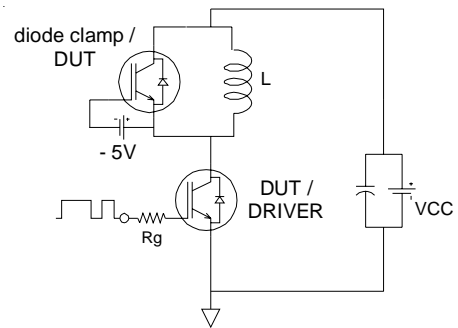

Fig.C.T.4 - Switching Loss Circuit

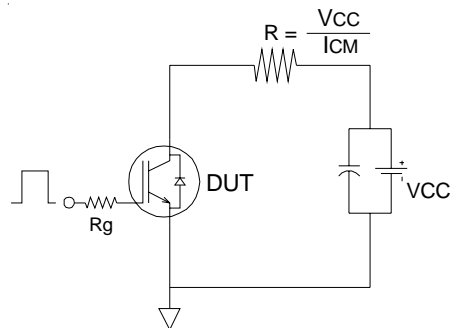
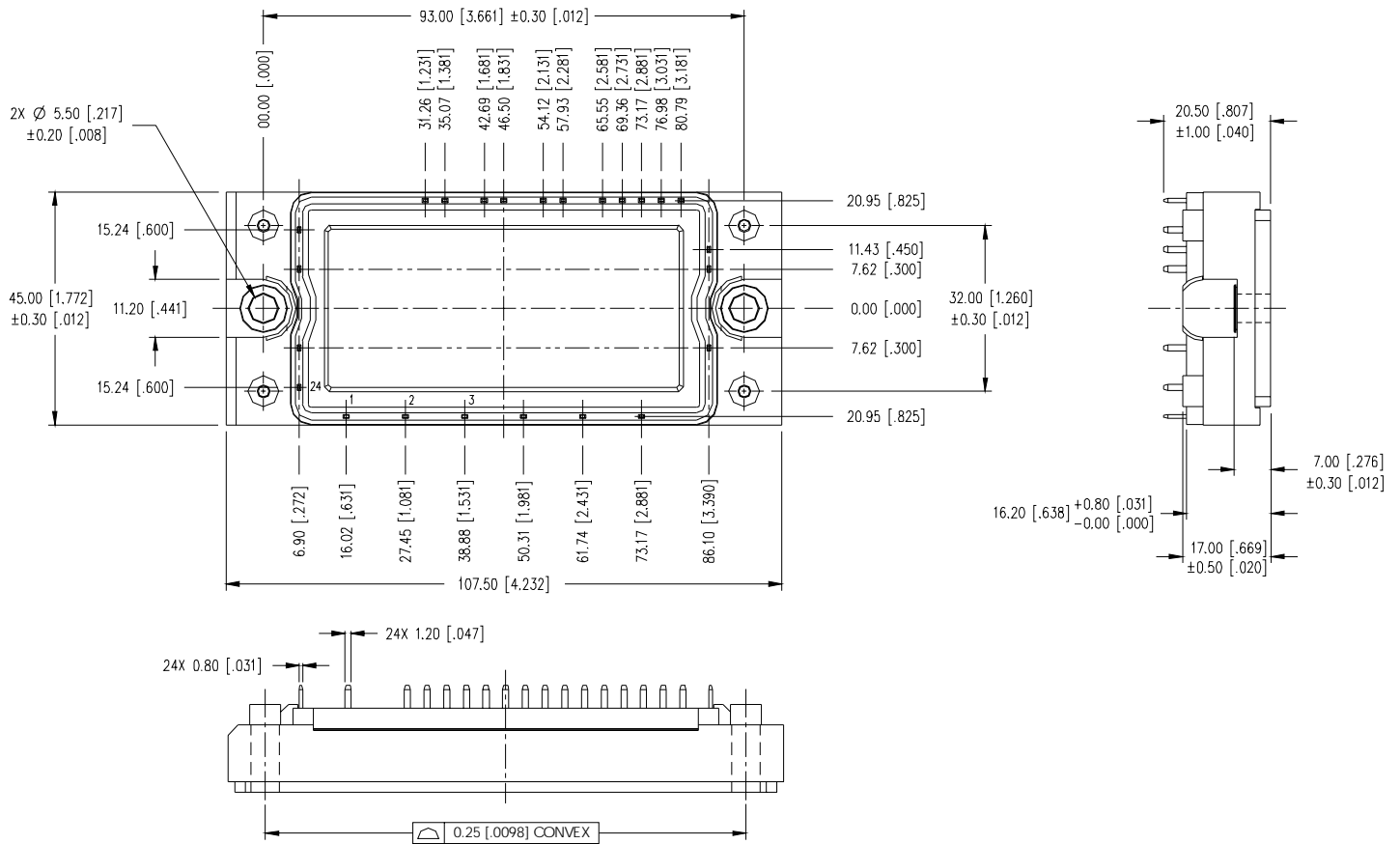

Fig.C.T.5 - Resistive Load Circuit

Econo2 PIM Package Outline

Dimensions are shown in millimeters (inches)



Econo2 PIM Part Marking Information

EXAMPLE: THIS IS A GB25RF120K
LOT CODE: 401438
ASSEMBLED ON WW 21, 2002

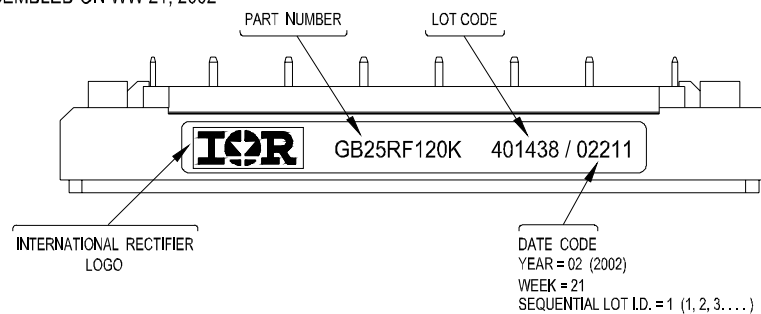

Data and specifications subject to change without notice.
This product has been designed and qualified for Industrial market.
Qualification Standards can be found on IR's Web site.