

MITSUBISHI Nch POWER MOSFET

# FY8AAJ-03A

HIGH-SPEED SWITCHING USE

## FY8AAJ-03A

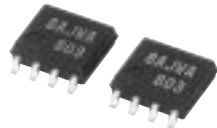

- 4V DRIVE
- V<sub>DSS</sub> ..... 30V
- r<sub>DS (ON)</sub> (MAX) ..... 23mΩ
- I<sub>D</sub> ..... 8A

## OUTLINE DRAWING

Dimensions in mm

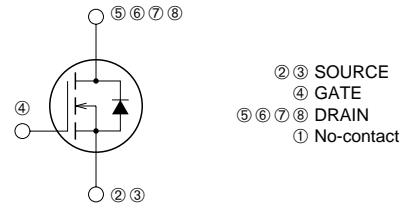
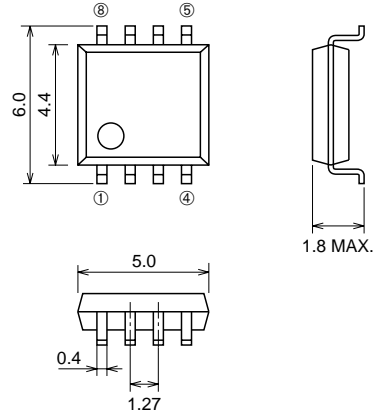

SOP-8

## APPLICATION

Motor control, Lamp control, Solenoid control  
DC-DC converter, etc.

## MAXIMUM RATINGS (T<sub>c</sub> = 25°C)

Symbol	Parameter	Conditions	Ratings	Unit
V <sub>DSS</sub>	Drain-source voltage	V <sub>GS</sub> = 0V	30	V
V <sub>GSS</sub>	Gate-source voltage	V <sub>DS</sub> = 0V	±20	V
I <sub>D</sub>	Drain current		8	A
I <sub>DM</sub>	Drain current (Pulsed)		56	A
I <sub>DA</sub>	Avalanche drain current (Pulsed)	L = 10μH	8	A
I <sub>S</sub>	Source current		2	A
I <sub>SM</sub>	Source current (Pulsed)		8	A
P <sub>D</sub>	Maximum power dissipation		1.8	W
T <sub>ch</sub>	Channel temperature		-55 ~ +150	°C
T <sub>stg</sub>	Storage temperature		-55 ~ +150	°C
—	Weight	Typical value	0.07	g

Sep.1998

**ELECTRICAL CHARACTERISTICS** (Tch = 25°C)

Symbol	Parameter	Test conditions	Limits			Unit
			Min.	Typ.	Max.	
V(BR)DSS	Drain-source breakdown voltage	Id = 1mA, VGS = 0V	30	—	—	V
IGSS	Gate-source leakage current	VGS = ±20V, VDS = 0V	—	—	±0.1	μA
IDSS	Drain-source leakage current	VDS = 30V, VGS = 0V	—	—	0.1	mA
VGS(th)	Gate-source threshold voltage	Id = 1mA, VDS = 10V	1.0	1.5	2.0	V
rDS(ON)	Drain-source on-state resistance	Id = 8A, VGS = 10V	—	17	23	mΩ
rDS(ON)	Drain-source on-state resistance	Id = 4A, VGS = 4V	—	26	40	mΩ
VDS(ON)	Drain-source on-state voltage	Id = 8A, VGS = 10V	—	144	184	mV
yfs	Forward transfer admittance	Id = 8A, VDS = 10V	—	13	—	S
Ciss	Input capacitance	VDS = 10V, VGS = 0V, f = 1MHz	—	1000	—	pF
Coss	Output capacitance		—	350	—	pF
Crss	Reverse transfer capacitance		—	160	—	pF
td(on)	Turn-on delay time	VDD = 15V, Id = 4A, VGS = 10V, RGEN = RGS = 50Ω	—	15	—	ns
tr	Rise time		—	25	—	ns
td(off)	Turn-off delay time		—	80	—	ns
tf	Fall time		—	55	—	ns
VSD	Source-drain voltage	IS = 2.0A, VGS = 0V	—	0.75	1.10	V
Rth(ch-a)	Thermal resistance	Channel to ambient	—	—	69.4	°C/W
trr	Reverse recovery time	IS = 2.0A, dis/dt = -50A/μs	—	35	—	ns

**PERFORMANCE CURVES**

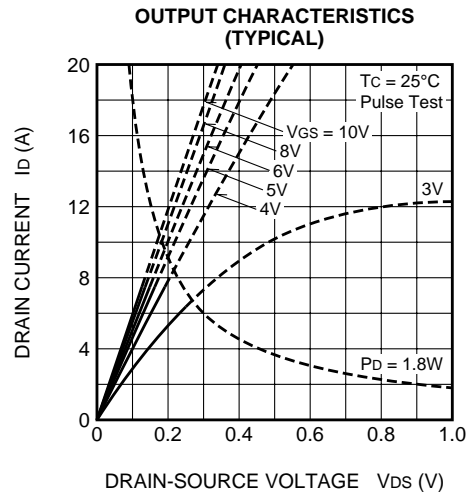
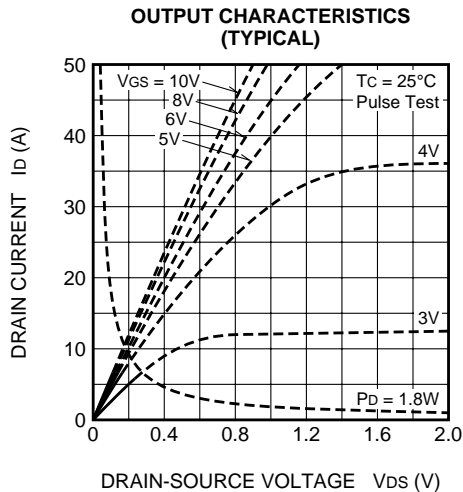
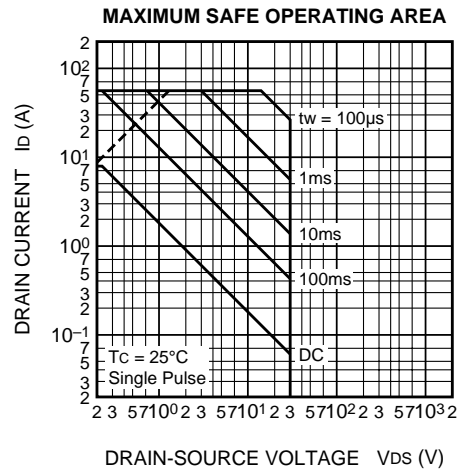
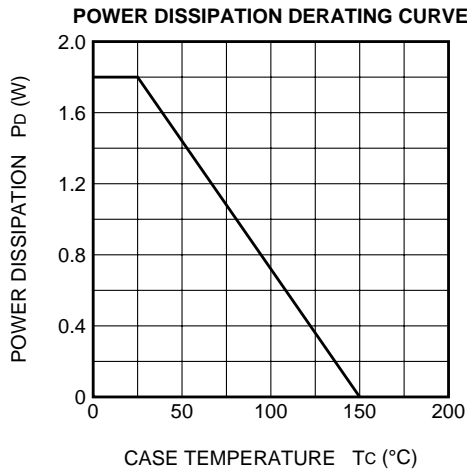

ON-STATE VOLTAGE VS. GATE-SOURCE VOLTAGE (TYPICAL)

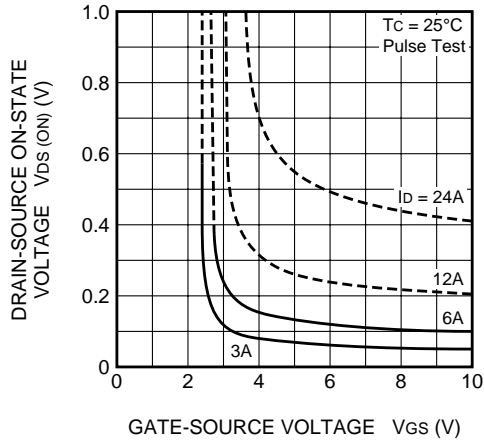

ON-STATE RESISTANCE VS. DRAIN CURRENT (TYPICAL)

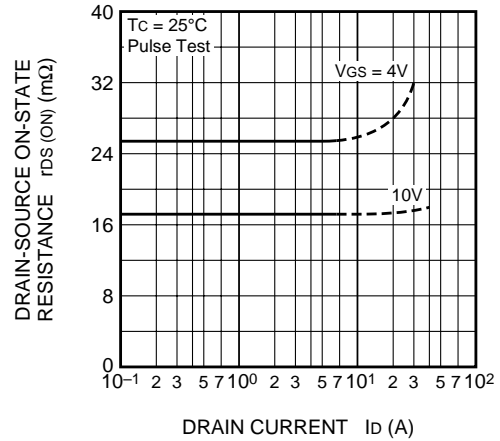

TRANSFER CHARACTERISTICS (TYPICAL)

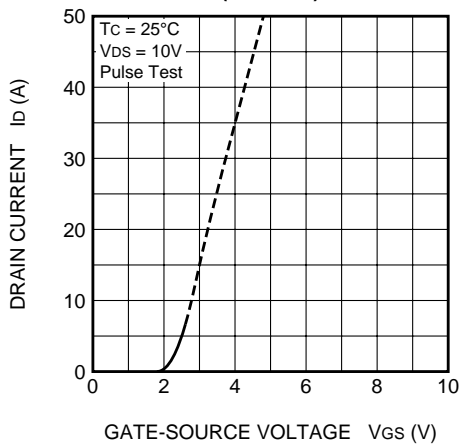

FORWARD TRANSFER ADMITTANCE VS. DRAIN CURRENT (TYPICAL)

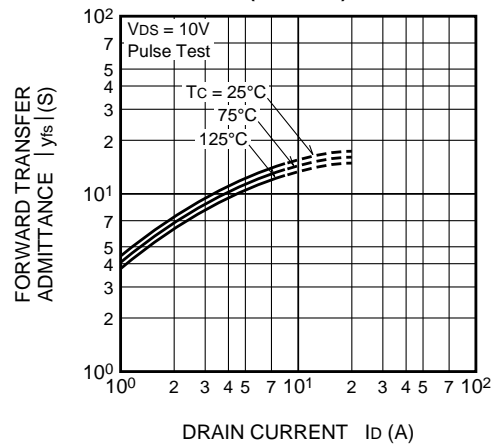

CAPACITANCE VS. DRAIN-SOURCE VOLTAGE (TYPICAL)

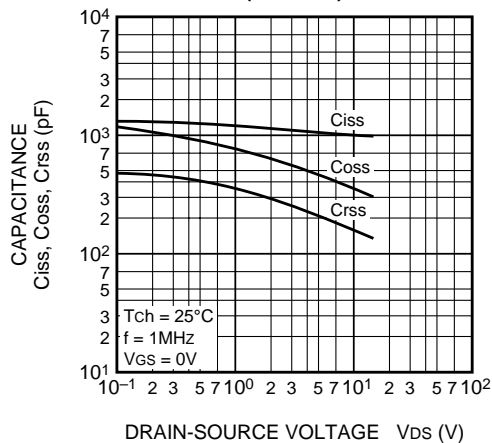

SWITCHING CHARACTERISTICS (TYPICAL)

