

MITSUBISHI Nch POWER MOSFET

FS30SM-5

HIGH-SPEED SWITCHING USE

FS30SM-5



- V_{DSS} 250V
- r_{DS (ON)} (MAX) 0.13Ω
- I_D 30A

OUTLINE DRAWING

Dimensions in mm

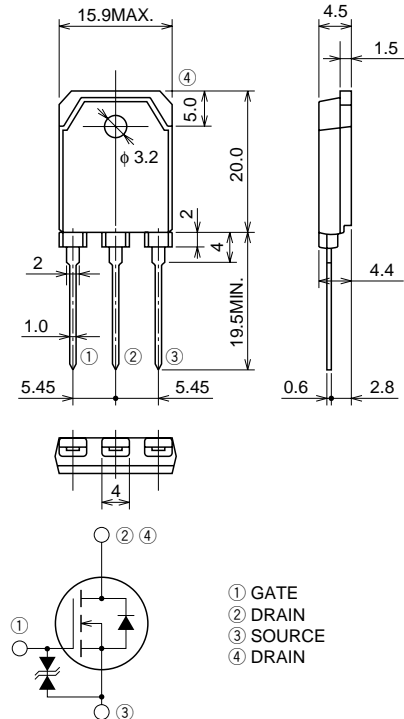

APPLICATION

SMPS, DC-DC Converter, battery charger, power supply of printer, copier, HDD, FDD, TV, VCR, personal computer etc.

MAXIMUM RATINGS (T_c = 25°C)

Symbol	Parameter	Conditions	Ratings	Unit
V _{DSS}	Drain-source voltage	V _{GS} = 0V	250	V
V _{GSS}	Gate-source voltage	V _{DS} = 0V	±30	V
I _D	Drain current		30	A
I _{DM}	Drain current (Pulsed)		90	A
P _D	Maximum power dissipation		250	W
T _{ch}	Channel temperature		-55 ~ +150	°C
T _{stg}	Storage temperature		-55 ~ +150	°C
—	Weight	Typical value	4.8	g

Feb.1999

ELECTRICAL CHARACTERISTICS (T_{ch} = 25°C)

Symbol	Parameter	Test conditions	Limits			Unit
			Min.	Typ.	Max.	
V (BR) DSS	Drain-source breakdown voltage	I _D = 1mA, V _{GS} = 0V	250	—	—	V
V (BR) GSS	Gate-source breakdown voltage	I _G = ±100μA, V _{DS} = 0V	±30	—	—	V
I _{GSS}	Gate-source leakage current	V _{GS} = ±25V, V _{DS} = 0V	—	—	±10	μA
I _{DSS}	Drain-source leakage current	V _{DS} = 250V, V _{GS} = 0V	—	—	1	mA
V _{GS} (th)	Gate-source threshold voltage	I _D = 1mA, V _{DS} = 10V	2	3	4	V
r _{DS} (ON)	Drain-source on-state resistance	I _D = 15A, V _{GS} = 10V	—	0.10	0.13	Ω
V _{DS} (ON)	Drain-source on-state voltage	I _D = 15A, V _{GS} = 10V	—	1.5	1.95	V
y _{fs}	Forward transfer admittance	I _D = 15A, V _{DS} = 10V	10.0	15.0	—	S
C _{iss}	Input capacitance	V _{DS} = 25V, V _{GS} = 0V, f = 1MHz	—	2100	—	pF
C _{oss}	Output capacitance		—	420	—	pF
C _{rss}	Reverse transfer capacitance		—	90	—	pF
t _d (on)	Turn-on delay time		—	35	—	ns
t _r	Rise time	V _{DD} = 150V, I _D = 15A, V _{GS} = 10V, R _{GEN} = R _{GS} = 50Ω	—	85	—	ns
t _d (off)	Turn-off delay time		—	240	—	ns
t _f	Fall time		—	100	—	ns
V _{SD}	Source-drain voltage		I _S = 15A, V _{GS} = 0V	—	1.5	2.0
R _{th} (ch-c)	Thermal resistance	Channel to case	—	—	0.50	°C/W

PERFORMANCE CURVES

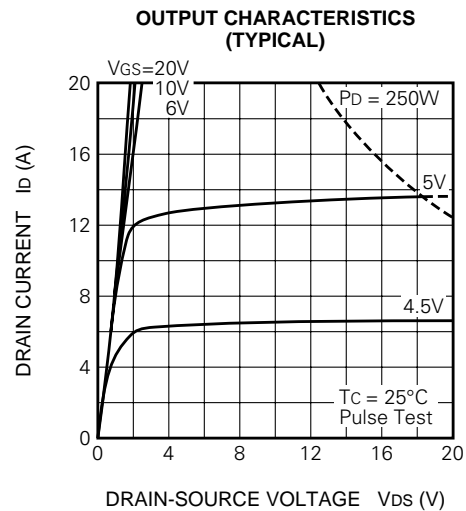
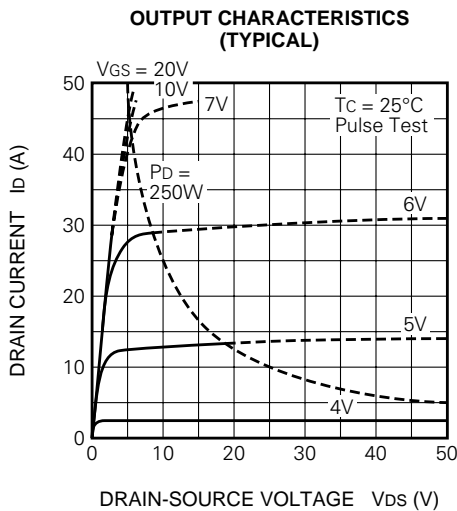
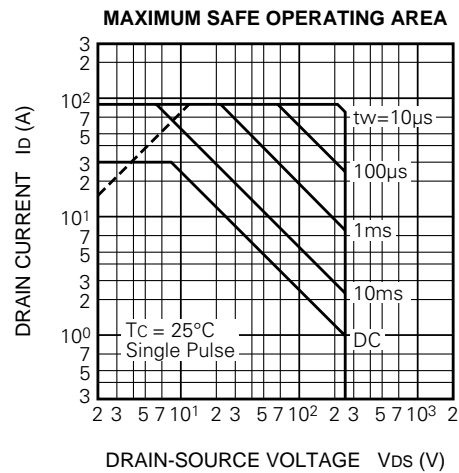
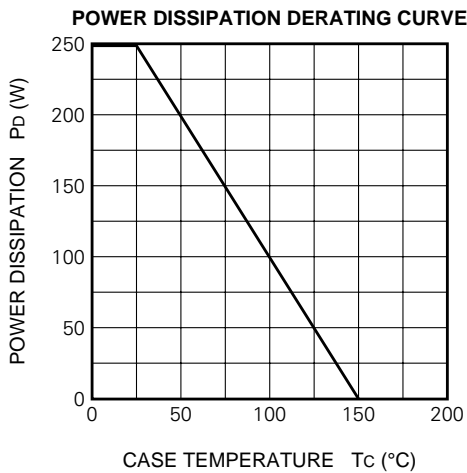

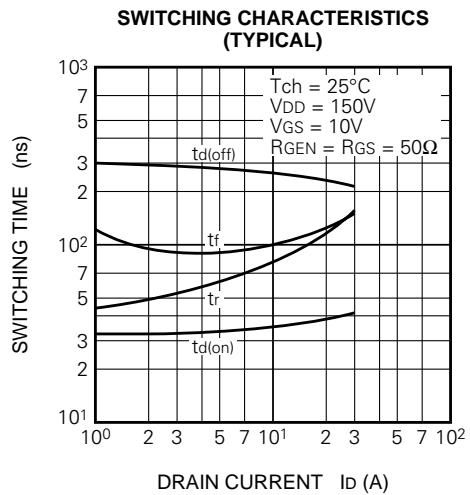
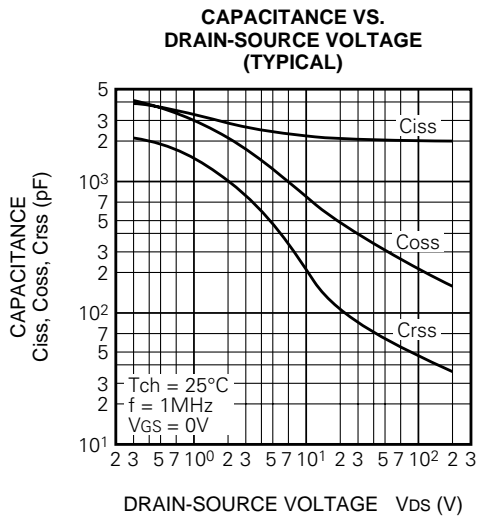
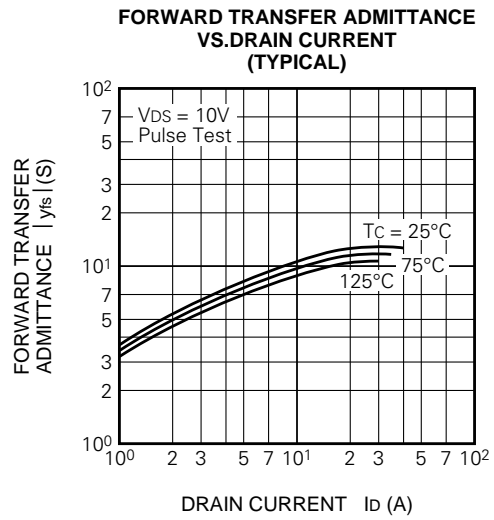
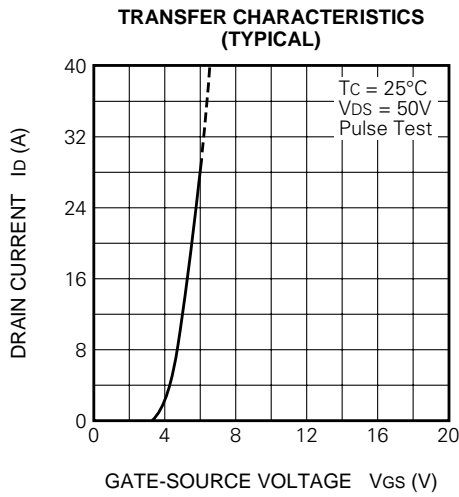
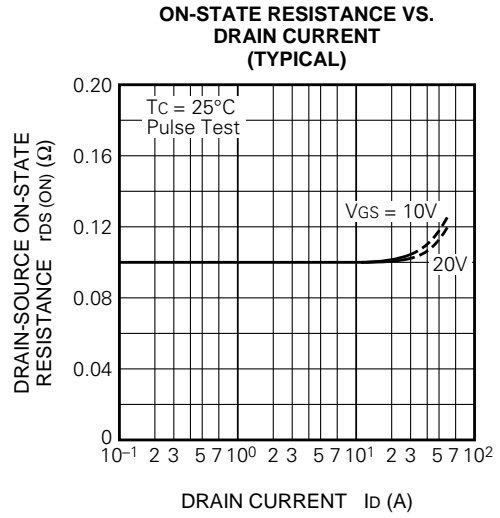
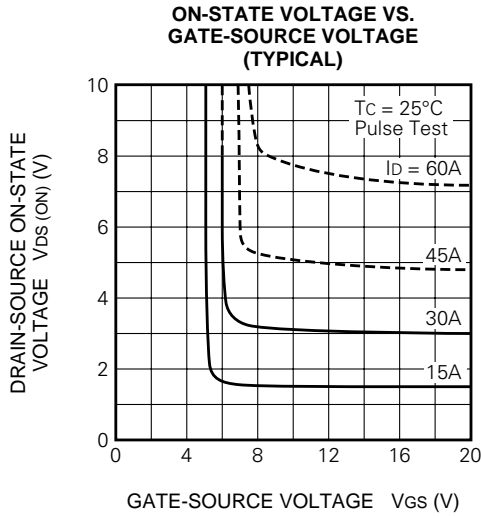

GATE-SOURCE VOLTAGE VS. GATE CHARGE (TYPICAL)

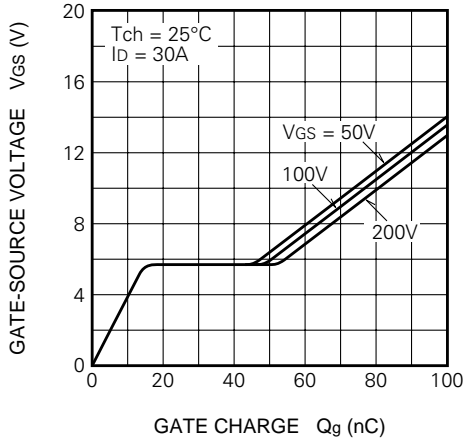

SOURCE-DRAIN DIODE FORWARD CHARACTERISTICS (TYPICAL)

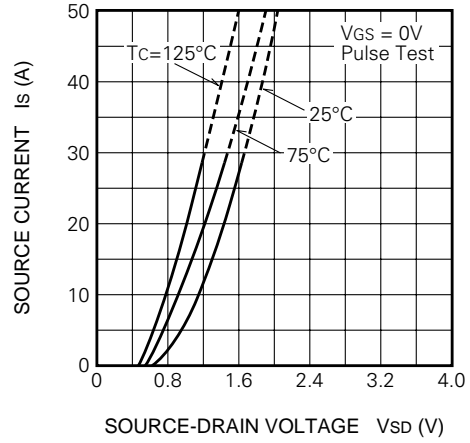

ON-STATE RESISTANCE VS. CHANNEL TEMPERATURE (TYPICAL)

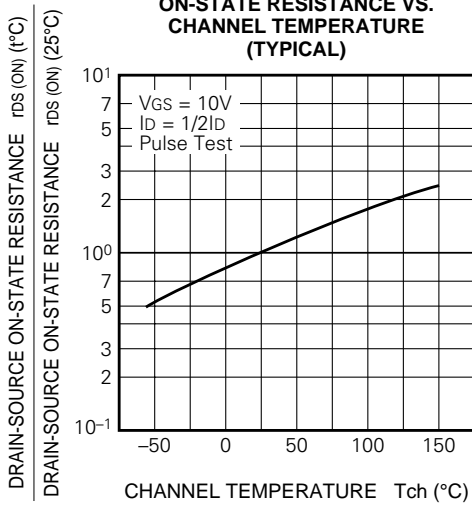

THRESHOLD VOLTAGE VS. CHANNEL TEMPERATURE (TYPICAL)

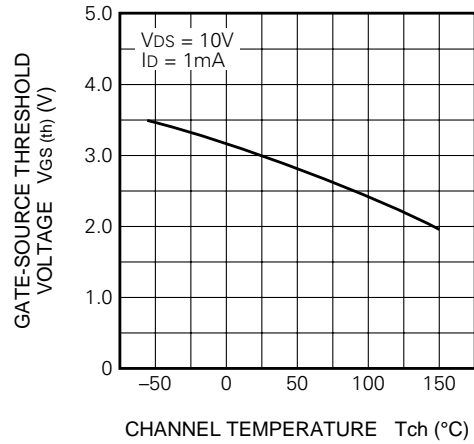

BREAKDOWN VOLTAGE VS. CHANNEL TEMPERATURE (TYPICAL)

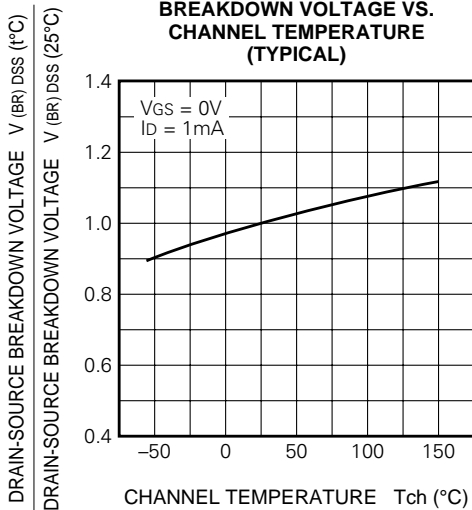

TRANSIENT THERMAL IMPEDANCE CHARACTERISTICS

