

# NPT<sup>3</sup> IGBT phaseleg

in ISOPLUS i4-PAC™

$I_{C25} = 50 \text{ A}$   
 $V_{CES} = 1200 \text{ V}$   
 $V_{CE(sat) \text{ typ.}} = 2.0 \text{ V}$

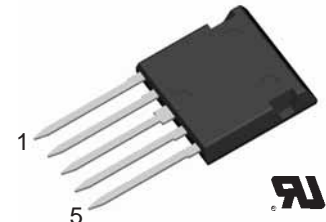
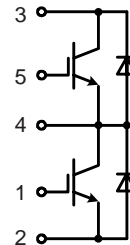

### IGBTs

Symbol	Conditions	Maximum Ratings	
$V_{CES}$	$T_{VJ} = 25^{\circ}\text{C to } 150^{\circ}\text{C}$	1200	V
$V_{GES}$		$\pm 20$	V
$I_{C25}$	$T_C = 25^{\circ}\text{C}$	50	A
$I_{C90}$	$T_C = 90^{\circ}\text{C}$	32	A
$I_{CM}$ $V_{CEK}$	$V_{GE} = \pm 15 \text{ V}; R_G = 39 \Omega; T_{VJ} = 125^{\circ}\text{C}$ RBSOA, Clamped inductive load; $L = 100 \mu\text{H}$	50	A
		$V_{CES}$	
$t_{SC}$ (SCSOA)	$V_{CE} = 900\text{V}; V_{GE} = \pm 15 \text{ V}; R_G = 39 \Omega; T_{VJ} = 125^{\circ}\text{C}$ non-repetitive	10	$\mu\text{s}$
$P_{tot}$	$T_C = 25^{\circ}\text{C}$	200	W

### Features

- NPT<sup>3</sup> IGBT
  - low saturation voltage
  - positive temperature coefficient for easy paralleling
  - fast switching
  - short tail current for optimized performance in resonant circuits
- HiPerFRED™ diode
  - fast reverse recovery
  - low operating forward voltage
  - low leakage current
- ISOPLUS i4-PAC™ package
  - isolated back surface
  - enlarged creepage towards heatsink
  - application friendly pinout
  - low inductive current path
  - high reliability
  - industry standard outline
  - UL registered, E 72873

Symbol	Conditions	Characteristic Values ( $T_{VJ} = 25^{\circ}\text{C}$ , unless otherwise specified)		
		min.	typ.	max.
$V_{CE(sat)}$	$I_C = 30 \text{ A}; V_{GE} = 15 \text{ V}; T_{VJ} = 25^{\circ}\text{C}$ $T_{VJ} = 125^{\circ}\text{C}$	2.0 2.3	2.6	V V
$V_{GE(th)}$	$I_C = 1 \text{ mA}; V_{GE} = V_{CE}$	4.5	6.5	V
$I_{CES}$	$V_{CE} = V_{CES}; V_{GE} = 0 \text{ V}; T_{VJ} = 25^{\circ}\text{C}$ $T_{VJ} = 125^{\circ}\text{C}$	0.4	0.4	mA mA
$I_{GES}$	$V_{CE} = 0 \text{ V}; V_{GE} = \pm 20 \text{ V}$		200	nA
$t_{d(on)}$ $t_r$ $t_{d(off)}$ $t_f$ $E_{on}$ $E_{off}$	Inductive load, $T_{VJ} = 125^{\circ}\text{C}$ $V_{CE} = 600 \text{ V}; I_C = 30 \text{ A}$ $V_{GE} = \pm 15 \text{ V}; R_G = 39 \Omega$	85		ns
		50		ns
		440		ns
		50		ns
		4.6		mJ
		2.2		mJ
$C_{ies}$	$V_{CE} = 25 \text{ V}; V_{GE} = 0 \text{ V}; f = 1 \text{ MHz}$	2		nF
$Q_{Gon}$	$V_{CE} = 600 \text{ V}; V_{GE} = 15 \text{ V}; I_C = 30 \text{ A}$	250		nC
$R_{thJC}$ $R_{thJH}$	with heatsink compound	1.2	0.6	KW KW

### Applications

- single phaseleg
  - buck-boost chopper
- H bridge
  - power supplies
  - induction heating
  - four quadrant DC drives
  - controlled rectifier
- three phase bridge
  - AC drives
  - controlled rectifier

**Diodes**

Symbol	Conditions	Maximum Ratings	
$I_{F25}$	$T_C = 25^\circ\text{C}$	48	A
$I_{F90}$	$T_C = 90^\circ\text{C}$	25	A

Symbol	Conditions	Characteristic Values		
		min.	typ.	max.
$V_F$	$I_F = 30\text{ A}; T_{VJ} = 25^\circ\text{C}$ $T_{VJ} = 125^\circ\text{C}$	2.4	2.8	V
		1.8		V
$I_{RM}$ $t_{rr}$	$I_F = 30\text{ A}; di_f/dt = -1100\text{ A}/\mu\text{s}; T_{VJ} = 125^\circ\text{C}$	51		A
		180		ns
$E_{rec(off)}$	$V_R = 600\text{ V}; V_{GE} = 0\text{ V}$	1.8		mJ
$R_{thJC}$ $R_{thJS}$	(per diode)	1.6	1.3	K/W K/W

**Component**

Symbol	Conditions	Maximum Ratings	
$T_{VJ}$		-55...+150	$^\circ\text{C}$
$T_{stg}$		-55...+125	$^\circ\text{C}$
$V_{ISOL}$	$I_{ISOL} \leq 1\text{ mA}; 50/60\text{ Hz}$	2500	V~
$F_C$	mounting force with clip	20...120	N

Symbol	Conditions	Characteristic Values		
		min.	typ.	max.
$d_S, d_A$	pin - pin	1.7		mm
$d_S, d_A$	pin - backside metal	5.5		mm
Weight		9		g

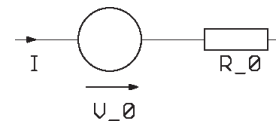
**Equivalent Circuits for Simulation**
**Conduction**

IGBT (typ. at  $V_{GE} = 15\text{ V}; T_J = 125^\circ\text{C}$ )  
 $V_0 = 0.95\text{ V}; R_0 = 45\text{ m}\Omega$

Diode (typ. at  $T_J = 125^\circ\text{C}$ )  
 $V_0 = 1.26\text{ V}; R_0 = 15\text{ m}\Omega$

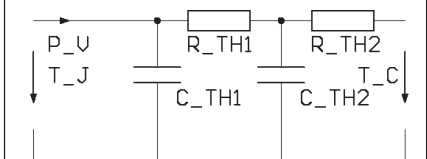
**Thermal Response**

**IGBT**

$C_{th1} = 0.067\text{ J/K}; R_{th1} = 0.108\text{ K/W}$   
 $C_{th2} = 0.175\text{ J/K}; R_{th2} = 0.491\text{ K/W}$

**Diode**

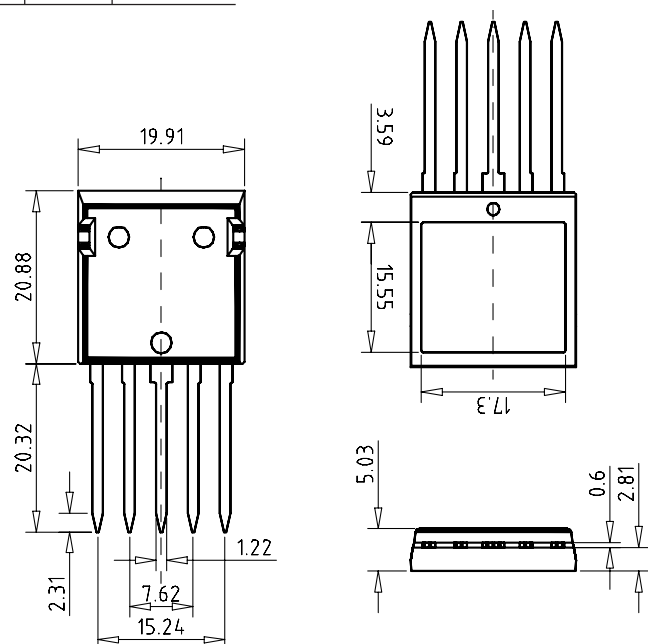
$C_{th1} = 0.039\text{ J/K}; R_{th1} = 0.337\text{ K/W}$   
 $C_{th2} = 0.090\text{ J/K}; R_{th2} = 0.963\text{ K/W}$

**Dimensions in mm (1 mm = 0.0394")**

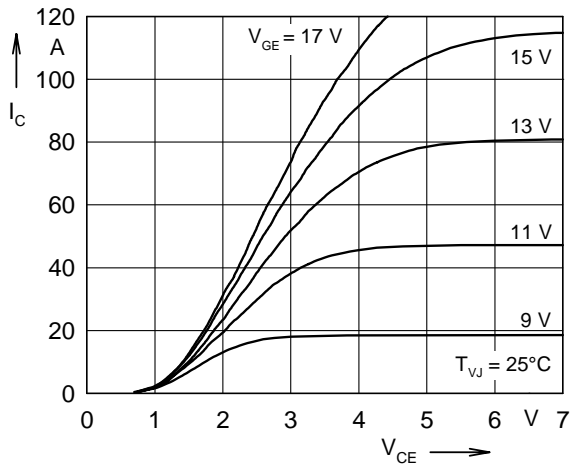

Fig. 1 Typ. output characteristics

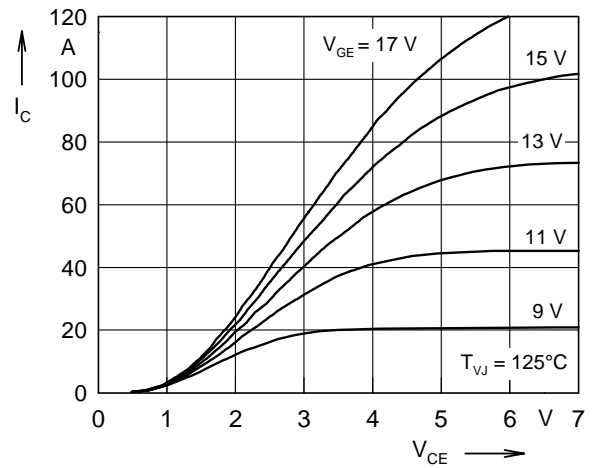

Fig. 2 Typ. output characteristics

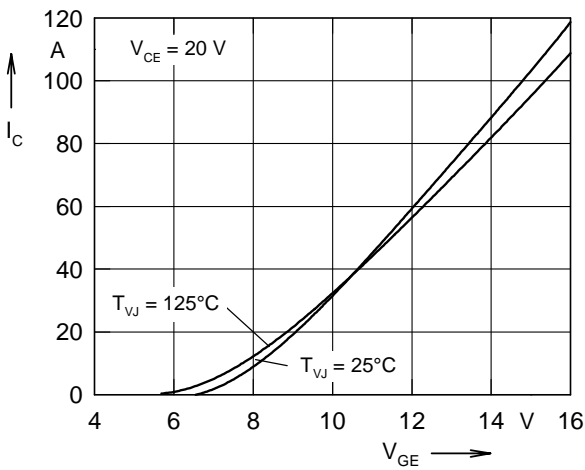

Fig. 3 Typ. transfer characteristics

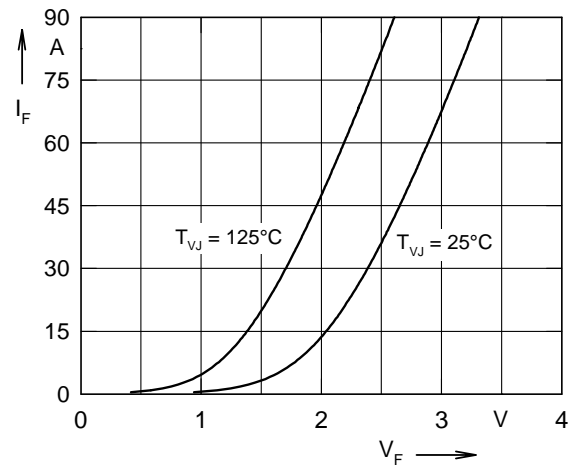

Fig. 4 Typ. forward characteristics of free wheeling diode

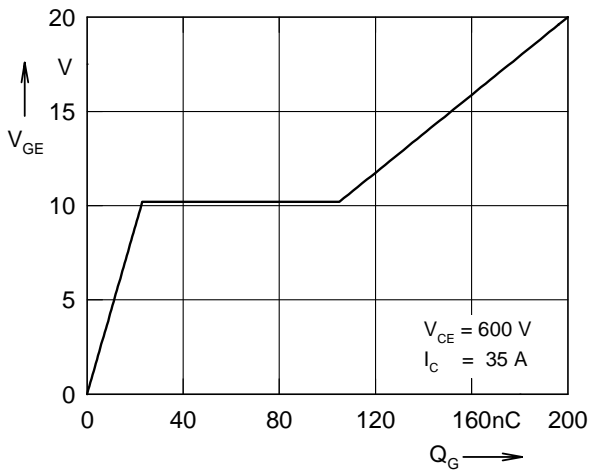

Fig. 5 Typ. turn on gate charge

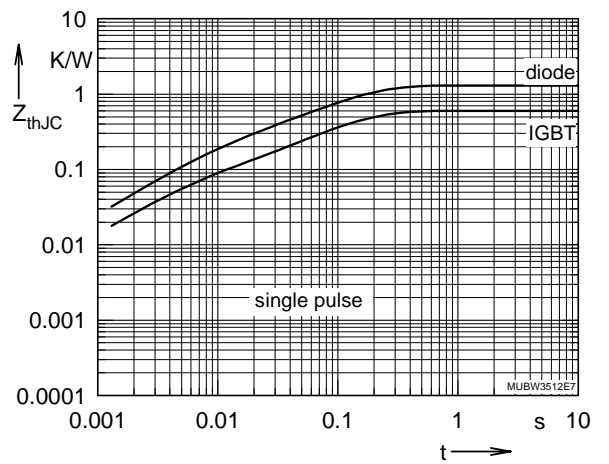

Fig. 6 Typ. transient thermal impedance

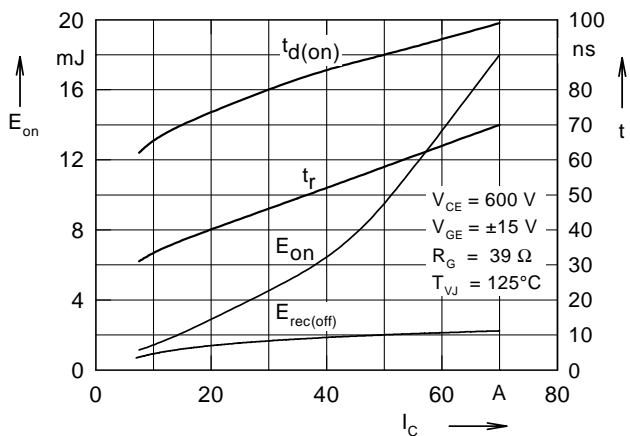

Fig. 7 Typ. turn on energy and switching times versus collector current

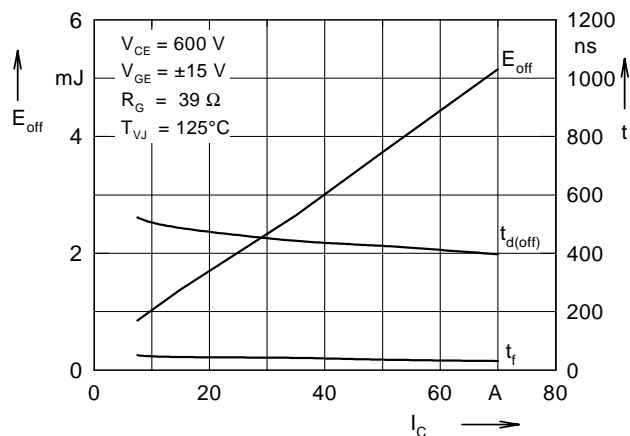

Fig. 8 Typ. turn off energy and switching times versus collector current

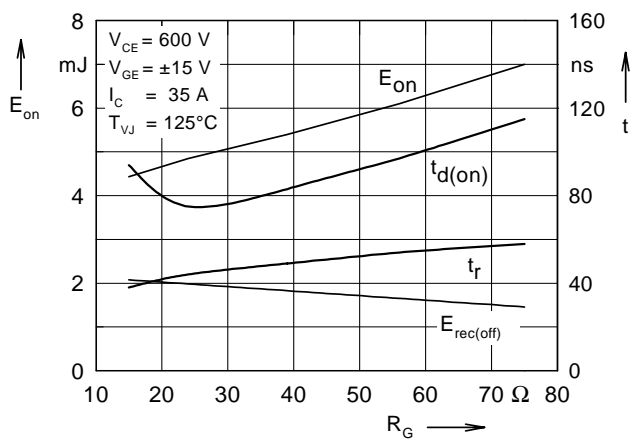

Fig. 9 Typ. turn on energy and switching times versus gate resistor

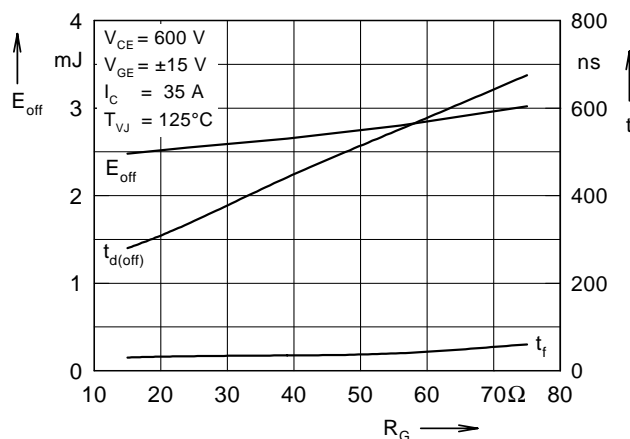

Fig.10 Typ. turn off energy and switching times versus gate resistor

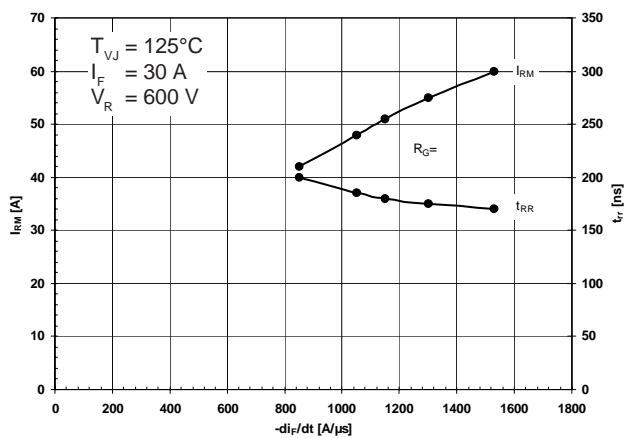

Fig. 11 Typ. turn off characteristics of free wheeling diode

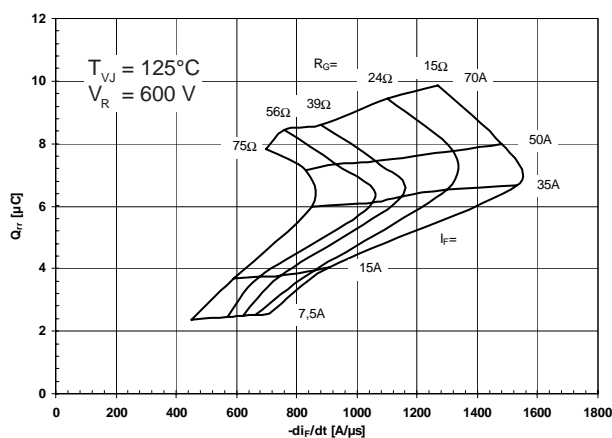

Fig. 12 Typ. turn off characteristics of free wheeling diode