

FDZ193P

P-Channel 1.7V PowerTrench® WL-CSP MOSFET

-20V, -1A, 90mΩ



Features

- Max $r_{DS(on)}$ = 90mΩ at $V_{GS} = -4.5V$, $I_D = -1A$
- Max $r_{DS(on)}$ = 130mΩ at $V_{GS} = -2.5V$, $I_D = -1A$
- Max $r_{DS(on)}$ = 300mΩ at $V_{GS} = -1.7V$, $I_D = -1A$
- Occupies only 1.5 mm² of PCB area Less than 50% of the area of 2 x 2 BGA
- Ultra-thin package: less than 0.65 mm height when mounted to PCB
- RoHS Compliant



General Description

Designed on Fairchild's advanced 1.7V PowerTrench® process with state of the art "low pitch" WLCSP packaging process, the FDZ193P minimizes both PCB space and $r_{DS(on)}$. This advanced WLCSP MOSFET embodies a breakthrough in packaging technology which enables the device to combine excellent thermal transfer characteristics, ultra-low profile packaging, low gate charge, and low $r_{DS(on)}$.

Application

- Battery management
- Load switch
- Battery protection

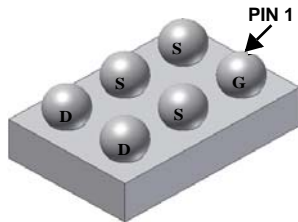

BOTTOM



TOP

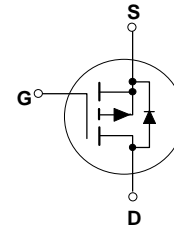

MOSFET Maximum Ratings $T_A = 25^\circ\text{C}$ unless otherwise noted

Symbol	Parameter	Rated	Units
V_{DS}	Drain to Source Voltage	-20	V
V_{GS}	Gate to Source Voltage	±12	V
I_D	Drain Current -Continuous	(Note 1a) -3	A
	-Pulsed	-15	
P_D	Power Dissipation	(Note 1a) 1.5	W
	Power Dissipation	(Note 1b) 0.9	
T_J, T_{STG}	Operating and Storage Junction Temperature Range	-55 to +150	°C

Thermal Characteristics

$R_{\theta JA}$	Thermal Resistance, Junction to Ambient	(Note 1a) 83	°C/W
$R_{\theta JA}$	Thermal Resistance, Junction to Ambient	(Note 1b) 140	

Package Marking and Ordering Information

Device Marking	Device	Package	Reel Size	Tape Width	Quantity
2	FDZ193P	WL-CSP	7"	8mm	5000 units

Electrical Characteristics $T_J = 25^\circ\text{C}$ unless otherwise noted

Symbol	Parameter	Test Conditions	Min	Typ	Max	Units
--------	-----------	-----------------	-----	-----	-----	-------

Off Characteristics

BV_{DSS}	Drain to Source Breakdown Voltage	$I_D = -250\mu\text{A}, V_{GS} = 0\text{V}$	-20			V
$\frac{\Delta BV_{DSS}}{\Delta T_J}$	Breakdown Voltage Temperature Coefficient	$I_D = -250\mu\text{A}$, referenced to 25°C		-11		mV/ $^\circ\text{C}$
I_{DSS}	Zero Gate Voltage Drain Current	$V_{DS} = -16\text{V}, V_{GS} = 0\text{V}$			-1	μA
I_{GSS}	Gate to Source Leakage Current	$V_{GS} = \pm 12\text{V}, V_{DS} = 0\text{V}$			± 100	nA

On Characteristics

$V_{GS(th)}$	Gate to Source Threshold Voltage	$V_{GS} = V_{DS}, I_D = -250\mu\text{A}$	-0.6	-0.9	-1.5	V
$\frac{\Delta V_{GS(th)}}{\Delta T_J}$	Gate to Source Threshold Voltage Temperature Coefficient	$I_D = -250\mu\text{A}$, referenced to 25°C		3		mV/ $^\circ\text{C}$
$r_{DS(on)}$	Drain to Source On Resistance	$V_{GS} = -4.5\text{V}, I_D = -1\text{A}$		66	90	m Ω
		$V_{GS} = -2.5\text{V}, I_D = -1\text{A}$		92	130	
		$V_{GS} = -1.7\text{V}, I_D = -1\text{A}$		195	300	
		$V_{GS} = -4.5\text{V}, I_D = -1\text{A}, T_J = 125^\circ\text{C}$		84	123	
$I_{D(on)}$	On to State Drain Current	$V_{GS} = -4.5\text{V}, V_{DS} = -5\text{V}$	-10			A
g_{FS}	Forward Transconductance	$V_{DS} = -5\text{V}, I_D = -1\text{A}$		5.6		S

Dynamic Characteristics

C_{iss}	Input Capacitance	$V_{DS} = -10\text{V}, V_{GS} = 0\text{V}, f = 1\text{MHz}$		660		pF
C_{oss}	Output Capacitance			150		pF
C_{rss}	Reverse Transfer Capacitance			90		pF
R_g	Gate Resistance	$f = 1\text{MHz}$		9.5		Ω

Switching Characteristics

$t_{d(on)}$	Turn-On Delay Time	$V_{DD} = -10\text{V}, I_D = -1\text{A}$ $V_{GS} = -4.5\text{V}, R_{GEN} = 6\Omega$		13	23	ns
t_r	Rise Time			10	20	ns
$t_{d(off)}$	Turn-Off Delay Time			28	45	ns
t_f	Fall Time			21	34	ns
$Q_{g(TOT)}$	Total Gate Charge at 10V		$V_{GS} = 0\text{V to } 10\text{V}$	$V_{DD} = -10\text{V}$ $I_D = -1\text{A}$	7	10
Q_{gs}	Gate to Source Gate Charge			1		nC
Q_{gd}	Gate to Drain "Miller" Charge			2		nC

Drain-Source Diode Characteristics

I_S	Maximum continuous Drain-Source Diode Forward Current			-1.1		A
V_{SD}	Source to Drain Diode Forward Voltage	$V_{GS} = 0\text{V}, I_S = -1.1\text{A}$ (Note 2)		-0.7	-1.2	V
t_{rr}	Reverse Recovery Time	$I_F = -1\text{A}, di/dt = 100\text{A}/\mu\text{s}$		19		ns
Q_{rr}	Reverse Recovery Charge			6		nC

Notes:

1: $R_{\theta JA}$ is determined with the device mounted on a 1in^2 pad 2 oz copper pad on a $1.5 \times 1.5\text{in.}$ board of FR-4 material. The thermal resistance from the junction to the circuit board side of the solder ball, $R_{\theta JB}$ is defined for reference. For $R_{\theta JC}$ the thermal reference point for the case is defined as the top surface of the copper chip carrier. $R_{\theta JC}$ and $R_{\theta JB}$ are guaranteed by design while $R_{\theta JA}$ is determined by the user's board design.

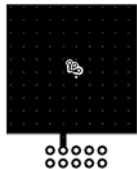

a. 83°C/W when mounted on a 1in^2 pad of 2 oz copper, $1.5'' \times 1.5'' \times 0.062''$ thick PCB



b. 140°C/W when mounted on a minimum pad of 2 oz copper

2: Pulse Test: Pulse Width $< 300\mu\text{s}$, Duty cycle $< 2.0\%$.

Typical Characteristics $T_J = 25^\circ\text{C}$ unless otherwise noted

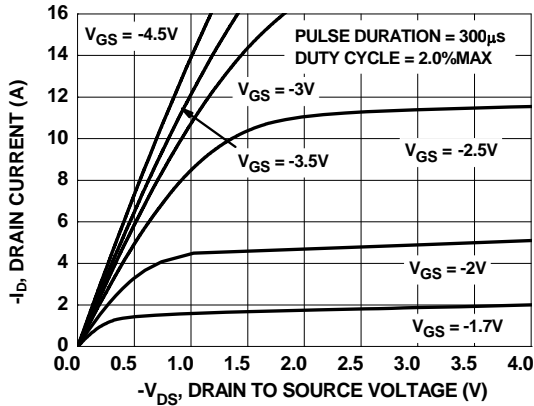

Figure 1. On Region Characteristics

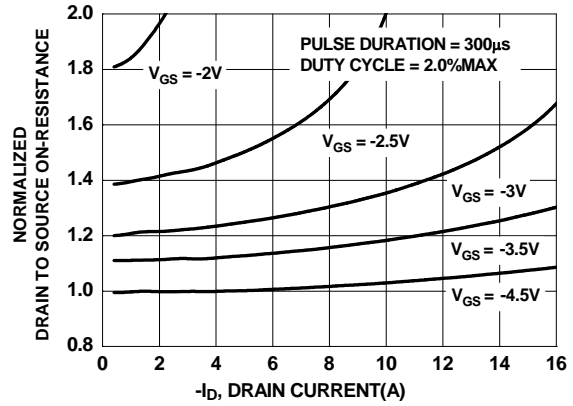

Figure 2. Normalized On-Resistance vs Drain Current and Gate Voltage

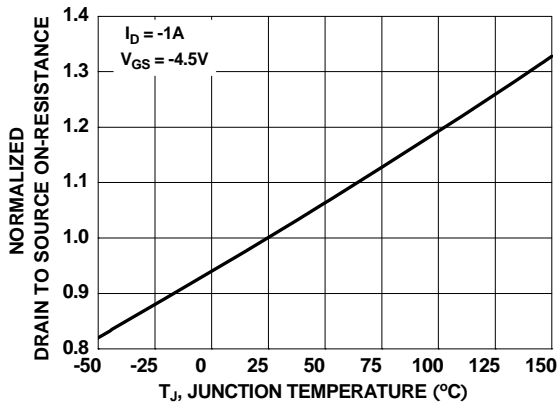

Figure 3. Normalized On Resistance vs Junction Temperature

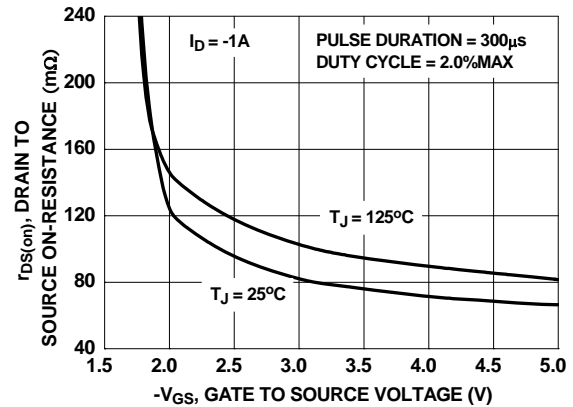

Figure 4. On-Resistance vs Gate to Source Voltage

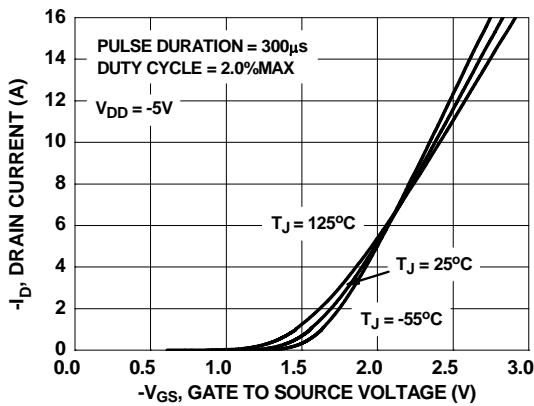

Figure 5. Transfer Characteristics

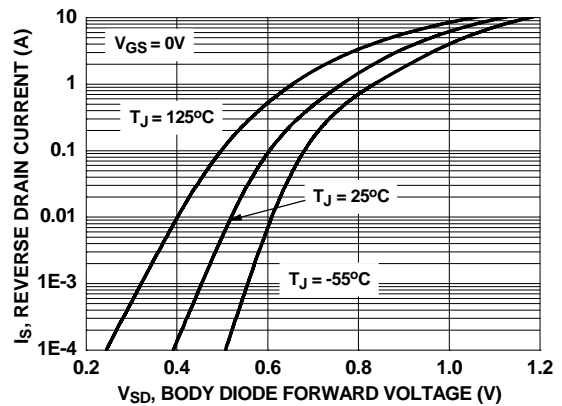

Figure 6. Source to Drain Diode Forward Voltage vs Source Current

Typical Characteristics $T_J = 25^\circ\text{C}$ unless otherwise noted

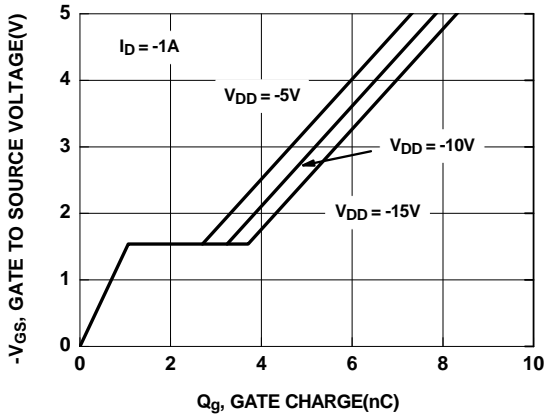

Figure 7. Gate Charge Characteristics

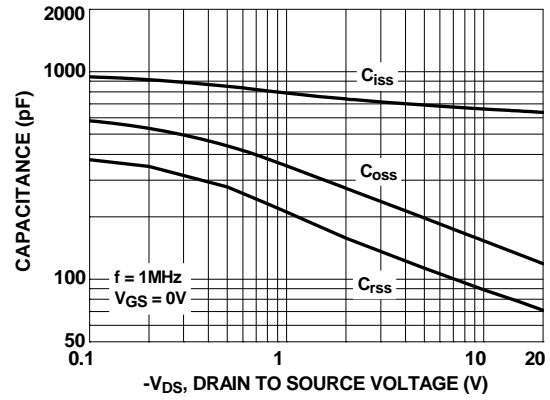

Figure 8. Capacitance vs Drain to Source Voltage

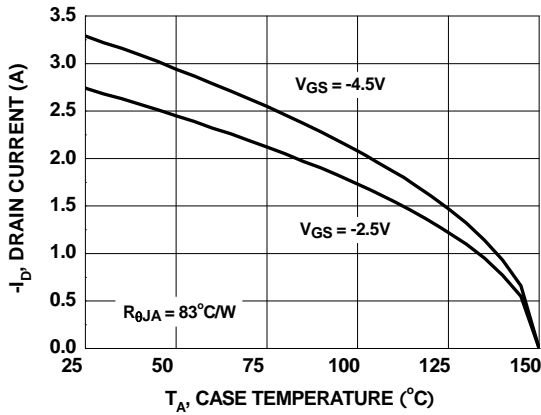

Figure 9. Maximum Continuous Drain Current vs Ambient Temperature

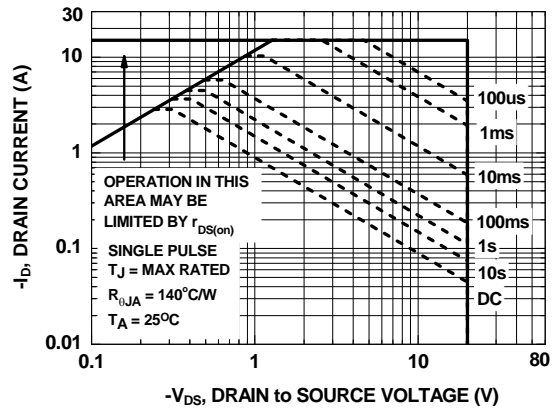

Figure 10. Forward Bias Safe Operating Area

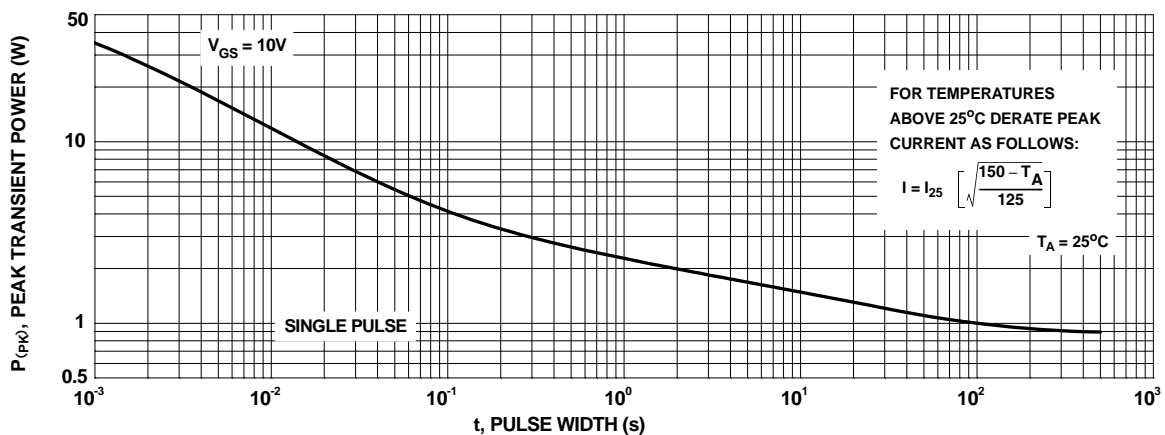

Figure 11. Single Pulse Maximum Power Dissipation

Typical Characteristics $T_J = 25^\circ\text{C}$ unless otherwise noted

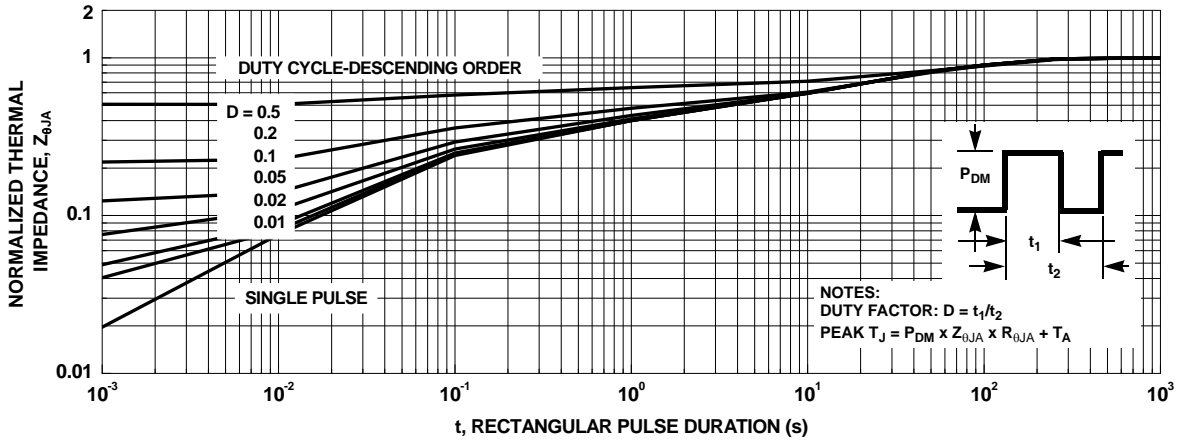
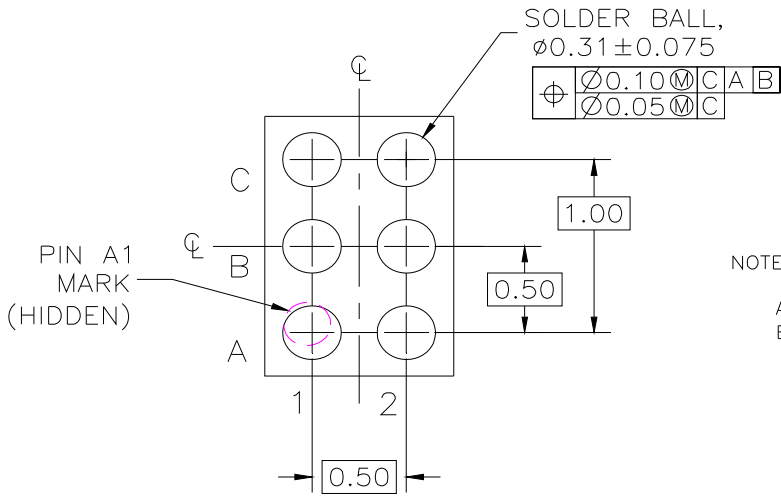
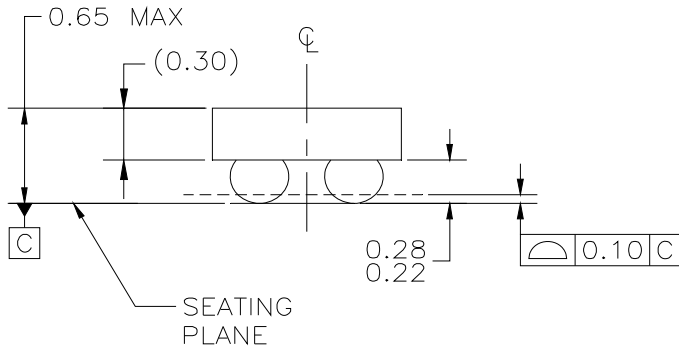
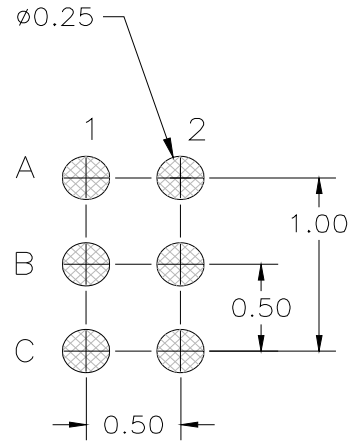
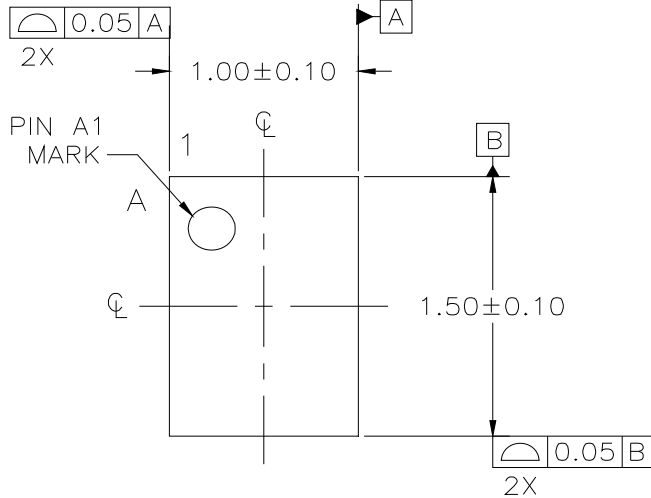

Figure 12. Transient Thermal Response Curve



NOTES: UNLESS OTHERWISE SPECIFIED

- A) ALL DIMENSIONS ARE IN MILLIMETERS.
- B) NO JEDEC REGISTRATION REFERENCE AS OF OCTOBER 2005.

UC006AAREVC

TRADEMARKS

The following are registered and unregistered trademarks Fairchild Semiconductor owns or is authorized to use and is not intended to be an exhaustive list of all such trademarks.

ACEx™	FACT Quiet Series™	OCX™	SILENT SWITCHER®	UniFET™
ActiveArray™	GlobalOptoisolator™	OCXPro™	SMART START™	VCX™
Bottomless™	GTO™	OPTOLOGIC®	SPM™	Wire™
Build it Now™	HiSeC™	OPTOPLANAR™	Stealth™	
CoolFET™	I ² C™	PACMAN™	SuperFET™	
CROSSVOLT™	i-Lo™	POP™	SuperSOT™-3	
DOME™	ImpliedDisconnect™	Power247™	SuperSOT™-6	
EcoSPARK™	IntelliMAX™	PowerEdge™	SuperSOT™-8	
E ² CMOS™	ISOPLANAR™	PowerSaver™	SyncFET™	
EnSigna™	LittleFET™	PowerTrench®	TCM™	
FACT®	MICROCOUPLER™	QFET®	TinyBoost™	
FAST®	MicroFET™	QS™	TinyBuck™	
FASTr™	MicroPak™	QT Optoelectronics™	TinyPWM™	
FPS™	MICROWIRE™	Quiet Series™	TinyPower™	
FRFET™	MSX™	RapidConfigure™	TinyLogic®	
	MSXPro™	RapidConnect™	TINYOPTO™	
Across the board. Around the world.™		µSerDes™	TruTranslation™	
The Power Franchise®		ScalarPump™	UHC®	
Programmable Active Droop™				

DISCLAIMER

FAIRCHILD SEMICONDUCTOR RESERVES THE RIGHT TO MAKE CHANGES WITHOUT FURTHER NOTICE TO ANY PRODUCTS HEREIN TO IMPROVE RELIABILITY, FUNCTION OR DESIGN. FAIRCHILD DOES NOT ASSUME ANY LIABILITY ARISING OUT OF THE APPLICATION OR USE OF ANY PRODUCT OR CIRCUIT DESCRIBED HEREIN; NEITHER DOES IT CONVEY ANY LICENSE UNDER ITS PATENT RIGHTS, NOR THE RIGHTS OF OTHERS. THESE SPECIFICATIONS DO NOT EXPAND THE TERMS OF FAIRCHILD'S WORLDWIDE TERMS AND CONDITIONS, SPECIFICALLY THE WARRANTY THEREIN, WHICH COVERS THESE PRODUCTS.

LIFE SUPPORT POLICY

FAIRCHILD'S PRODUCTS ARE NOT AUTHORIZED FOR USE AS CRITICAL COMPONENTS IN LIFE SUPPORT DEVICES OR SYSTEMS WITHOUT THE EXPRESS WRITTEN APPROVAL OF FAIRCHILD SEMICONDUCTOR CORPORATION.

As used herein:

- Life support devices or systems are devices or systems which, (a) are intended for surgical implant into the body, or (b) support or sustain life, or (c) whose failure to perform when properly used in accordance with instructions for use provided in the labeling, can be reasonably expected to result in significant injury to the user.
- A critical component is any component of a life support device or system whose failure to perform can be reasonably expected to cause the failure of the life support device or system, or to affect its safety or effectiveness.

PRODUCT STATUS DEFINITIONS

Definition of Terms

Datasheet Identification	Product Status	Definition
Advance Information	Formative or In Design	This datasheet contains the design specifications for product development. Specifications may change in any manner without notice.
Preliminary	First Production	This datasheet contains preliminary data, and supplementary data will be published at a later date. Fairchild Semiconductor reserves the right to make changes at any time without notice in order to improve design.
No Identification Needed	Full Production	This datasheet contains final specifications. Fairchild Semiconductor reserves the right to make changes at any time without notice in order to improve design.
Obsolete	Not In Production	This datasheet contains specifications on a product that has been discontinued by Fairchild semiconductor. The datasheet is printed for reference information only.

Rev. 122