

*Customer:

SPECIFICATION

ITEM	FLASH LED DEVICE
MODEL	FCW100Z
REVISION DATE	Rev1.2(070727)

[Contents]

1. Features
2. Absolute maximum ratings
3. Electro-optical characteristics
4. Soldering profile
5. Outline dimension
6. Reel dimension
7. Packing
8. Precaution for use

Drawn by	Checked by	Approved by



1. Features

- Package : 2.0 × 1.5 × 0.45 mm
- Color coordinates: according to CIE 1931
- Tape and reel packing

2. Absolute Maximum Ratings

(Ta=25℃)

Parameter	Symbol	Value	Unit
Power Dissipation	P_d	900	mW
Forward Current	I_F	175	mA
Peak Forward Current	I_{FM}^{*1}	600	mA
Reverse Voltage	V_R	5	V
Operating Temperature	T_{opr}	-30 ~ 85	℃
Storage Temperature	T_{stg}	-40 ~ 100	℃

*1 I_{FM} conditions: Pulse width $T_w \leq 300ms$, Duty ratio $\leq 1/10$

3. Electro-Optical Characteristics

(Ta=25℃)

Characteristics	Symbol	Condition	Min	Typ	Max	Unit
Forward Voltage	V_F	$I_F=175mA$	-	3.0	-	V
Reverse Current	I_R	$V_R=5V$	-	-	50	μA
Luminous Intensity ^{*2}	I_V	$I_F=175mA$	6	8	-	cd
		$I_F=320mA$ (Flash mode) ^{*3}	-	13	-	
		$I_F=600mA$ (Peak current mode) ^{*4}	-	20	-	
Illumination	I_x	$I_F=320mA$ (Flash mode) ^{*3}		26.5		$I_x@0.7m$
				13		$I_x@1m$
Chromaticity Coordinates	X	$I_F=175mA$	-	0.31	-	
	Y	$I_F=175mA$	-	0.32	-	
Viewing Angle	$\Delta 1/2\theta$	$I_F=175mA$	-	130	-	°

*2 The luminous intensity I_V is measured at the peak of the spatial pattern which may not be aligned with the mechanical axis of the LED package.

*3 Flash mode condition is Pulse width $T_w = 2sec$, Duty ratio = 2 / 7

*4 Peak current mode is Pulse width $T_w \leq 300ms$, Duty ratio $\leq 1/10$

[Note] (Tolerance : I_V 10%, color coordinate 0.01, V_F 0.1)

Forward Current vs. Forward Voltage

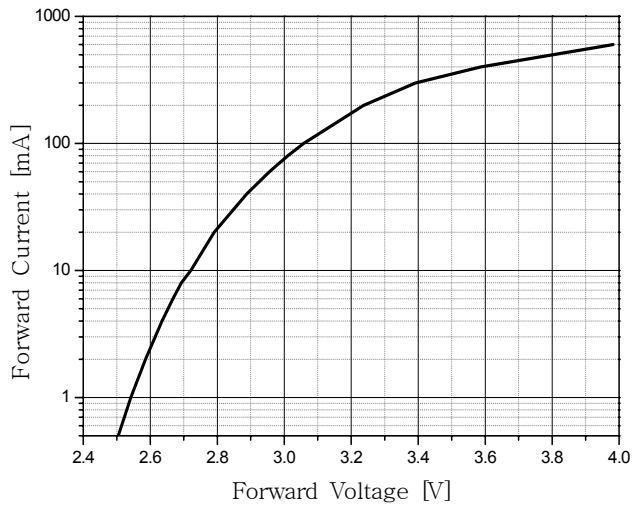

Luminous Intensity vs. Forward Current

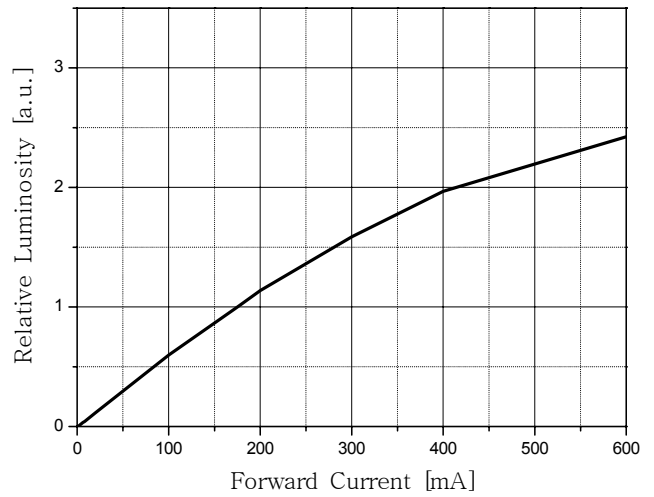

Forward Current Derate Curve

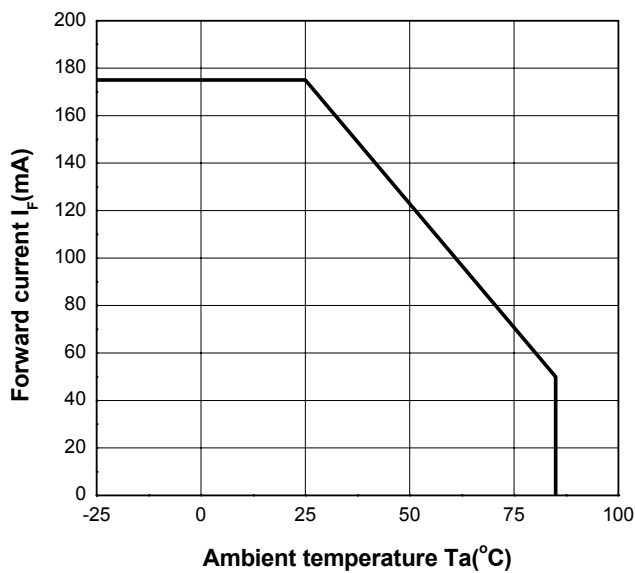

Forward Current vs Chromaticity Coordinate

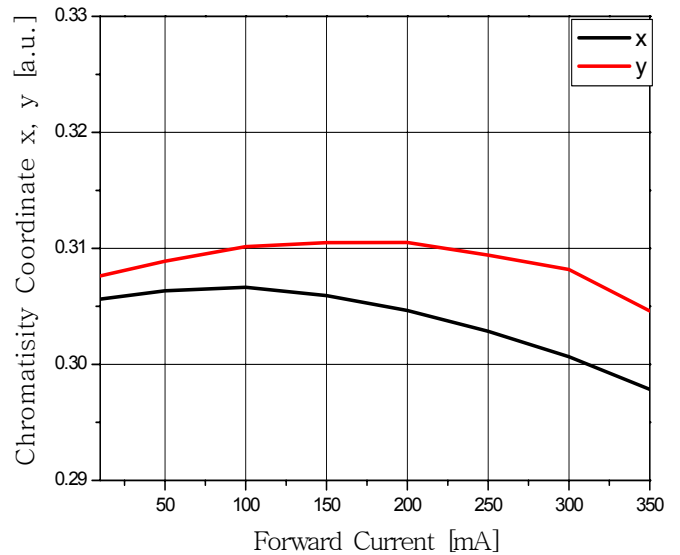

(Ta=25°C)

Radiation Diagram

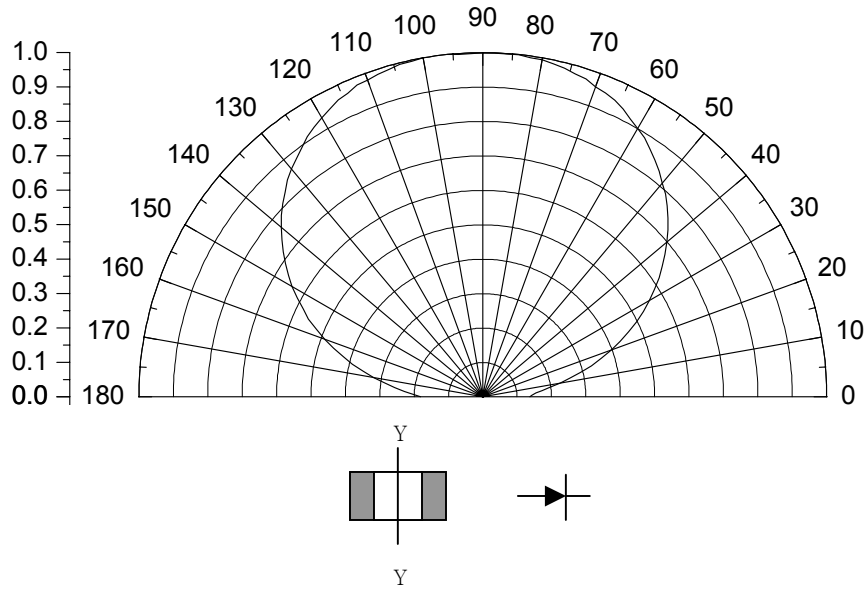

Spectrum

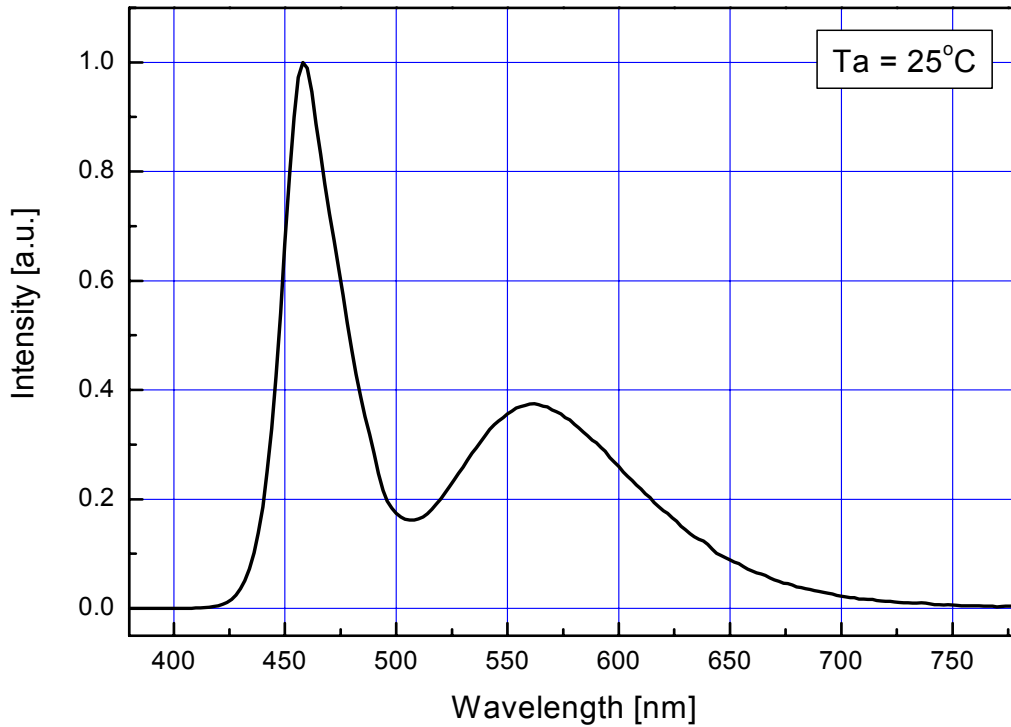

4. Soldering Profile

Reflow Soldering Conditions/ Profile

(1) Lead Solder

-Preliminary heating to be at 150°C max. for 2 minutes max.

-Soldering heat to be at 240°C max. for 5 seconds max.

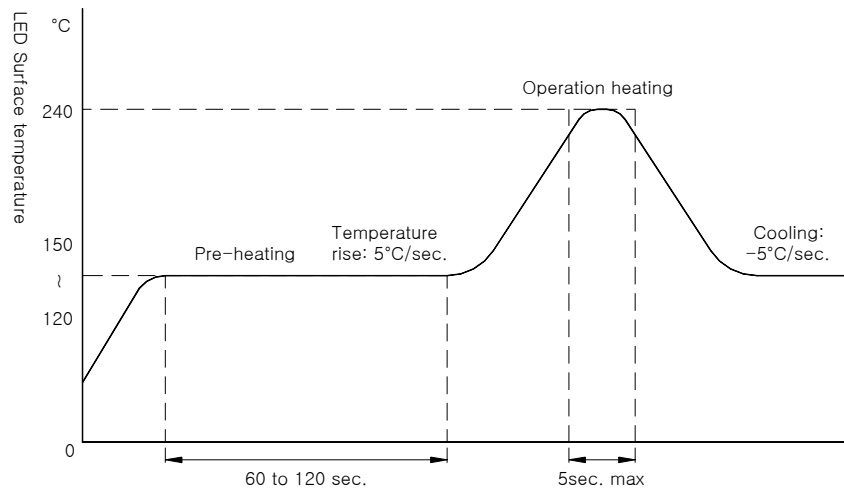

(2) Lead-Free Solder

-Preliminary heating to be at 150°C max. for 2 minutes max.

-Soldering heat to be at 260°C max. for 10 seconds max.

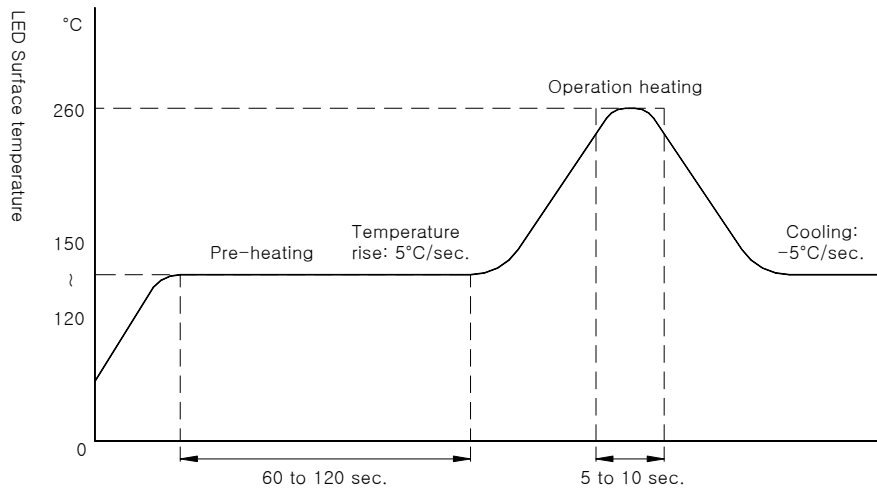

(3) Hand Soldering conditions

-Not more than 3 seconds @MAX280°C, under Soldering iron.

5. Outline Dimension

Tolerance: ± 0.05 , Unit: mm

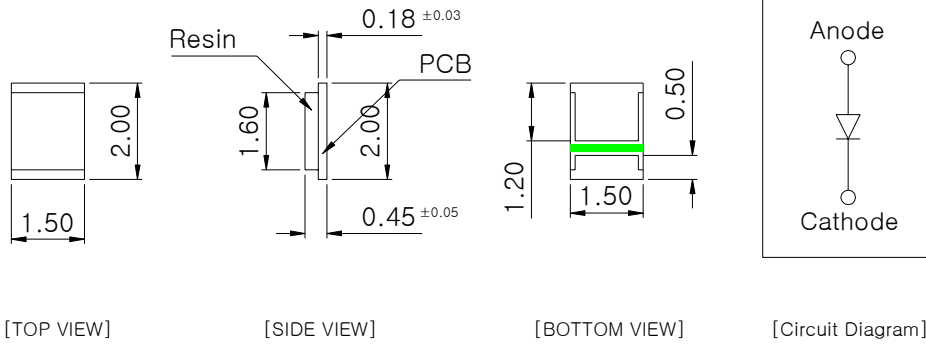

* Recommend Solder PAD Pattern

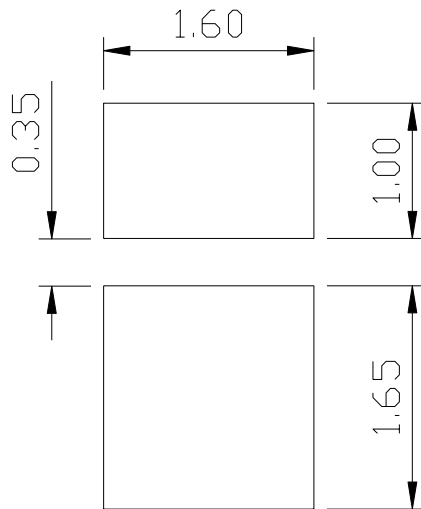

- Please refer to the "Thermal Design Guideline for Hi Power Flash LED" for heat dissipation pattern design.

6. Reel Dimension

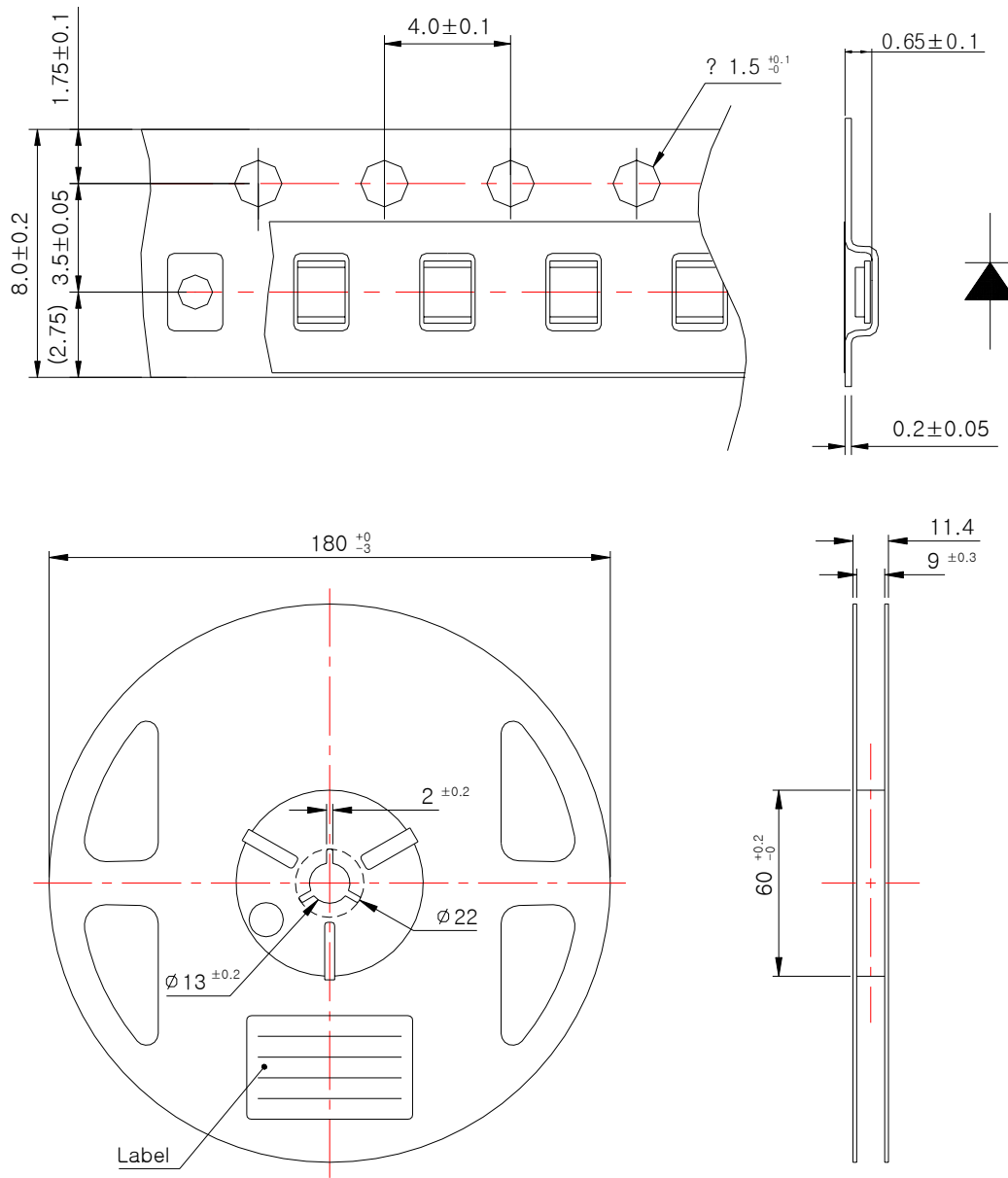

Tolerance: ± 0.2 , Unit: mm

- (1) Quantity : 2000pcs/Reel
- (2) Cumulative Tolerance : Cumulative Tolerance/10 pitches to be ± 0.2 mm
- (3) Adhesion Strength of Cover Tape : Adhesion strength to be 0.1-0.7N when the cover tape is turned off from the carrier tape at 10°C angle to be the carrier tape
- (4) Package : P/N, Manufacturing data Code No. and quantity to be indicated on a damp proof Package

7. Packing

Reel

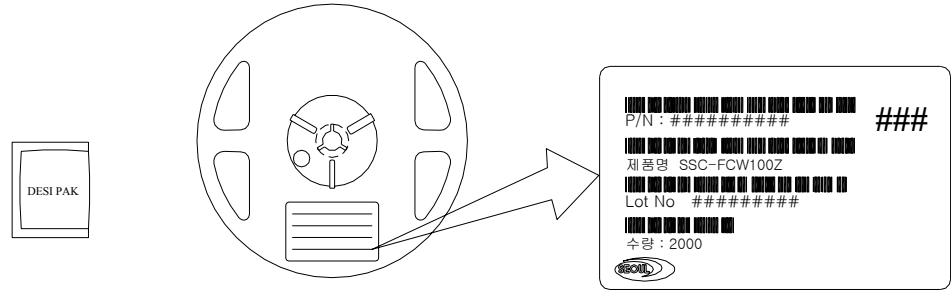

Aluminum Vinyl Bag

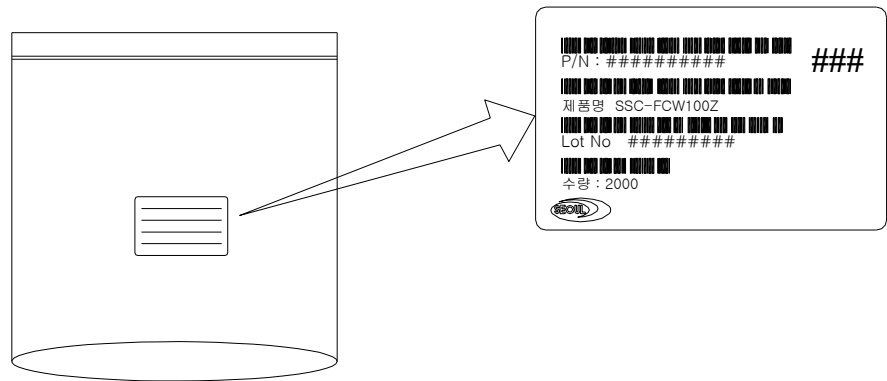

Outer Box

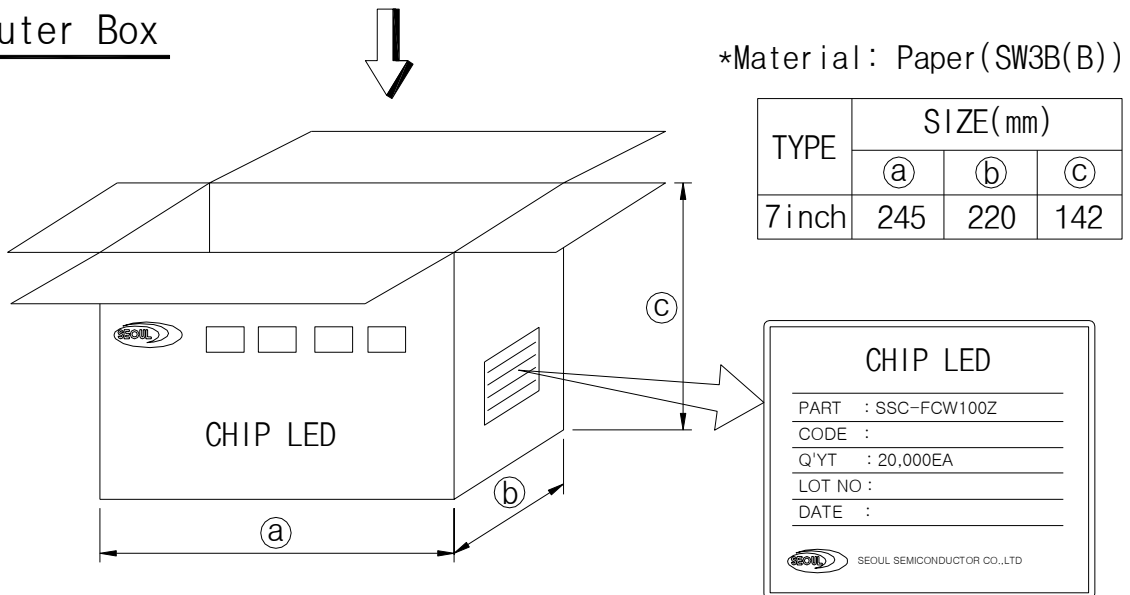

8. Precaution for use

(1) Storage

In order to avoid the absorption of moisture, it is recommended to store in the dry box (or desiccator) with a desiccant . Otherwise, to store them in the following environment is recommended.

Temperature : 5 °C~30 °C Humidity : 60%HR max.

(2) Attention after opened

However LED is corresponded SMD, when LED be soldered dip, interfacial separation may affect the light transmission efficiency, causing the light intensity to drop. Attention in followed.

a. After opened and mounted, the soldering shall be quickly. b. Keeping of a fraction

Temperature : 5 ~ 40 °C Humidity : less than 30%

(3) In case of more than 1 week passed after opening or change color of indicator on desiccant components shall be dried 10-12hr. at 60±5 °C.

(4) In case of supposed the components is humid, shall be dried dip-solder just before.

100Hr at 80±5 °C or 12Hr at 100±5 °C.

(5) Any mechanical force or any excess vibration shall not be accepted to apply during cooling process to normal temp. after soldering.

(6) Quick cooling shall not be avoid.

(7) Components shall not be mounted on warped direction of PCB.

(8) Anti radioactive ray design is not considered for the products listed here in.

(9) This device should not be used in any type of fluid such as water, oil, organic solvent and etc. When washing is required, IPA should be used.

(10) When the LEDs are illuminating, operating current should be decided after considering the ambient maximum temperature.

(11) LEDs must be stored to maintain a clean atmosphere. If the LEDs are stored for 3 months or more after being shipped from SSC, a sealed container with a nitrogen atmosphere should be used for storage.

(12) The LEDs must be soldered within seven days after opening the moisture-proof packing.

(13) Repack unused products with anti-moisture packing, fold to close any opening and then store in a dry place.

(14) The appearance and specifications of the product may be modified for improvement without notice.

(15) Static Electricity and surge damages the Blue LEDs.

It is recommended to use a wrist band or anti-electrostatic glove when handling the LEDs.

All devices, equipment and machinery must be properly grounded.

(16) It is recommended to use individual resistor separately when the LEDs applies in parallel circuit so that it may improve the light deviations.