



WBFBP-06C Plastic-Encapsulate Diode

FBAS40DW-04

SURFACE MOUNT SCHOTTKY BARRIER DIODE ARRAYS

DESCRIPTION

Silicon epitaxial planar
PN Junction Guard Ring for Schottky Diode

FEATURES

- Low Forward Voltage Drop
- Fast Switching
- Ultra-Small Surface Mount Package

APPLICATION

For General Purpose Switching Applications, rectifiers
For portable equipment:(i.e. Mobile phone,MP3, MD,CD-ROM,
DVD-ROM, Note book PC, etc.)

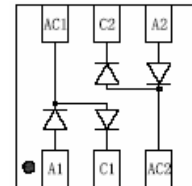
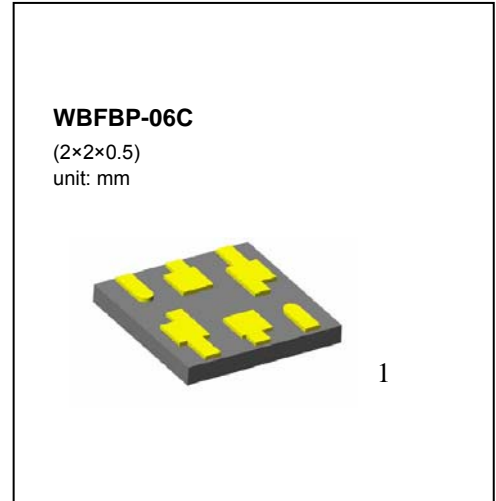

FBAS40DW-04
Marking:K44

Maximum Ratings @T_A=25°C

Parameter	Symbol	Limits	Unit
Peak Repetitive reverse voltage	V _{RM}	40	V
DC Blocking Voltage	V _R		
Average Rectified Output Current	I _O	40	mA
Power Dissipation	P _d	150	mW
Thermal Resistance. Junction to Ambient Air	R _{θJA}	625	°C/W
Junction temperature	T _J	125	°C
Storage temperature range	T _{STG}	-65-125	°C

ELECTRICAL CHARACTERISTICS (T_{amb}=25°C unless otherwise specified)

Parameter	Symbol	Test conditions	MIN	MAX	UNIT
Reverse voltage leakage current	I _R	V _R =30V		200	nA
Forward voltage	V _F	I _F =1mA I _F =40mA		380 1000	mV
Total capacitance	C _T	V _R =0,f=1MHz		5	pF
Reverse recovery time	t _{rr}	I _F = I _R =10mA,I _{rr} =0.1×I _R , R _L =100 Ω		5	nS

Typical Characteristics

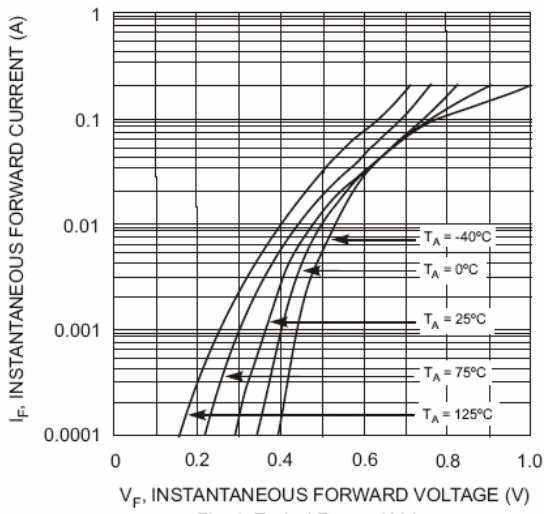

Fig. 1 Typical Forward Voltage

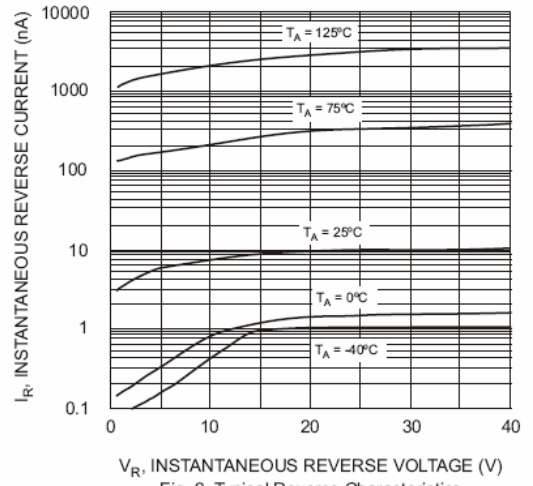

Fig. 2 Typical Reverse Characteristics

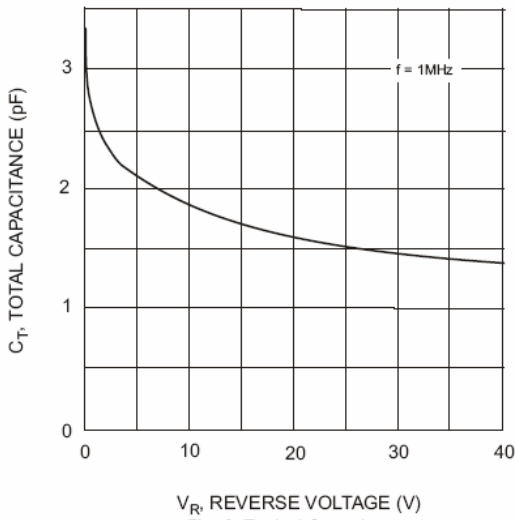

Fig. 3 Typical Capacitance

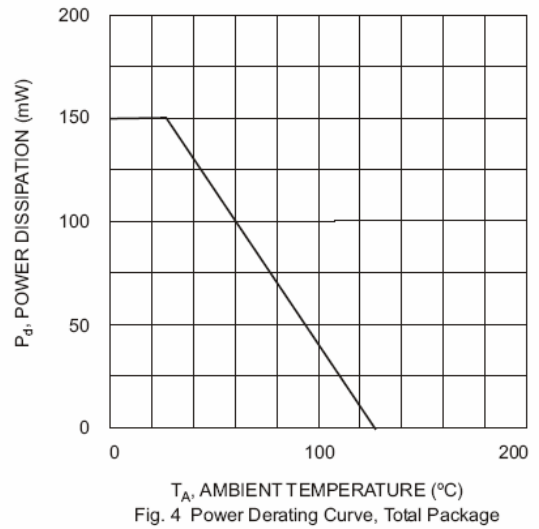
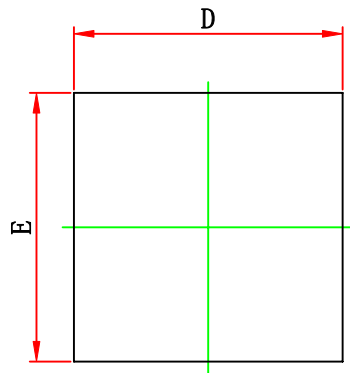

Fig. 4 Power Derating Curve, Total Package



WBFBP-06C(2×2×0.5) PACKAGE OUTLINE DIMENSIONS



TOP VIEW

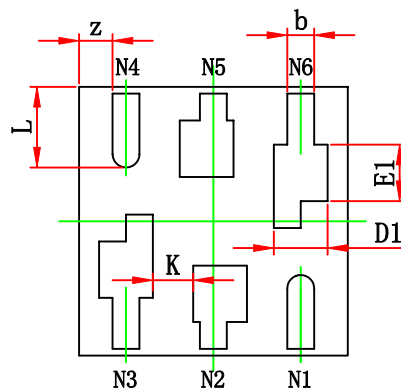

BOTTOM VIEW

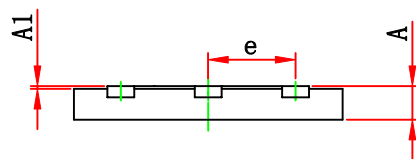

SIDE VIEW

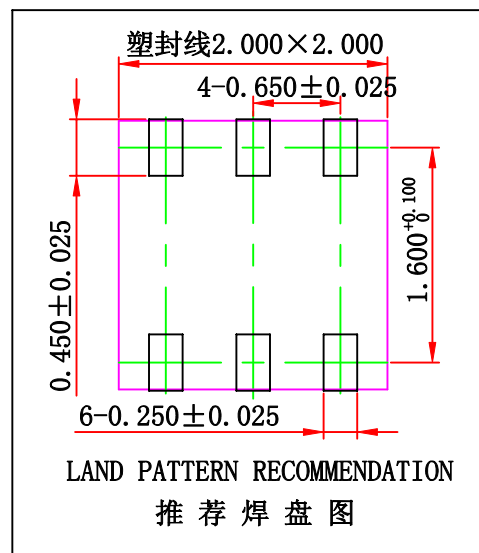

Symbol	Dimensions In Millimeters		Dimensions In Inches	
	Min.	Max.	Min.	Max.
A	0.450	0.550	0.018	0.022
A1	0.000	0.100	0.000	0.004
b	0.150	0.250	0.006	0.010
D	1.900	2.100	0.075	0.083
E	1.900	2.100	0.075	0.083
D1	0.420 REF.		0.017 REF.	
E1	0.420 REF.		0.017 REF.	
e	0.650 TYP.		0.026 TYP.	
L	0.600 REF.		0.024 REF.	
k	0.300 REF.		0.012 REF.	
z	0.500 REF.		0.020 REF.	

APPLICATION CIRCUITS

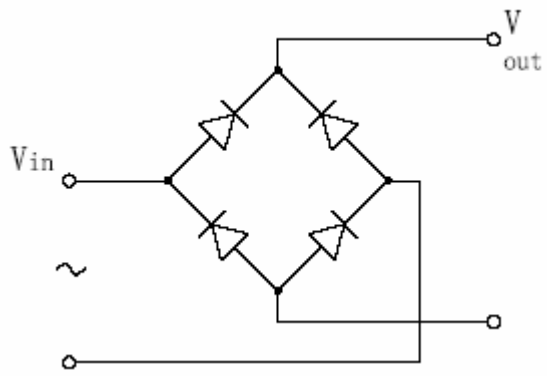

Bridge rectifiers