

FAN7602

Green Current Mode PWM Controller

Features

- Green Current Mode PWM Control
- Fixed 65kHz Operation with Frequency Modulation
- Internal High-Voltage Start-up Switch
- Burst Mode Operation
- Line Voltage Feed Forward to Limit Maximum Power
- Line Under-Voltage Protection
- Latch Protection & Internal Soft-Start (10ms) Function
- Overload Protection
- Over Voltage Protection
- Low Operation Current: Typ. 1mA
- 8-pin DIP

Applications

- Adapter
- LCD Monitor Power
- Auxiliary Power Supply

Related Application Notes

- **AN6014** - Green Current Mode PWM Controller FAN7602

Description

The FAN7602 is a green current mode PWM controller. It is specially designed for off-line adapter application, DVDP, VCR, LCD monitor application, and auxiliary power supplies.

The internal high-voltage start-up switch and the burst mode operation reduce the power loss in standby mode. Because of the internal start-up switch and the burst mode, it is possible to supply 0.5W load limiting the input power under 1W when the input line voltage is 265Vac. On no-load condition, the input power is under 0.3W.

The maximum power can be limited constantly, regardless of the line voltage change using the power limit function.

The switching frequency is internally fixed to be 65kHz and the frequency modulation technique reduces EMI.

The FAN7602 includes various protections for the system reliability and the internal soft start prevents the output voltage over-shoot at start-up.

Ordering Information

Part Number	Operating Temp. Range	Pb-Free	Package	Packing Method	Marking Code
FAN7602N	-25°C to +125°C	Yes	8-DIP	Rail	FAN7602

Typical Application Diagram

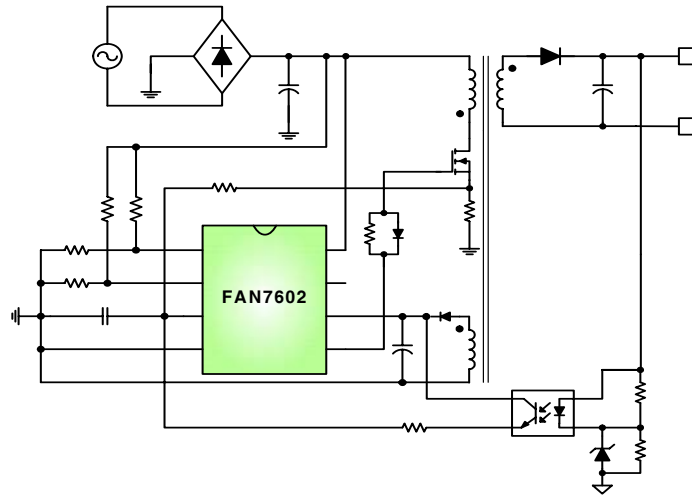

Figure 1. Typical Flyback Application

Internal Block Diagram

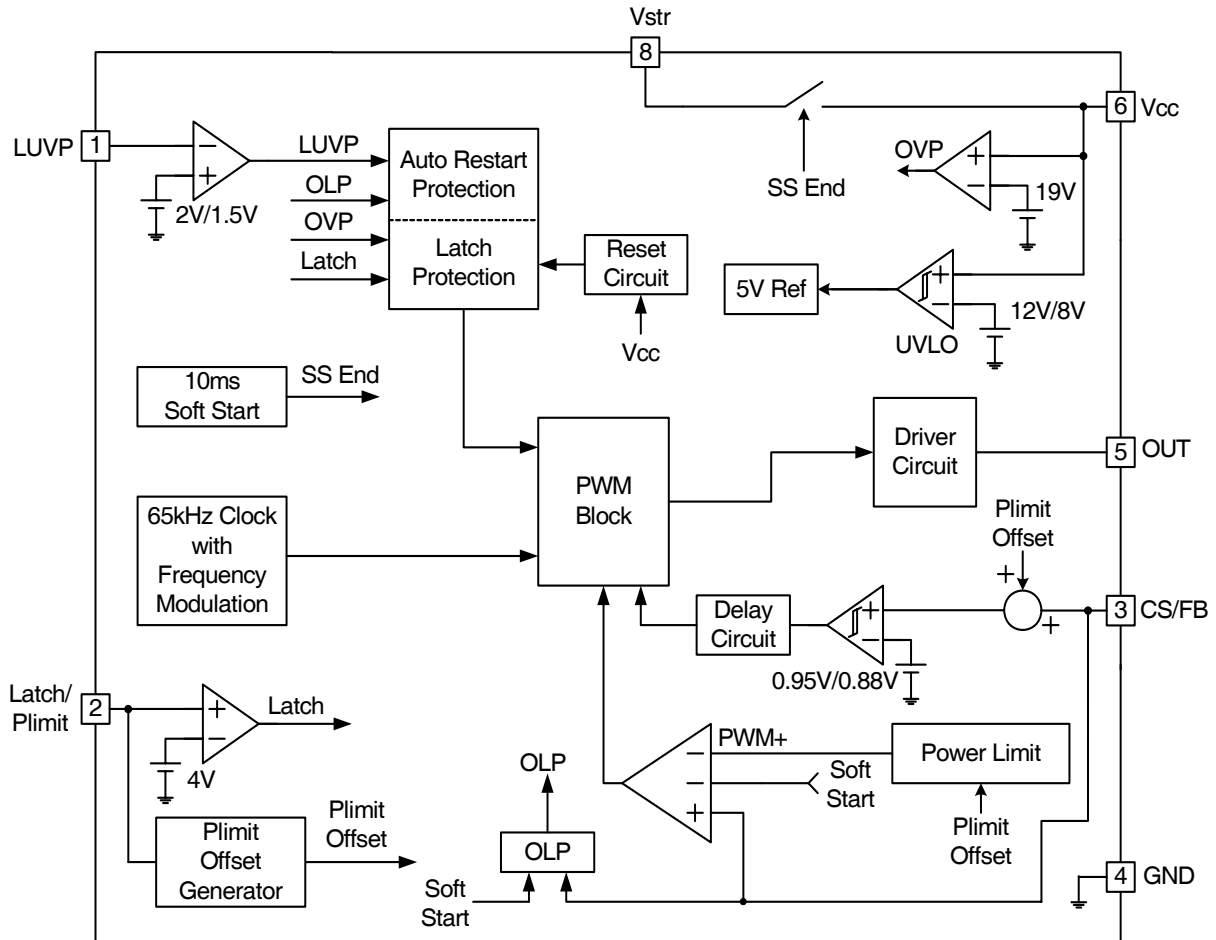

Figure 2. Functional Block Diagram of FAN7602

Pin Assignments

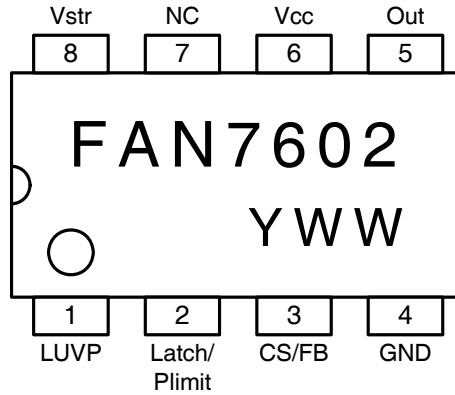

Figure 3. Pin Configuration (Top View)

Pin Definitions

Pin Number	Pin Name	Pin Function Description
1	LUVP	Line Under Voltage Protection Pin. This pin is used to protect the set when the input voltage is lower than the rated input voltage range.
2	Latch/Plimit	Latch Protection and Power Limit Pin. When the pin voltage exceeds 4V, the latch protection works and the latch protection is reset when the Vcc voltage is lower than 5V. For the power limit function, the OCP level decreases as the pin voltage increases.
3	CS/FB	Current Sense and Feedback Pin. This pin is used to sense the MOSFET current for the current mode PWM and OCP. The output voltage feedback information and the current sense information are added using external RC filter.
4	GND	Ground Pin. This pin is used for the ground potential of all the pins. For proper operation, the signal ground and the power ground should be separated.
5	OUT	Gate Drive Output Pin. This pin is an output pin to drive an external MOSFET. The peak sourcing current is 450mA and the peak sinking current is 600mA. For proper operation, the stray inductance in the gate driving path must be minimized.
6	Vcc	Supply Voltage Pin. IC operating current and MOSFET driving current are supplied using this pin.
7	NC	No Connection.
8	Vstr	Start-up Pin. This pin is used to supply IC operating current during IC start-up. After start-up, the internal JFET is turned off to reduce power loss.

Absolute Maximum Ratings

The “Absolute Maximum Ratings” are those values beyond which the safety of the device cannot be guaranteed. The device should not be operated at these limits. The parametric values defined in the Electrical Characteristics tables are not guaranteed at the absolute maximum ratings. The “Recommended Operating Conditions” table defines the conditions for actual device operation.

Symbol	Parameter	Value	Unit
V _{CC}	Supply Voltage	20	V
I _{OH} , I _{OL}	Peak Drive Output Current	+450/-600	mA
V _{CS/FB}	CS/FB Input Voltage	-0.3 to 20	V
V _{LUVP}	LUVP Input Voltage	-0.3 to 10	V
V _{Latch}	Latch/Plimit Input Voltage	-0.3 to 10	V
V _{str}	Vstr Input Voltage	600	V
T _j	Operating Junction Temperature	150	°C
T _{opr}	Operating Temperature Range	-25 to 125	°C
T _{stg}	Storage Temperature Range	-55 to 150	°C
P _D	Power Dissipation	1.2	W
V _{ESD_HBM}	ESD Capability, Human Body Model	2.0	kV
V _{ESD_MM}	ESD Capability, Machine Model	300	V
V _{ESD_CDM}	ESD Capability, Charged Device Model	500	V

Thermal Impedance

Symbol	Parameter	Value	Unit	
R _{θja}	Thermal Resistance, Junction to Ambient	8-DIP	100	°C/W

Note:

- Regarding the test environment and PCB type, please refer to JESD51-2 and JESD51-10.

Electrical Characteristics

($V_{CC} = 14V$, $T_A = -25^{\circ}C \sim 125^{\circ}C$, unless otherwise specified)

Symbol	Parameter	Condition	Min.	Typ.	Max.	Unit
START UP SECTION						
I_{str}	Vstr Start-up Current	$V_{str} = 30V$, $T_A = 25^{\circ}C$	0.7	1	1.4	mA
UNDER VOLTAGE LOCK OUT SECTION						
$V_{th(start)}$	Start Threshold Voltage	V_{CC} increasing	11	12	13	V
$V_{th(stop)}$	Stop Threshold Voltage	V_{CC} decreasing	7	8	9	V
$HY(uvlo)$	UVLO Hysteresis		3.6	4	4.4	V
SUPPLY CURRENT SECTION						
I_{st}	Start-up Supply Current	$T_A = 25^{\circ}C$	-	250	320	μA
I_{cc}	Operating Supply Current	Output no switching	-	1	1.5	mA
SOFT START SECTION						
T_{ss}	Soft Start Time ⁽¹⁾		5	10	15	ms
PWM SECTION						
F_{OSC}	Operating Frequency	$V_{CS/FB} = 0.2V$, $T_A = 25^{\circ}C$	59	65	73	kHz
ΔF	Frequency Modulation		-	± 2	-	kHz
$V_{CS/FB1}$	CS/FB Threshold Voltage	$T_A = 25^{\circ}C$	0.9	1.0	1.1	V
T_D	Propagation Delay to Output ⁽¹⁾		-	100	150	ns
D_{MAX}	Maximum Duty Cycle		70	75	80	%
D_{MIN}	Minimum Duty Cycle		-	-	0	%
BURST MODE SECTION						
$V_{CS/FB2}$	Burst On Threshold Voltage	$T_A = 25^{\circ}C$	0.84	0.95	1.06	V
$V_{CS/FB3}$	Burst Off Threshold Voltage	$T_A = 25^{\circ}C$	0.77	0.88	0.99	V
POWER LIMIT SECTION						
K_{Plimit}	Offset Gain	$V_{Latch/Plimit} = 2V$, $T_A = 25^{\circ}C$	0.12	0.16	0.20	
OUTPUT SECTION						
V_{OH}	Output Voltage High	$T_A = 25^{\circ}C$, $I_{source} = 100mA$	11.5	12	14	V
V_{OL}	Output Voltage Low	$T_A = 25^{\circ}C$, $I_{sink} = 100mA$	-	1	2.5	V
T_r	Rising Time ⁽¹⁾	$T_A = 25^{\circ}C$, $Cl = 1nF$	-	45	150	ns
T_f	Falling Time ⁽¹⁾	$T_A = 25^{\circ}C$, $Cl = 1nF$	-	35	150	ns

Note:

1. These parameters, although guaranteed by design, are not tested in mass production.

Electrical Characteristics (Continued)(V_{CC} = 14V, T_A = -25°C~125°C, unless otherwise specified)

Symbol	Parameter	Condition	Min.	Typ.	Max.	Unit
PROTECTION SECTION						
V _{Latch}	Latch Voltage		3.6	4	4.4	V
T _{OLP}	Overload Protection Time ⁽¹⁾		20	22	24	ms
T _{OLP_ST}	Overload Protection Time at Start-up		30	37	44	ms
V _{OLP}	Overload Protection Level		-	0	0.1	V
V _{LUVPoff}	Line Under-Voltage Protection On to Off	T _A = 25°C	1.9	2	2.1	V
V _{LUVPon}	Line Under-Voltage Protection Off to On	T _A = 25°C	1.4	1.5	1.6	V
V _{OVP}	Over Voltage Protection	T _A = 25°C	18	19	20	V

Note:

1. These parameters, although guaranteed by design, are not tested in mass production.

Typical Performance Characteristics

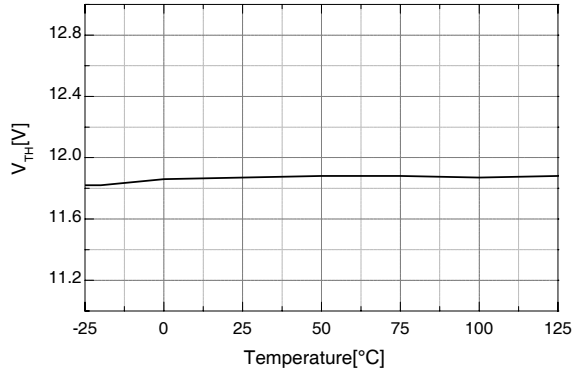

Figure 4. Start Threshold Voltage vs. Temp.

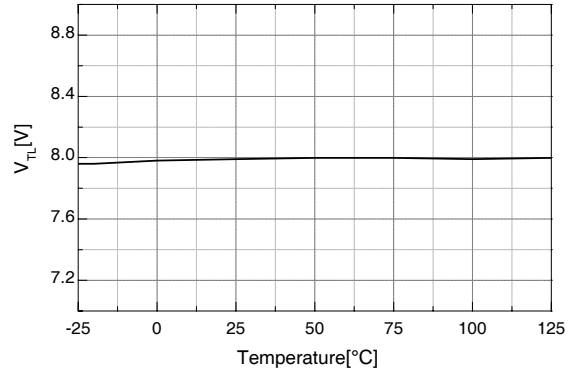

Figure 5. Stop Threshold Voltage vs. Temp.

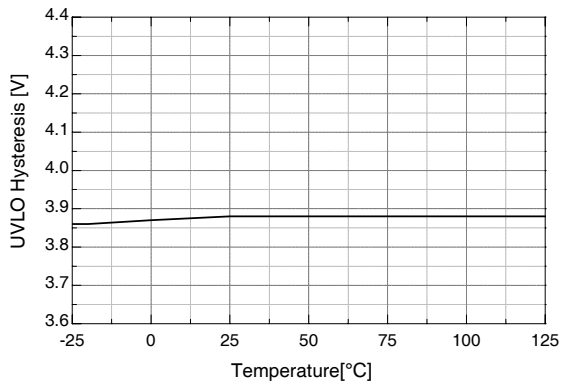

Figure 6. UVLO Hysteresis vs. Temp.

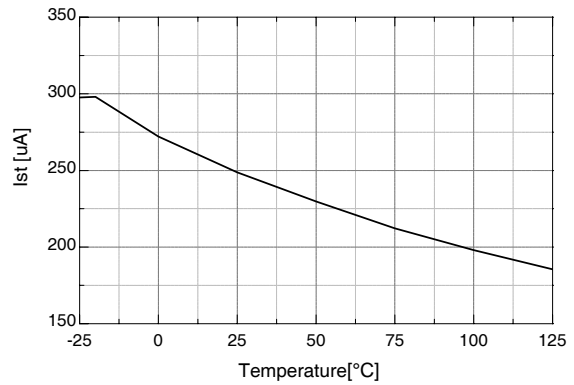

Figure 7. Start-up Supply Current vs. Temp.

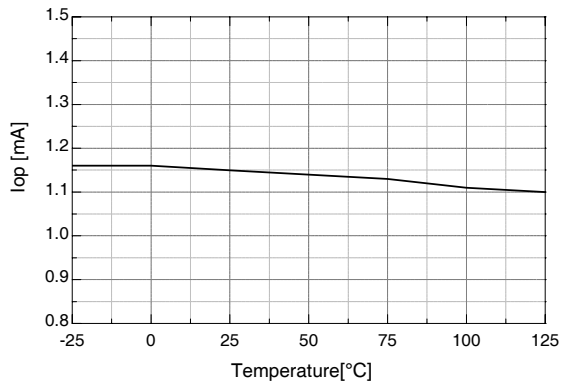

Figure 8. Operating Supply Current vs. Temp.

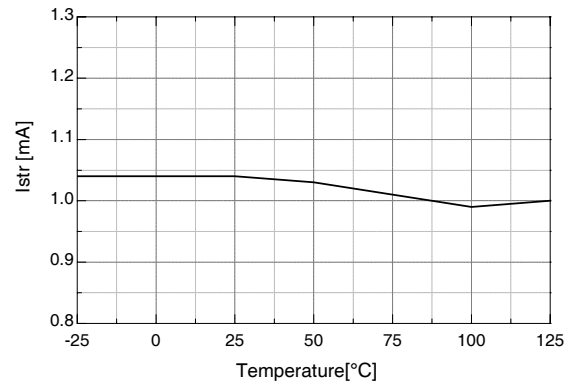

Figure 9. Vstr Star-up Current vs. Temp.

Typical Performance Characteristics (Continued)

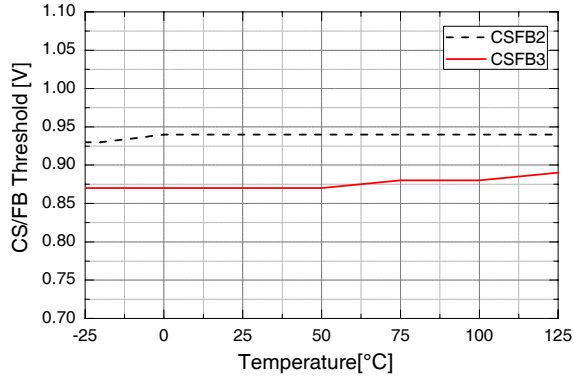

Figure 10. Burst On/Off Voltage vs. Temp.

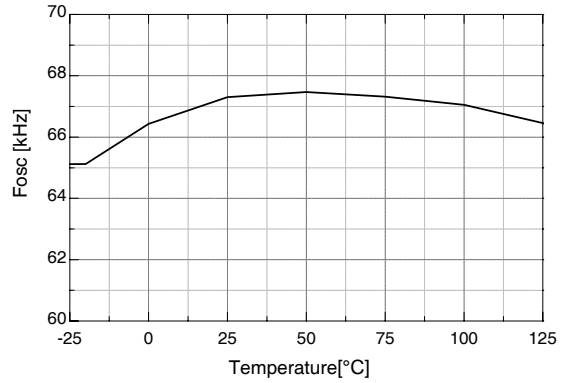

Figure 11. Operating Frequency vs. Temp.

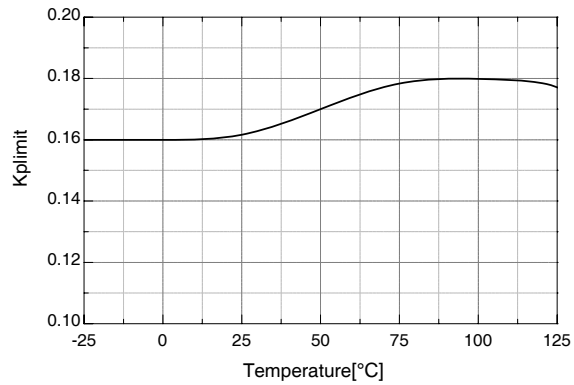

Figure 12. Offset Gain vs. Temp.

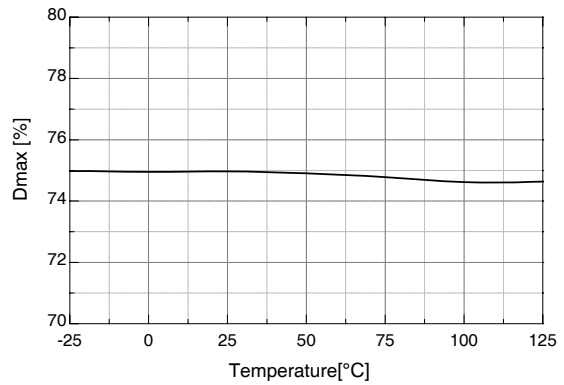

Figure 13. Maximum Duty Cycle vs. Temp.

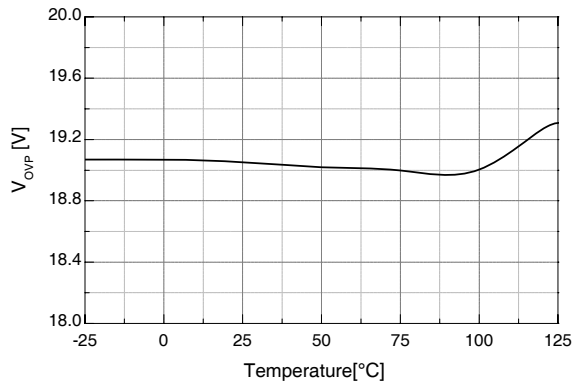

Figure 14. OVP Voltage vs. Temp.

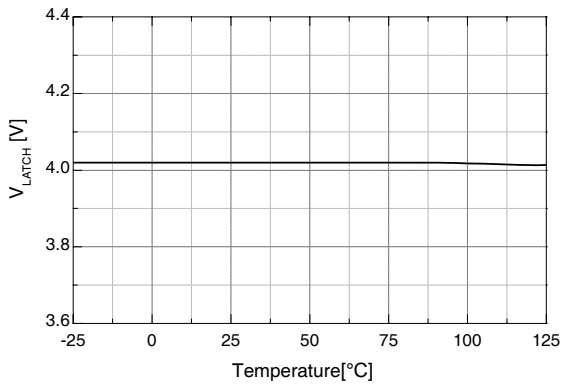

Figure 15. Latch Voltage vs. Temp.

Typical Performance Characteristics (Continued)

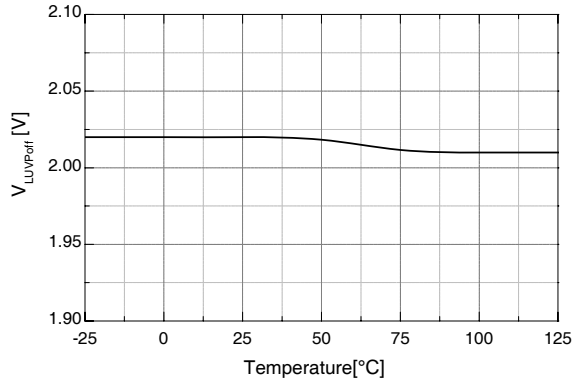

Figure 16. LUVP On to Off Voltage vs. Temp.

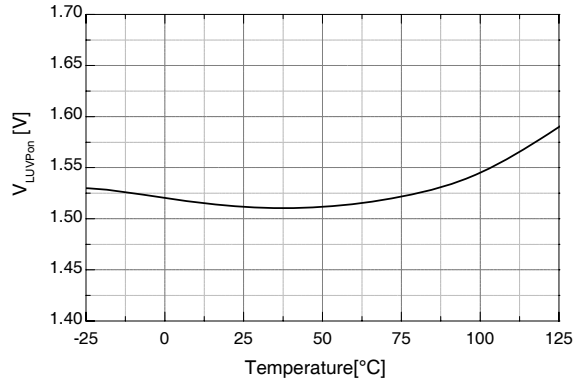

Figure 17. LUVP Off to On Voltage vs. Temp.

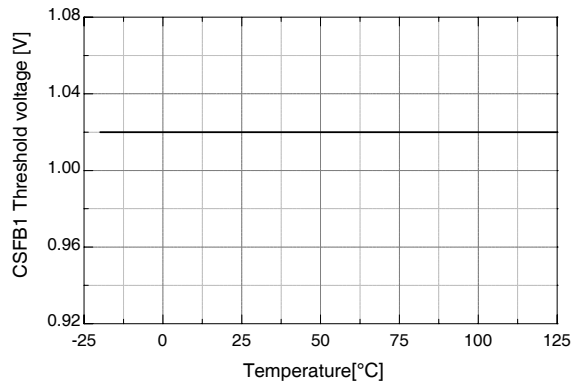

Figure 18. CS/FB Threshold Voltage vs. Temp.

Applications Information

1. Start-up Circuit and Soft Start Block

The FAN7602 contains a start-up switch to reduce the power loss of the external start-up circuit of the conventional PWM converters. The internal start-up circuit charges the Vcc capacitor with 0.9mA current source if the AC line is connected. The start-up switch is turned off 15ms after IC starts up, as shown in Fig. 19. The soft-start function starts when the Vcc voltage reaches the start threshold voltage of 12V and ends when the internal soft-start voltage reaches 1V. The internal start-up circuit starts charging the Vcc capacitor again if the Vcc voltage is lowered to the minimum operating voltage, 8V. The UVLO block shuts down the output drive circuit and some blocks to reduce the IC operating current and the internal soft-start voltage drops to zero. If the Vcc voltage reaches the start threshold voltage, the IC starts switching again and the soft start block works as well.

During the soft start, pulse-width modulated (PWM) comparator compares the CS/FB pin voltage with the soft start voltage. The soft-start voltage starts from 0.5V and the soft-start ends when it reaches 1V and the soft-start time is 10ms. The start-up switch is turned off when the soft start voltage reaches 1.5V.

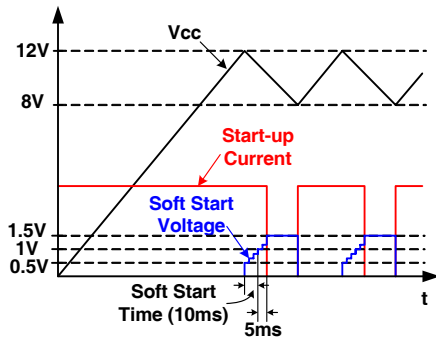

Figure 19. Start-up Current and Vcc Voltage

2. Oscillator Block

The oscillator frequency is set internally and a frequency modulation (FM) function reduces EMI. The average frequency is 65kHz and the modulation frequency is ± 2 kHz. The frequency varies from 63kHz to 67kHz with 16 steps. The frequency step is 250Hz and FM frequency is 125Hz, as shown in Fig. 20.

3. Current Sense and Feedback Block

The FAN7602 performs the current sensing for the current mode PWM and the output voltage feedback with only one pin, pin3. To achieve the two functions with one pin, an internal LEB (leading edge blanking) circuit to filter the current sense noise is not included because the external RC filter is necessary to add the output voltage

feedback information and the current sense information. Fig. 21 shows the current sense and feedback circuits. R_S is the current sense resistor to sense the switch current. The current sense information is filtered by an RC filter composed of R_F and C_F . According to the output voltage feedback information, I_{FB} charges or stops charging C_F to adjust the offset voltage. If I_{FB} is zero, C_F is discharged through R_F and R_S to lower the offset voltage.

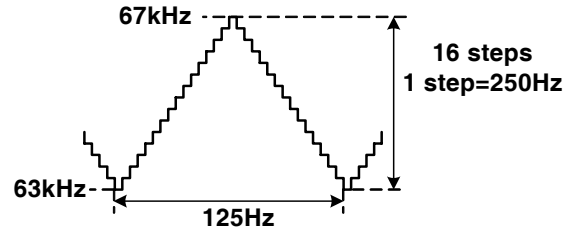

Figure 20. Frequency Modulation

Figure 22 shows typical voltage waveforms of the CS/FB pin. The current sense waveform is added to the offset voltage as shown in the figure. The CS/FB pin voltage is compared with PWM+ that is 1V - Plimit offset as shown in Fig. 22. If the CS/FB voltage meets PWM+, the output drive is shut off. As shown in Fig. 22, if the feedback offset voltage is low, the switch on time is increased. If the feedback offset voltage is high, then the switch on time is decreased. In this way, the duty cycle is controlled according to the output load condition. In general, the maximum output power increases as the input voltage increases because the current slope during switch on-time increases. To limit the output power of the converter constantly, the power limit function is included in the FAN7602. Sensing the converter input voltage through the Latch/Plimit pin, the Plimit offset voltage is subtracted from 1V. As shown in Fig. 22, the Plimit offset voltage is subtracted from 1V and the switch on-time decreases as the Plimit offset voltage increases. If the converter input voltage increases, the switch on-time decreases, controlling the output power constant. The offset voltage is proportional to the Latch/Plimit pin voltage and the gain is 0.16; if the Latch/Plimit voltage is 1V, the offset voltage is 0.16V.

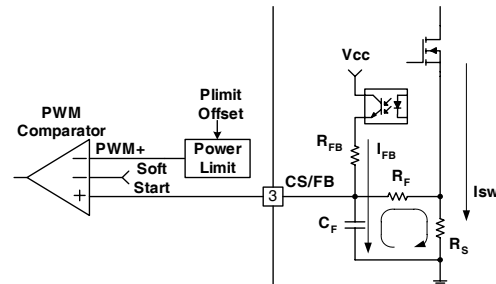

Figure 21. Current Sense and Feedback Circuits

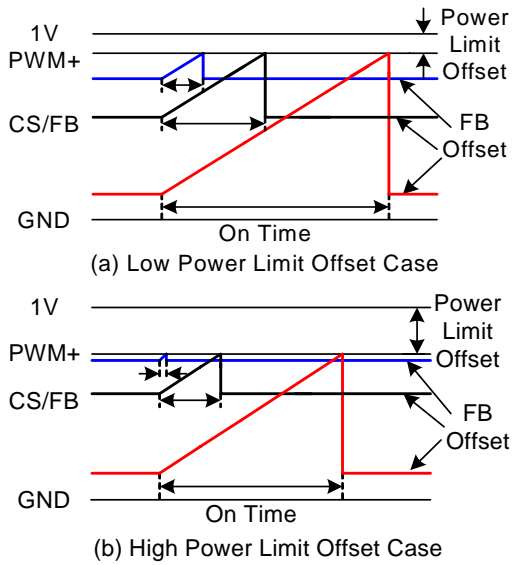

Figure 22. CS/FB Pin Voltage Waveforms

4. Burst Mode Block

The FAN7602 contains the burst mode block to reduce the power loss at a light load and no load as the FAN7601. A hysteresis comparator senses the offset voltage of the Burst+ for the burst mode as shown in Fig. 23. The Burst+ is the sum of the CS/FB voltage and Plimit offset voltage. The FAN7602 enters the burst mode when the offset voltage of the Burst+ is higher than 0.95V and exits the burst mode when the offset voltage is lower than 0.88V. The offset voltage is sensed during the switch off time.

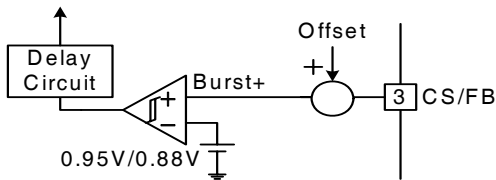

Figure 23. Burst Mode Block

5. Protection Block

The FAN7602 contains several protection functions to improve system reliability.

5.1 Overload Protection (OLP)

The FAN7602 contains the overload protection function. If the output load is higher than the rated output current, the output voltage drops and the feedback error amplifier is saturated. The offset of the CS/FB voltage representing the feedback information is almost zero. As shown in Fig. 24, the CS/FB voltage is compared with 50mV reference when the internal clock signal is high and, if the voltage is lower than 50mV, the OLP timer starts count-

ing. If the OLP condition persists for 22ms, the timer generates the OLP signal. And this protection is reset by the UVLO. The OLP block is enabled after the soft start finishes.

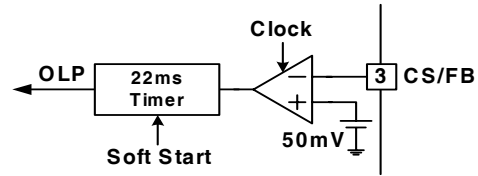

Figure 24. Overload Protection Circuit

5.2 Line Under Voltage Protection

If the input voltage of the converter is lower than the minimum operating voltage, the converter input current increases too much, causing component failure. Therefore, if the input voltage is low, the converter should be protected. In the FAN7602, the LUVVP circuit senses the input voltage using the LUVVP pin and, if this voltage is lower than 2V, the LUVVP signal is generated. The comparator has 0.5V hysteresis. If the LUVVP signal is generated, the output drive block is shut down, the output voltage feedback loop is saturated, and the OLP works if the LUVVP condition persists more than 22ms.

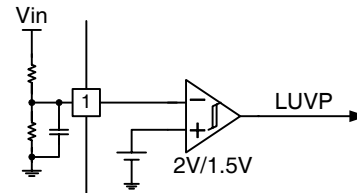

Figure 25. Line UVP Circuit

5.3 Latch Protection

The latch protection is provided to protect the system against abnormal conditions using the Latch/Plimit pin. The Latch/Plimit pin can be used for the output over-voltage protection and/or other protections. If the Latch/Plimit pin voltage is made higher than 4V by an external circuit, the IC is shut down. The latch protection is reset when the Vcc voltage is lower than 5V.

5.4 Over-Voltage Protection (OVP)

If the Vcc voltage reaches 19V, the IC shuts down and the OVP protection is reset when the Vcc voltage is lower than 5V.

6. Output Drive Block

The FAN7602 contains a single totem-pole output stage to drive a power MOSFET. The drive output is capable of up to 450mA sourcing current and 600mA sinking current with typical rise and fall time of 45ns, 35ns respectively with a 1nF load.

2. Inductor Schematic Diagram

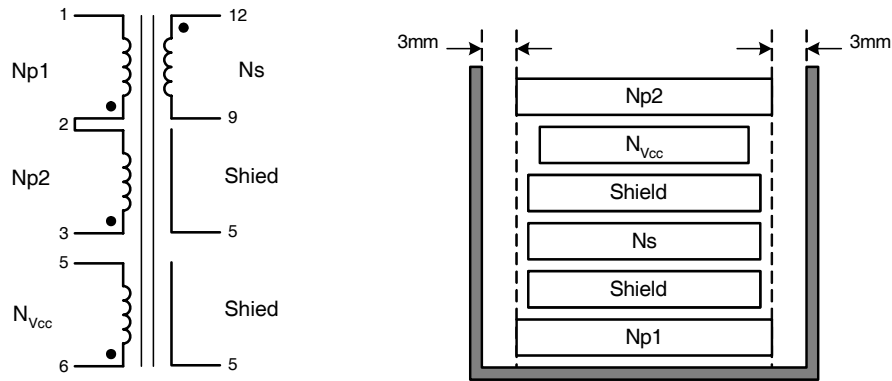

Figure 27. Inductor Schematic Diagram

3. Winding Specification

No	Pin (s→f)	Wire	Turns	Winding Method
Np1	3 → 2	0.3 ^φ × 2	31	Solenoid Winding
Insulation: Polyester Tape t = 0.03mm, 2 Layers				
Shield	5	Copper Tape	0.9	Not Shorted
Insulation: Polyester Tape t = 0.03mm, 2 Layers				
Ns	12 → 9	0.65 ^φ × 3	10	Solenoid Winding
Insulation: Polyester Tape t = 0.03mm, 2 Layers				
Shield	5	Copper Tape	0.9	Not Shorted
Insulation: Polyester Tape t = 0.03mm, 2 Layers				
N _{Vcc}	6 → 5	0.2 ^φ × 1	10	Solenoid Winding
Insulation: Polyester Tape t = 0.03mm, 2 Layers				
Np2	2 → 1	0.3 ^φ × 2	31	Solenoid Winding
Outer Insulation: Polyester Tape t = 0.03mm, 2 Layers				

4. Electrical Characteristics

	Pin	Specification	Remarks
Inductance	1 - 3	607μH	100kHz, 1V
Inductance	1 - 3	15μH	9 - 12 shorted

5. Core & Bobbin

- Core: EER2828
- Bobbin: EER2828
- Ae(mm²): 82.1

6. Demo Circuit Part List

Part	Value	Note	Part	Value	Note
Fuse			Capacitor		
FUSE	1A/250V		C101	220nF/275V	Box Capacitor
NTC			C102	150nF/275V	Box Capacitor
RT101	5D-9		C103, C104	102/1kV	Ceramic
Resistor			C105	150 μ F/400V	Electrolytic
R102, R112	10M Ω	1/4W	C106	103/630V	Film
R103	56k Ω	1/2W	C107	271	Ceramic
R104	150 Ω	1/4W	C108	103	Ceramic
R105	1k Ω	1/4W	C109	22 μ F/25V	Electrolytic
R106	0.5 Ω	1/2W	C110	473	Ceramic
R107	56k Ω	1/4W	C201, C202	1000 μ F/25V	Electrolytic
R108	10k Ω	1/4W	C203	102	Ceramic
R109	0 Ω	1/4W	C204	102	Ceramic
R110	1k Ω	1/4W	C222	222/1kV	Ceramic
R111	6k Ω	1/4W	MOSFET		
R113	180k Ω	1/4W	Q101	FQPF8N60C	Fairchild
R114	50k Ω	1/4W	Diode		
R201	1.5k Ω	1/4W	D101, D102	UF4007	Fairchild
R202	1.2k Ω	1/4W	D103	1N5819	Fairchild
R203	20k Ω	1/4W	D202, D204	FYPF2010DN	Fairchild
R204	27k Ω	1/4W	ZD101, ZD201	1N4744	Fairchild
R205	7k Ω	1/4W	BD101	KBP06	Fairchild
R206	10 Ω	1/2W	TNR		
R207	10k Ω	1/4W	R101	471	470V
IC			Filter		
IC101	FAN7602	Fairchild	LF101	23mH	0.8A
IC201	KA431	Fairchild	L201	10 μ H	4.2A
OP1, OP2	H11A817B	Fairchild			

7. PCB Layout

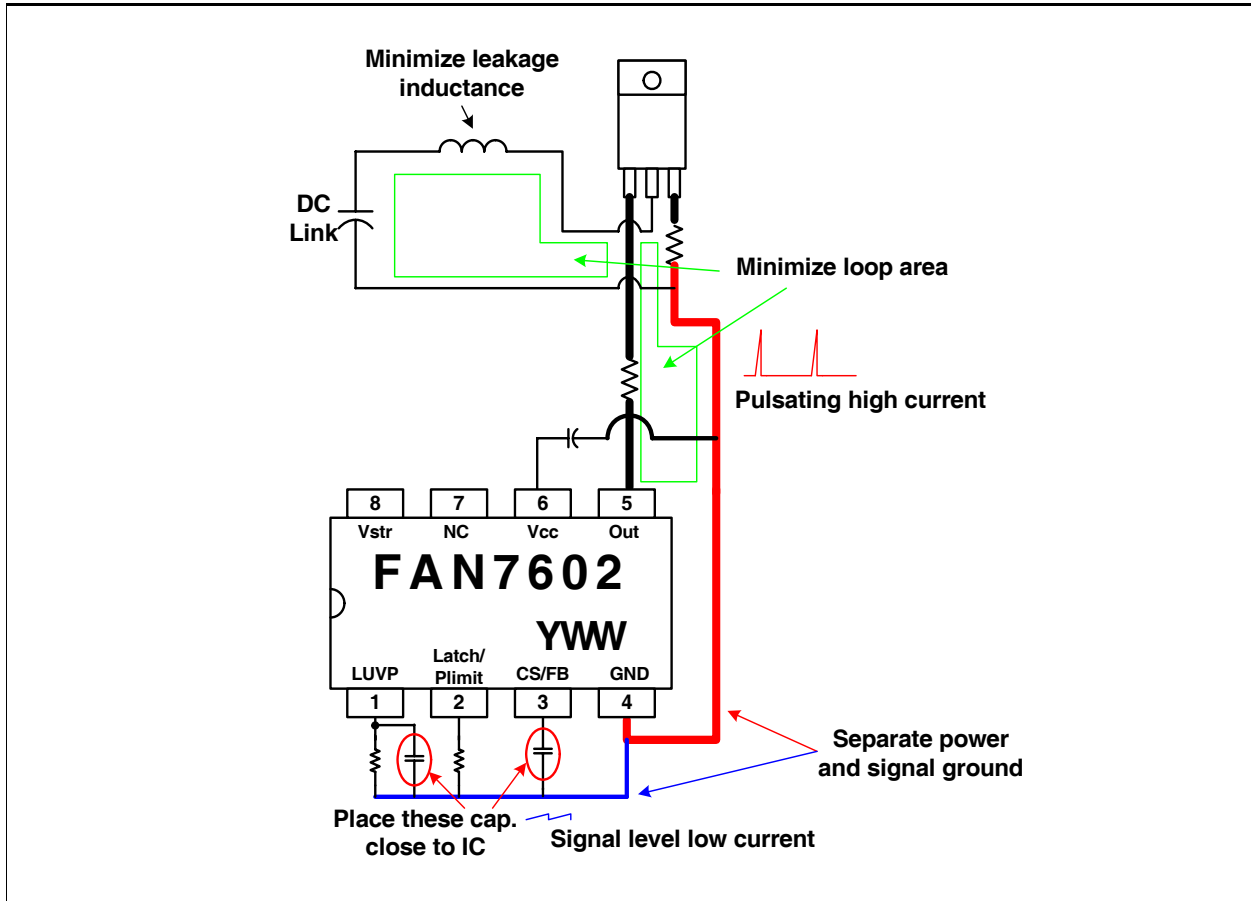

Figure 28. PCB Layout Recommendations for FAN7602

8. Performance Data

	85Vac	110Vac	220Vac	265Vac
Input Power at No Load	105.4mW	119.8mW	184.7mW	205.5mW
Input Power at 0.5W Load	739.4mW	761.4mW	825.4mW	872.2mW
OLP Point	4.42A	4.66A	4.6A	4.4A

Mechanical Dimensions

Package

Dimensions in inch (millimeters)

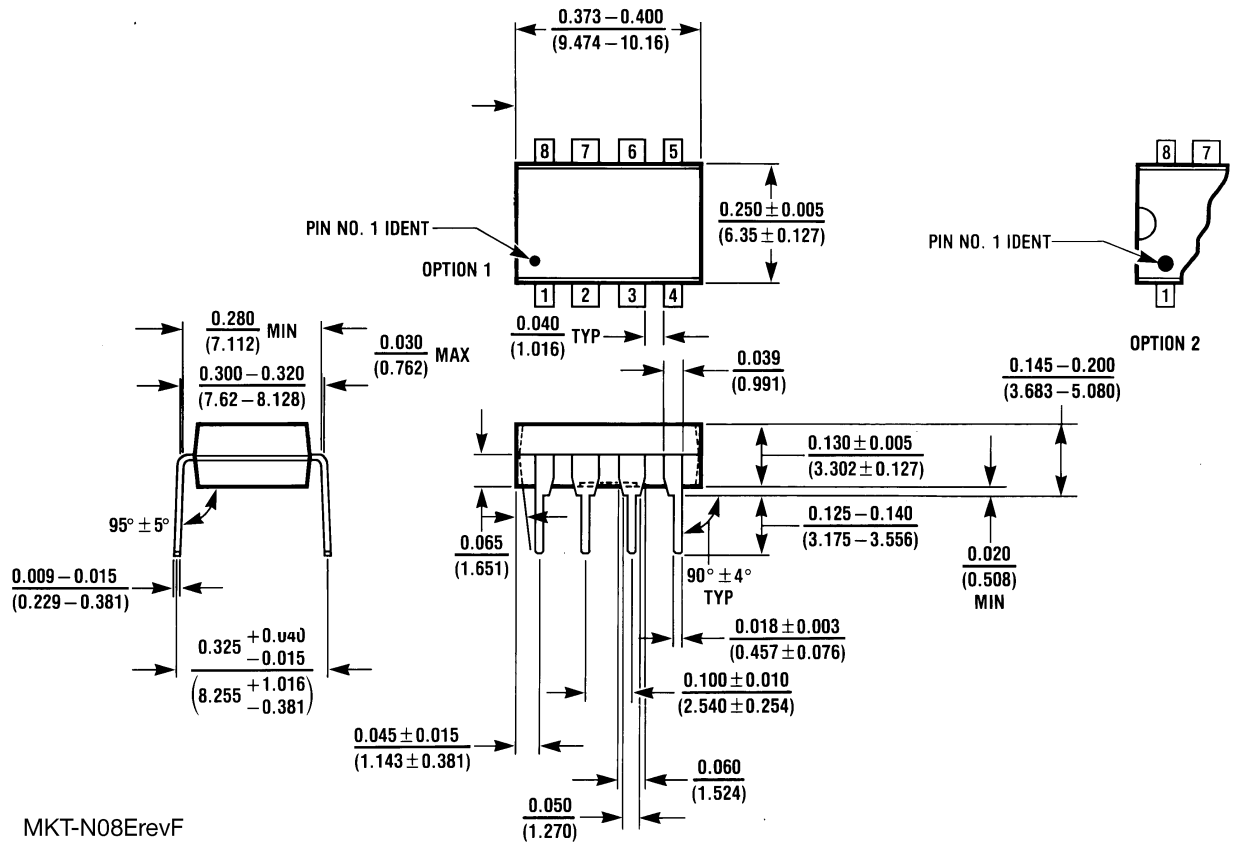

MKT-N08ErevF

TRADEMARKS

The following are registered and unregistered trademarks Fairchild Semiconductor owns or is authorized to use and is not intended to be an exhaustive list of all such trademarks.

ACEx™	FAST®	ISOPLANAR™	PowerEdge™	SuperFET™
ActiveArray™	FASTr™	LittleFET™	PowerSaver™	SuperSOT™-3
Bottomless™	FPS™	MICROCOUPLER™	PowerTrench®	SuperSOT™-6
Build it Now™	FRFET™	MicroFET™	QFET®	SuperSOT™-8
CoolFET™	GlobalOptoisolator™	MicroPak™	QST™	SyncFET™
CROSSVOLT™	GTO™	MICROWIRE™	QT Optoelectronics™	TCM™
DOME™	HiSeC™	MSX™	Quiet Series™	TinyLogic®
EcoSPARK™	I ² C™	MSXPro™	RapidConfigure™	TINYOPTO™
E ² CMOS™	i-Lo™	OCX™	RapidConnect™	TruTranslation™
EnSigna™	ImpliedDisconnect™	OCXPro™	μSerDes™	UHC™
FACT™	IntelliMAX™	OPTOLOGIC®	ScalarPump™	UniFET™
FACT Quiet Series™		OPTOPLANAR™	SILENT SWITCHER®	UltraFET®
Across the board. Around the world.™		PACMAN™	SMART START™	VCX™
The Power Franchise®		POP™	SPM™	Wire™
Programmable Active Droop™		Power247™	Stealth™	

DISCLAIMER

FAIRCHILD SEMICONDUCTOR RESERVES THE RIGHT TO MAKE CHANGES WITHOUT FURTHER NOTICE TO ANY PRODUCTS HEREIN TO IMPROVE RELIABILITY, FUNCTION OR DESIGN. FAIRCHILD DOES NOT ASSUME ANY LIABILITY ARISING OUT OF THE APPLICATION OR USE OF ANY PRODUCT OR CIRCUIT DESCRIBED HEREIN; NEITHER DOES IT CONVEY ANY LICENSE UNDER ITS PATENT RIGHTS, NOR THE RIGHTS OF OTHERS. THESE SPECIFICATIONS DO NOT EXPAND THE TERMS OF FAIRCHILD'S WORLDWIDE TERMS AND CONDITIONS, SPECIFICALLY THE WARRANTY THEREIN, WHICH COVERS THESE PRODUCTS.

LIFE SUPPORT POLICY

FAIRCHILD'S PRODUCTS ARE NOT AUTHORIZED FOR USE AS CRITICAL COMPONENTS IN LIFE SUPPORT DEVICES OR SYSTEMS WITHOUT THE EXPRESS WRITTEN APPROVAL OF FAIRCHILD SEMICONDUCTOR CORPORATION.

As used herein:

1. Life support devices or systems are devices or systems which, (a) are intended for surgical implant into the body, or (b) support or sustain life, or (c) whose failure to perform when properly used in accordance with instructions for use provided in the labeling, can be reasonably expected to result in significant injury to the user.
2. A critical component is any component of a life support device or system whose failure to perform can be reasonably expected to cause the failure of the life support device or system, or to affect its safety or effectiveness.

PRODUCT STATUS DEFINITIONS

Definition of Terms

Datasheet Identification	Product Status	Definition
Advance Information	Formative or In Design	This datasheet contains the design specifications for product development. Specifications may change in any manner without notice.
Preliminary	First Production	This datasheet contains preliminary data, and supplementary data will be published at a later date. Fairchild Semiconductor reserves the right to make changes at any time without notice in order to improve design.
No Identification Needed	Full Production	This datasheet contains final specifications. Fairchild Semiconductor reserves the right to make changes at any time without notice in order to improve design.
Obsolete	Not In Production	This datasheet contains specifications on a product that has been discontinued by Fairchild semiconductor. The datasheet is printed for reference information only.

Rev. 119