

FA38SA50LC

HEXFET® Power MOSFET

- Fully Isolated Package
- Easy to Use and Parallel
- Low On-Resistance
- Dynamic dv/dt Rating
- Fully Avalanche Rated
- Simple Drive Requirements
- Low Drain to Case Capacitance
- Low Internal Inductance

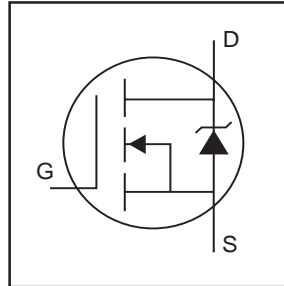

$V_{DSS} = 500V$
$R_{DS(on)} = 0.13\Omega$
$I_D = 38A$

Description

Third Generation HEXFETs from International Rectifier provide the designer with the best combination of fast switching, ruggedized device design, low on-resistance and cost-effectiveness.

The SOT-227 package is universally preferred for all commercial-industrial applications at power dissipation levels to approximately 500 watts. The low thermal resistance of the SOT-227 contribute to its wide acceptance throughout the industry.

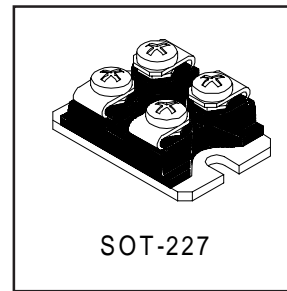

Absolute Maximum Ratings

	Parameter	Max.	Units
$I_D @ T_C = 25^\circ C$	Continuous Drain Current, $V_{GS} @ 10V$	38	A
$I_D @ T_C = 100^\circ C$	Continuous Drain Current, $V_{GS} @ 10V$	24	
I_{DM}	Pulsed Drain Current ①	150	
$P_D @ T_C = 25^\circ C$	Power Dissipation	500	W
	Linear Derating Factor	4.0	W/°C
V_{GS}	Gate-to-Source Voltage	± 20	V
E_{AS}	Single Pulse Avalanche Energy②	580	mJ
I_{AR}	Avalanche Current①	38	A
E_{AR}	Repetitive Avalanche Energy①	50	mJ
dv/dt	Peak Diode Recovery dv/dt ③	16	V/ns
T_J	Operating Junction and	-55 to + 150	°C
T_{STG}	Storage Temperature Range		
V_{ISO}	Insulation Withstand Voltage (AC-RMS)	2.5	kV
	Mounting torque, M4 screw	(1.3N•M)	

Thermal Resistance

	Parameter	Typ.	Max.	Units
$R_{\theta JC}$	Junction-to-Case	—	0.25	°C/W
$R_{\theta CS}$	Case-to-Sink, Flat, Greased Surface	0.05	—	

FA38SA50LC



Electrical Characteristics @ $T_J = 25^\circ\text{C}$ (unless otherwise specified)

	Parameter	Min.	Typ.	Max.	Units	Conditions
$V_{(BR)DSS}$	Drain-to-Source Breakdown Voltage	500	—	—	V	$V_{GS} = 0V, I_D = 1.0mA$
$\Delta V_{(BR)DSS}/\Delta T_J$	Breakdown Voltage Temp. Coefficient	—	0.66	—	$V/^\circ\text{C}$	Reference to $25^\circ\text{C}, I_D = 1mA$
$R_{DS(on)}$	Static Drain-to-Source On-Resistance	—	—	0.13	Ω	$V_{GS} = 10V, I_D = 23A$ ④
$V_{GS(th)}$	Gate Threshold Voltage	2.0	—	4.0	V	$V_{DS} = V_{GS}, I_D = 250\mu A$
g_{fs}	Forward Transconductance	22	—	—	S	$V_{DS} = 25V, I_D = 23A$
I_{DSS}	Drain-to-Source Leakage Current	—	—	50	μA	$V_{DS} = 500V, V_{GS} = 0V$
		—	—	500		$V_{DS} = 400V, V_{GS} = 0V, T_J = 125^\circ\text{C}$
I_{GSS}	Gate-to-Source Forward Leakage	—	—	200	nA	$V_{GS} = 20V$
	Gate-to-Source Reverse Leakage	—	—	-200		$V_{GS} = -20V$
Q_g	Total Gate Charge	—	280	420	nC	$I_D = 38A$
Q_{gs}	Gate-to-Source Charge	—	37	55		$V_{DS} = 400V$
Q_{gd}	Gate-to-Drain ("Miller") Charge	—	150	220		$V_{GS} = 10V, \text{ See Fig. 6 and 13 } ④$
$t_{d(on)}$	Turn-On Delay Time	—	42	—	ns	$V_{DD} = 250V$
t_r	Rise Time	—	340	—		$I_D = 38A$
$t_{d(off)}$	Turn-Off Delay Time	—	200	—		$R_G = 10\Omega$ (Internal)
t_f	Fall Time	—	330	—		$R_D = 8\Omega, \text{ See Fig. 10 } ④$
L_s	Internal Source Inductance	—	5.0	—	nH	Between lead, and center of die contact
C_{iss}	Input Capacitance	—	6900	—	pF	$V_{GS} = 0V$
C_{oss}	Output Capacitance	—	1600	—		$V_{DS} = 25V$
C_{rss}	Reverse Transfer Capacitance	—	580	—		$f = 1.0MHz, \text{ See Fig. 5}$

Source-Drain Ratings and Characteristics

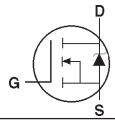
	Parameter	Min.	Typ.	Max.	Units	Conditions
I_S	Continuous Source Current (Body Diode)	—	—	38	A	MOSFET symbol showing the integral reverse p-n junction diode. 
I_{SM}	Pulsed Source Current (Body Diode) ①	—	—	150		
V_{SD}	Diode Forward Voltage	—	—	1.3	V	$T_J = 25^\circ\text{C}, I_S = 38A, V_{GS} = 0V$ ④
t_{rr}	Reverse Recovery Time	—	830	1300	ns	$T_J = 25^\circ\text{C}, I_F = 38A$
Q_{rr}	Reverse Recovery Charge	—	15	22	μC	$di/dt = 100A/\mu s$ ④
t_{on}	Forward Turn-On Time	Intrinsic turn-on time is negligible (turn-on is dominated by L_S+L_D)				

Notes:

- ① Repetitive rating; pulse width limited by max. junction temperature. (See fig. 11)
- ② Starting $T_J = 25^\circ\text{C}, L = 0.80mH$
 $R_G = 25\Omega, I_{AS} = 38A.$ (See Figure 12)
- ③ $I_{SD} \leq 38A, di/dt \leq 410A/\mu s, V_{DD} \leq V_{(BR)DSS}, T_J \leq 150^\circ\text{C}$
- ④ Pulse width $\leq 300\mu s$; duty cycle $\leq 2\%$.



FA38SA50LC

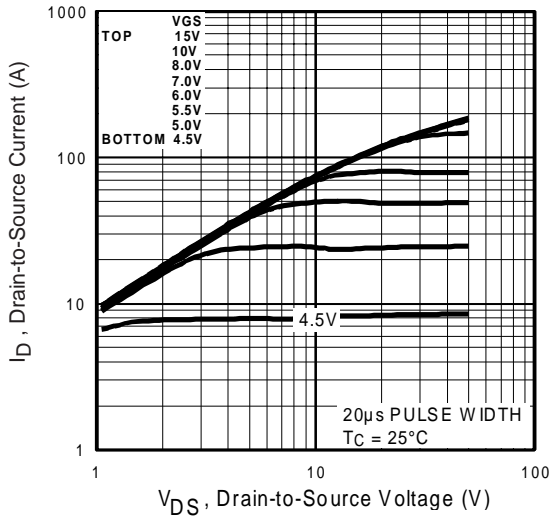

Fig 1. Typical Output Characteristics

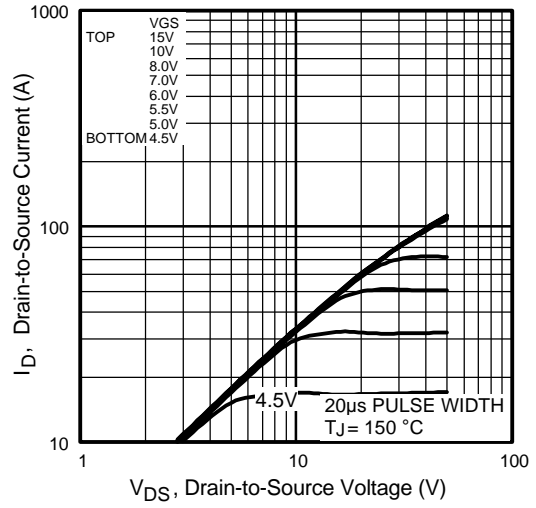

Fig 2. Typical Output Characteristics

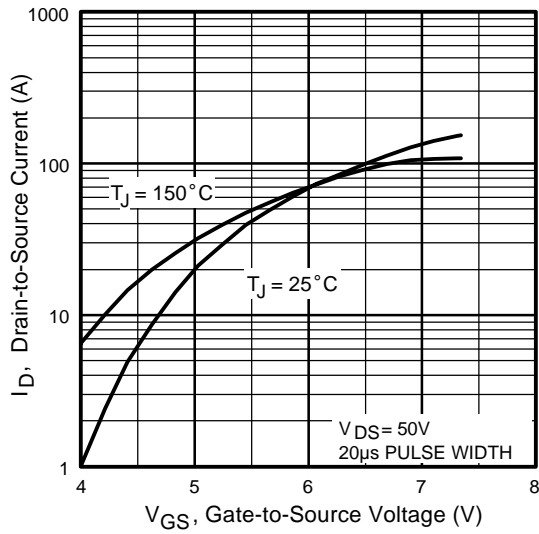

Fig 3. Typical Transfer Characteristics

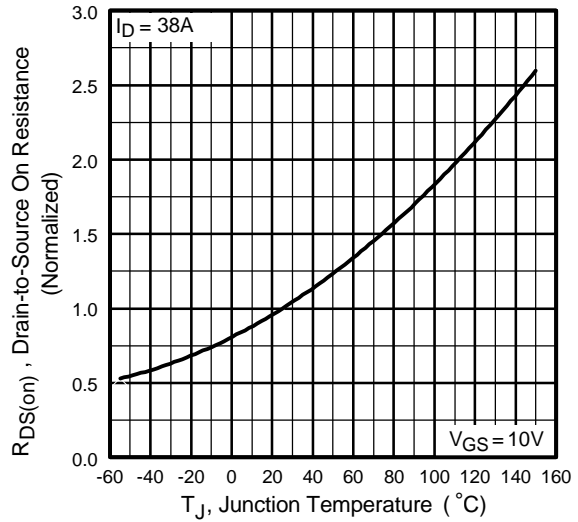

Fig 4. Normalized On-Resistance Vs. Temperature

FA38SA50LC

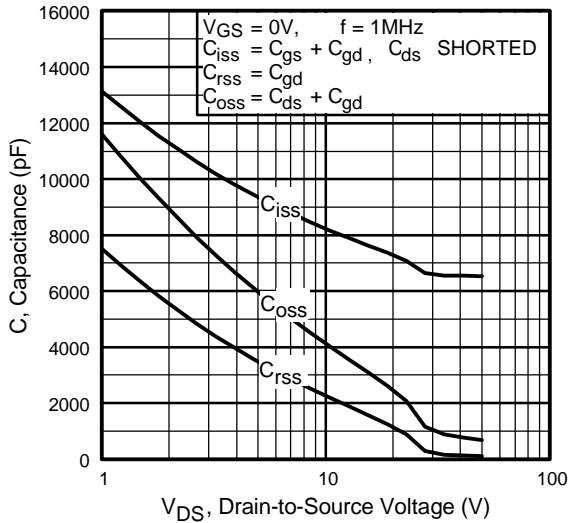

Fig 5. Typical Capacitance Vs. Drain-to-Source Voltage

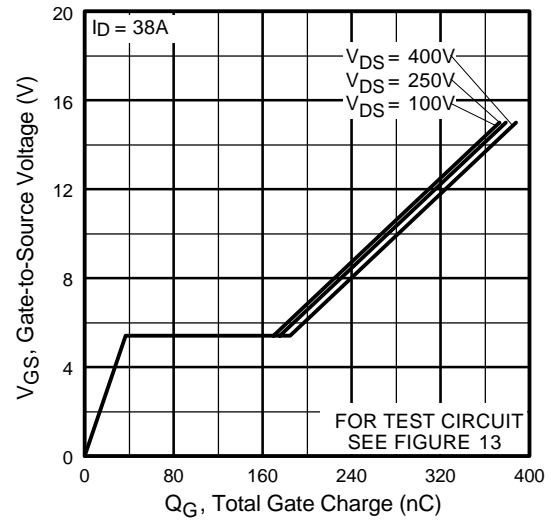

Fig 6. Typical Gate Charge Vs. Gate-to-Source Voltage

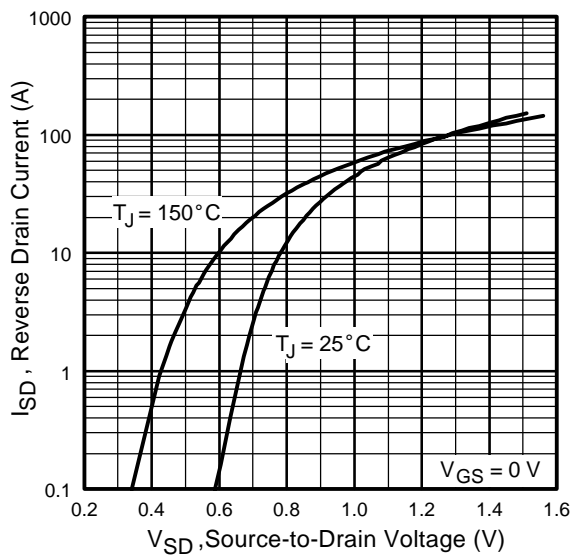

Fig 7. Typical Source-Drain Diode Forward Voltage

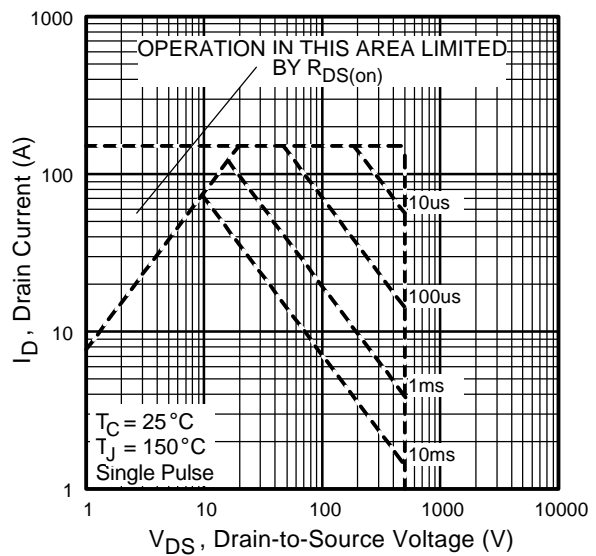

Fig 8. Maximum Safe Operating Area



FA38SA50LC

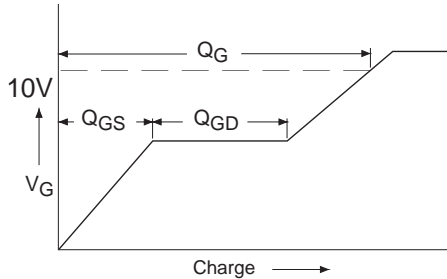

Fig 9a. Basic Gate Charge Waveform

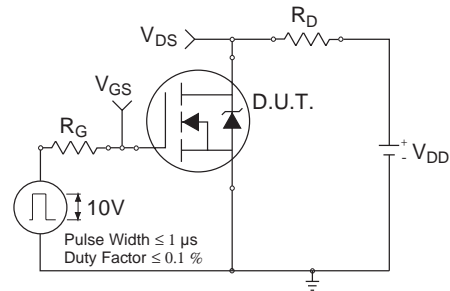

Fig 10a. Switching Time Test Circuit

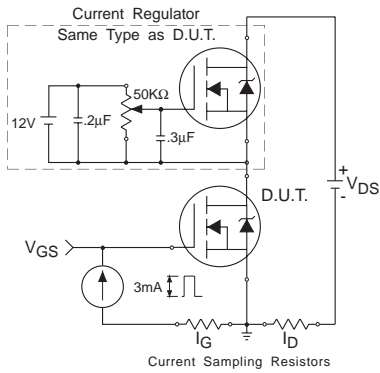

Fig 9b. Gate Charge Test Circuit

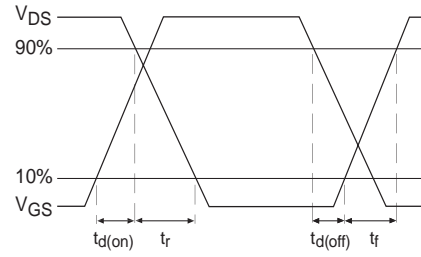

Fig 10b. Switching Time Waveforms

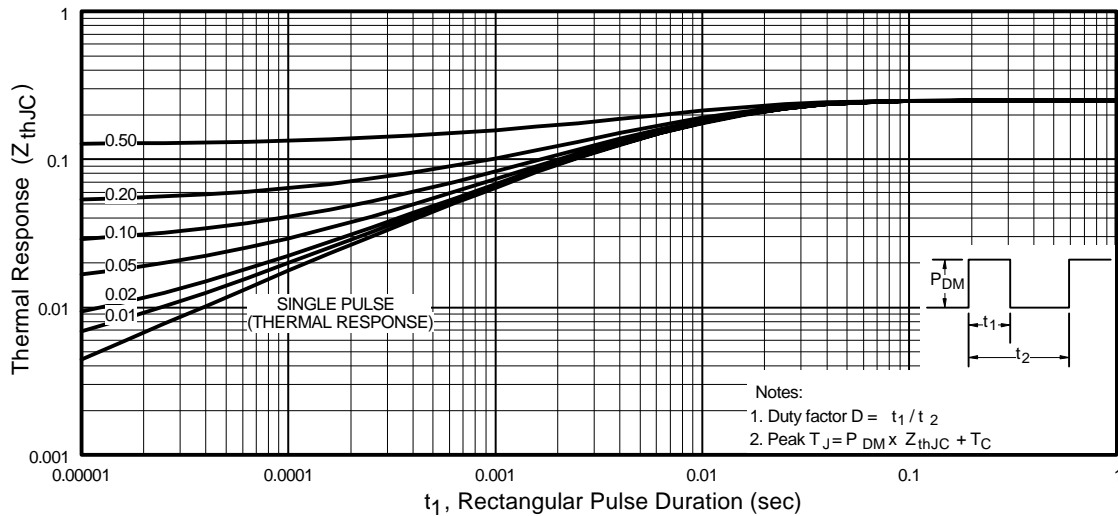

Fig 11. Maximum Effective Transient Thermal Impedance, Junction-to-Case

FA38SA50LC

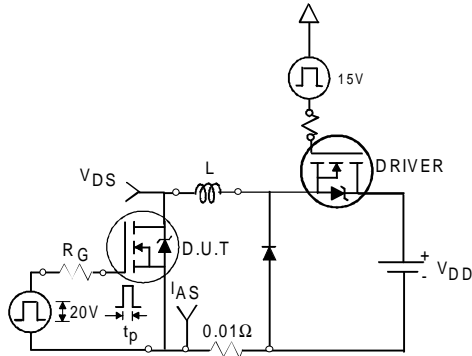

Fig 12a. Unclamped Inductive Test Circuit

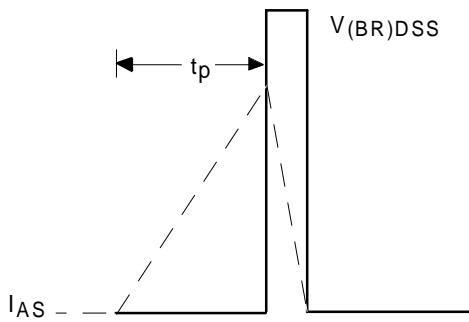

Fig 12b. Unclamped Inductive Waveforms

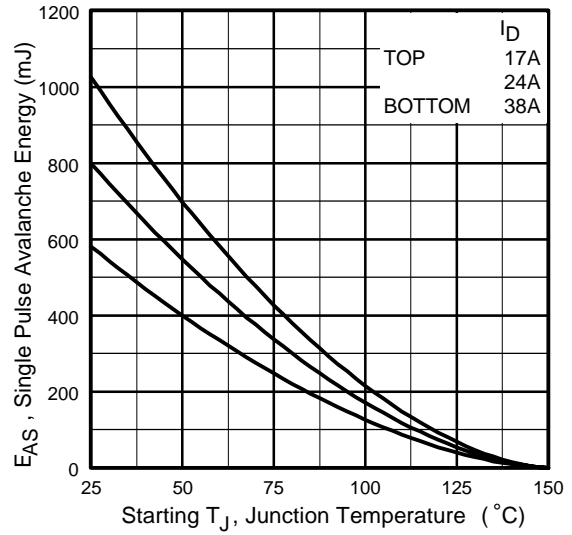
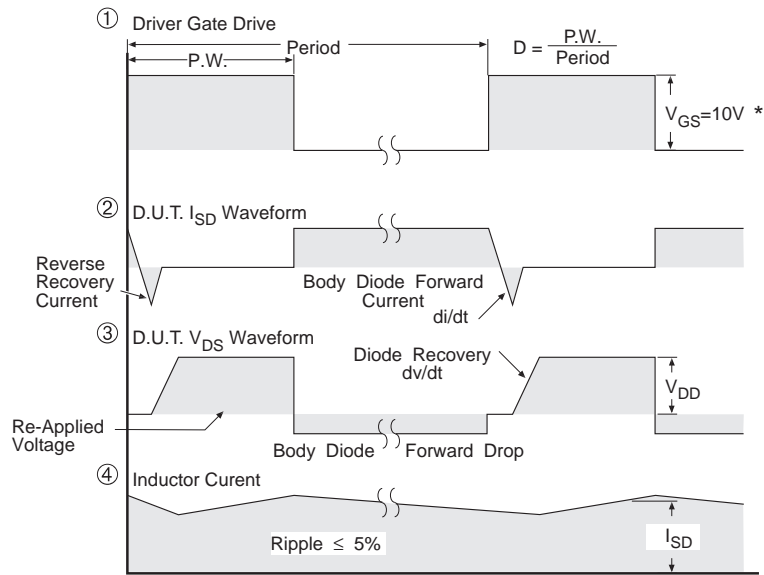
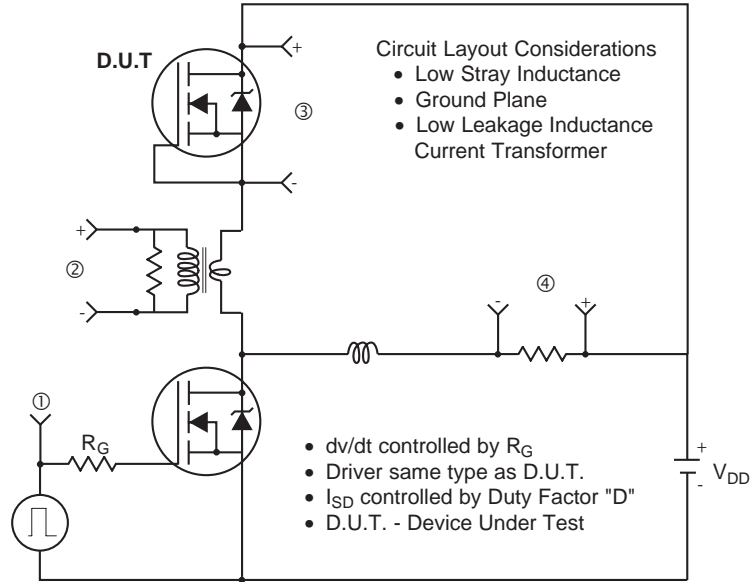

Fig 12c. Maximum Avalanche Energy Vs. Drain Current

Peak Diode Recovery dv/dt Test Circuit



* $V_{GS} = 5V$ for Logic Level Devices

Fig 13. For N-Channel HEXFETS

FA38SA50LC



SOT-227 Package Details

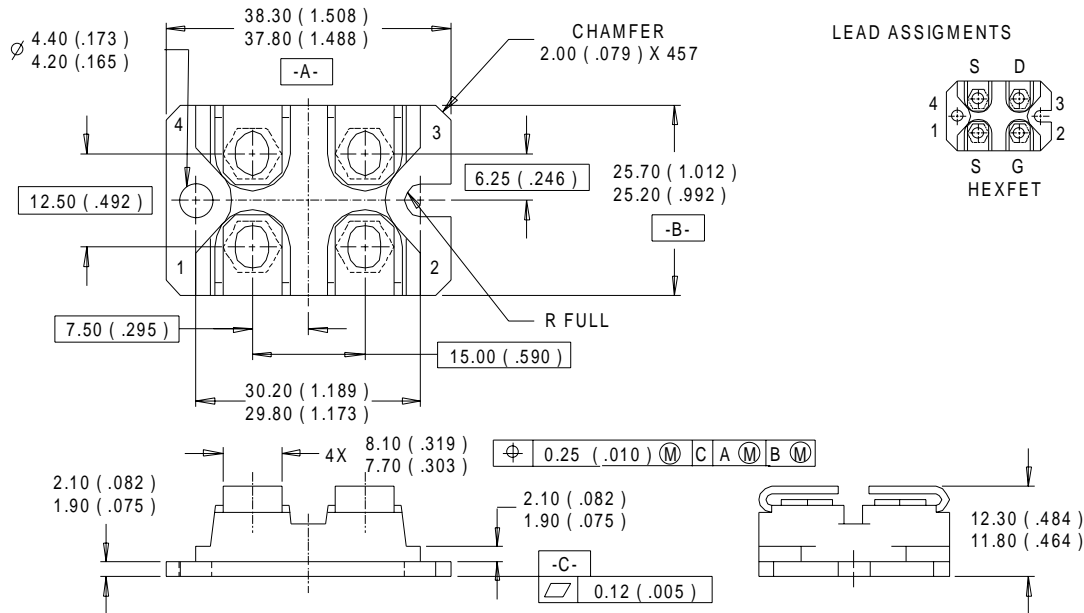

Tube

QUANTITY PER TUBE IS 10
M4 SREW AND WASHER INCLUDED

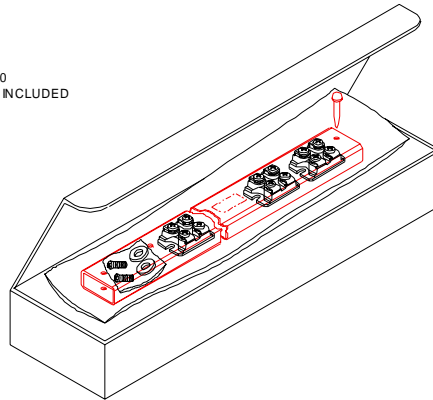

International
IOR Rectifier

WORLD HEADQUARTERS: 233 Kansas St., El Segundo, California 90245, Tel: (310) 322 3331

IR GREAT BRITAIN: Hurst Green, Oxted, Surrey RH8 9BB, UK Tel: ++ 44 1883 732020

IR CANADA: 15 Lincoln Court, Brampton, Ontario L6T3Z2, Tel: (905) 453 2200

IR GERMANY: Saalburgstrasse 157, 61350 Bad Homburg Tel: ++ 49 6172 96590

IR ITALY: Via Liguria 49, 10071 Borgaro, Torino Tel: ++ 39 11 451 0111

IR FAR EAST: K&H Bldg., 2F, 30-4 Nishi-Ikebukuro 3-Chome, Toshima-Ku, Tokyo Japan 171 Tel: 81 3 3983 0086

IR SOUTHEAST ASIA: 1 Kim Seng Promenade, Great World City West Tower, 13-11, Singapore 237994 Tel: ++ 65 838 4630

IR TAIWAN: 16 Fl. Suite D. 207, Sec. 2, Tun Haw South Road, Taipei, 10673, Taiwan Tel: 886-2-2377-9936

<http://www.irf.com/> Data and specifications subject to change without notice. 2/99