

FEATURES

- 3% EVM @ $P_{OUT} = +20$ dBm with IEEE 802.11g 64 QAM Modulation at 54 Mbps
- -38 dBc ACPR 1st Sidelobe at +23 dBm with IEEE 802.11b at 1, 2, 5.5, 11 Mbps
- -54 dBc ACPR 2nd Sidelobe at +23 dBm with IEEE 802.11b at 1, 2, 5.5, 11 Mbps
- Single +3.3 V Supply
- 32 dB of Linear Power Gain
- Temperature-Compensated Linear Power Detector
- 3 mm x 3 mm x 0.9 mm LPCC
- RoHS Compliant
- 50Ω - Matched RF Ports

APPLICATIONS

- 802.11b/g WLAN
- 2.4 GHz ISM Equipment

PRODUCT DESCRIPTION

The ANADIGICS AWL9224 power amplifier is a high performance InGaP HBT IC designed for transmit applications in the 2.4-2.5 GHz band. Matched to 50Ω at the input and output, the part requires no additional RF matching components off-chip. The PA exhibits unparalleled linearity for both IEEE 802.11g and 802.11b WLAN systems under the toughest signal configurations within these standards.

The power detector is temperature compensated on the chip, enabling a single-ended output voltage with excellent accuracy over a wide range of operating temperatures. The PA is biased by a single +3.3 V supply and consumes ultra-low current in the OFF mode.

The AWL9224 is manufactured using advanced InGaP HBT technology that offers state-of-the-art reliability, temperature stability and ruggedness. The AWL9224 is RoHS (Restrictions on Hazardous Substances) compliant. It is provided in a 3 x 3 x 0.9 mm LPCC package optimized for a 50Ω system.

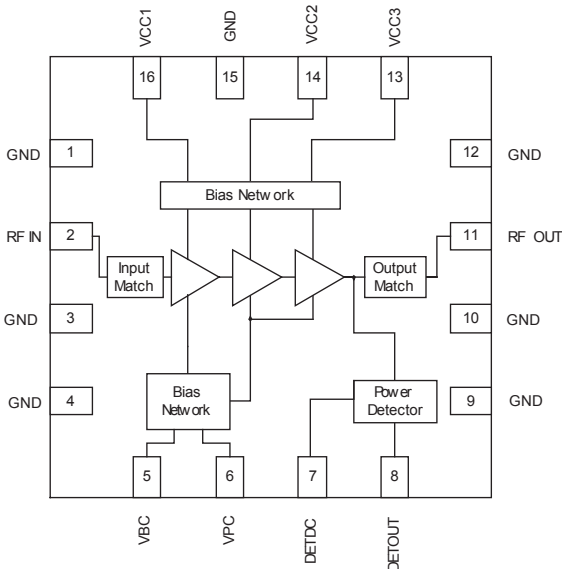
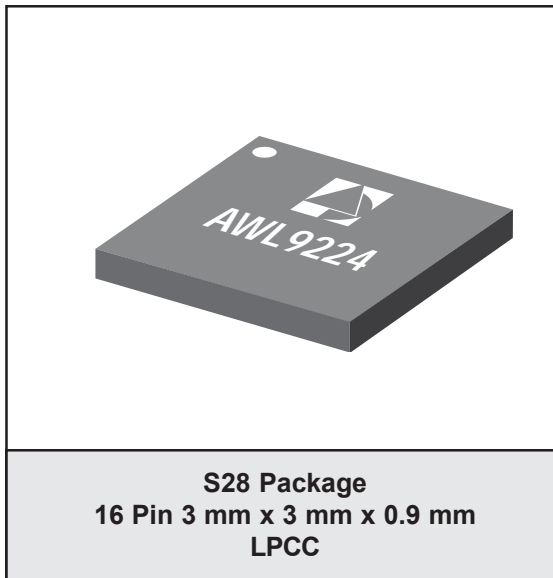

Figure 1: Block Diagram and Pinout

Table 1: Pin Description

PIN	NAME	DESCRIPTION
1	GND	Ground. Connect directly to PCB ground pattern under Pin 25 using short trace.
2	RF _{IN}	RF Input. AC coupled input stage internally matched to 50 Ohms. Route as coplanar waveguide using adjacent ground pins.
3	GND	Ground. Connect directly to PCB ground pattern under Pin 25 using short trace.
4	GND	Ground. Connect directly to PCB ground pattern under Pin 25 using short trace.
5	V _{BC}	Bias Circuit Voltage. Supply voltage and current is applied to this pin to apply power to the bias circuits inside the PA.
6	V _{PC}	Power amplifier power control pin. The recommended use is for on/off control of the PA. Nominally, 0 V applied will turn amplifier completely off; +3.3 V should be used to set amplifier to maximum output capability. A series resistor is used to set the current flow into the pin, thereby controlling the overall bias level of the PA.
7	DET _{DC}	Detector Bias. Supply voltage and current is applied to this pin to apply power to the detector circuits inside the PA.
8	DET _{OUT}	Power Detector Output. DC coupled. An emitter follower BJT supplies the output for this pin.
9	GND	Ground. Connect directly to PCB ground pattern under Pin 25 using short trace.
10	GND	Ground. Connect directly to PCB ground pattern under Pin 25 using short trace.
11	RF _{OUT}	RF Output. AC coupled output stage internally matched to 50 Ohms. Route as coplanar waveguide using adjacent ground pins. A shunt inductive matching element included inside the PA after the AC coupling capacitor provides a DC path to ground at this pin.
12	GND	Ground. Connect directly to PCB ground pattern under Pin 25 using short trace.
13	V _{CC3}	Supply Voltage. Bias for power transistor of stage 3.
14	V _{CC2}	Supply Voltage. Bias for power transistor of stage 2.
15	GND	Ground. Connect directly to PCB ground pattern under Pin 25 using short trace.
16	V _{CC1}	Supply Voltage. Bias for power transistor of stage 1.
25	GND	Ground slug on the underside of the LPCC package.

ELECTRICAL CHARACTERISTICS

Table 2: Absolute Minimum and Maximum Ratings

PARAMETER	MIN	MAX	UNIT	COMMENTS
DC Power Supply ($V_{CC1}, V_{CC2}, V_{CC3}$)	-	+4.5	V	
Power Control Level (V_{PC})	-	+4.5	V	Applied to series resistors external to V_{PC} pin. No RF signal applied.
Bias Control (V_{BC})	-	+4.5	V	No RF signal applied
DC Current Consumption	-	700	mA	
RF Input Level (RF_{IN})	-	-5	dBm	
Operating Ambient Temperature	-40	+85	°C	
Storage Temperature	-55	+150	°C	

Stresses in excess of the absolute ratings may cause permanent damage. Functional operation is not implied under these conditions. Exposure to absolute ratings for extended periods of time may adversely affect reliability.

Table 3: Operating Ranges

PARAMETER	MIN	TYP	MAX	UNIT	COMMENTS
Operating Frequency (f)	2400	-	2500	MHz	
Supply Voltage ($V_{CC1}, V_{CC2}, V_{CC3}$)	+3.0	+3.3	+3.6	V	
Bias Voltage (V_{BC})	+3.0	+3.3	+3.6	V	
Power Control Voltage (V_{PC})	+2.8 0	+3.3 -	+3.6 +0.5	V	PA "ON" ⁽¹⁾ PA "SHUTDOWN" ⁽¹⁾
Case Temperature (T_C)	-40	-	+85	°C	

The device may be operated safely over these conditions; however, parametric performance is guaranteed only over the conditions defined in the electrical specifications.

Note:

(1) Applied to series resistors external to V_{PC} pin.

Table 4: Electrical Specifications - Continuous Wave
(T_c = +25 °C, V_{CC} = +3.3 V, V_{PC} = +3.3 V)

PARAMETER	MIN	TYP	MAX	UNIT	COMMENTS
P1dB	26.0	27.0	28.0	dBm	
Shutdown Current	-	-	1	μA	V _{PC} = 0 V
Quiescent Current	67	75	83	mA	V _{PC} = +3.3 V, V _{CC} = +3.3 V RF = off
Input Return Loss	-	-10	-8	dB	
Output Return Loss	-	-12	-10	dB	
Reverse Isolation	40	-	-	dB	
Stability (Spurious)	-	-70	-65	dBc	5:1 VSWR at P _{IN} = -10 dBm
T _{ON} Setting Time	-	-	1	μS	Settles within ±0.5 dB
T _{OFF} Setting Time	-	-	1	μS	

Table 5: Electrical Specifications - IEEE 802.11g
(T_C = +25 °C, V_{CC} = +3.3 V, V_{PC} = +3.3 V, 64 QAM OFDM 54Mbps)

PARAMETER	MIN	TYP	MAX	UNIT	COMMENTS
Operating Frequency	2400	-	2500	MHz	
Power Gain	29.9	32.0	33.5	dB	
Gain Ripple	-	± 0.5	-	dB	Across 100 MHz band
Error Vector Magnitude (EVM) ⁽¹⁾	- -	3.0 -30.5	4.2 -27.5	% dB	802.11g 54 Mbps data rate P _{OUT} = +20 dBm
Current Consumption	185	200	215	mA	P _{OUT} = +20 dBm
Harmonics 2fo 3fo	- -	-40 -40	-35 -35	dBc	P _{OUT} = +20 dBm
Power Detector Voltage	0.80	0.85	0.90	V	P _{OUT} = +20 dBm
Power Detector Sensitivity	55	65	75	mV/dB	10 dBm < P _{OUT} < 23 dBm
Power Detector Output Load Impedance	1	-	-	kΩ	

Note:

(1) EVM includes system noise floor of 1% (-40 dB).

Table 6: Electrical Specifications - IEEE 802.11b
 (T_c = +25 °C, V_{CC} = +3.3 V, V_{PC} = +3.3 V, 1 Mbps, Gaussian Baseband Filtering, BT = 0.45)

PARAMETER	MIN	TYP	MAX	UNIT	COMMENTS
Operating Frequency	2400	-	2500	MHz	
Power Gain	31.0	33.0	34.5	dB	
Gain Ripple	-	±0.5	-	dB	Across 100 MHz band
Adjacent Channel Power (ACPR) 1st Sidelobe (± 11 MHz offset)	-	-40	-35	dBc	1 Mbps, Gaussian Baseband Filtering; P _{OUT} = +23 dBm
Adjacent Channel Power (ACPR) 2nd Sidelobe (± 22 MHz offset)	-	-55	-53	dBc	1 Mbps, Gaussian Baseband Filtering; P _{OUT} = +23 dBm
Current Consumption	-	190	200	mA	P _{OUT} = +19 dBm
	-	225	240		P _{OUT} = +21 dBm
	-	275	295		P _{OUT} = +23 dBm
Harmonics 2fo 3fo	-	-33	-30	dBc	P _{OUT} = +23 dBm
	-	-40	-35		
Power Detector Voltage	1.00	1.05	1.10	V	P _{OUT} = +23 dBm
Power Detector Sensitivity	50	65	80	mV/dB	10 dBm < P _{OUT} < 23 dBm
Power Detector Output Load Impedance	1	-	-	kΩ	

PERFORMANCE DATA

Figure 2: Gain vs. Output Power Across Frequency ($V_{CC} = +3.3V$, $T_C = +25^\circ C$)
802.11g 54 Mbps OFDM

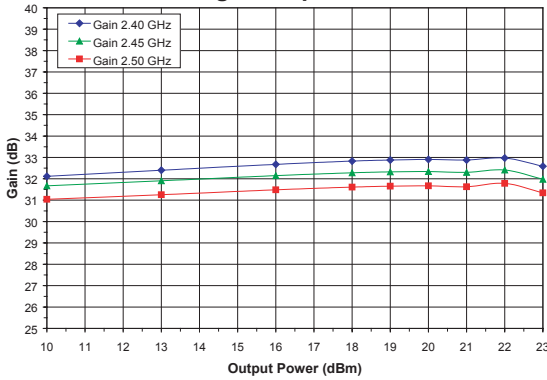

Figure 3: I_{CC} and EVM vs. Output Power Across Frequency ($V_{CC} = +3.3V$, $T_C = 25^\circ C$)
802.11g 54 Mbps OFDM

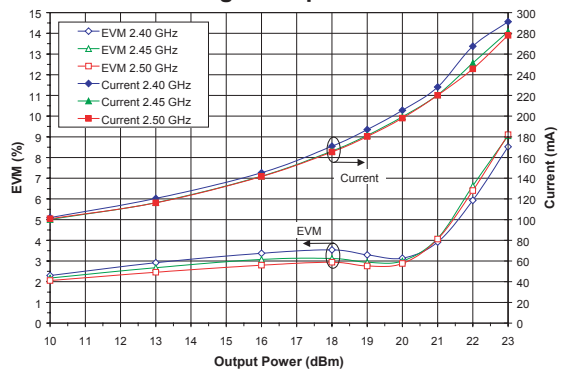

Figure 4: Gain vs. Output Power Across Temp. (Frequency = 2.45GHz, $V_{CC} = +3.3V$)
802.11g 54 Mbps OFDM

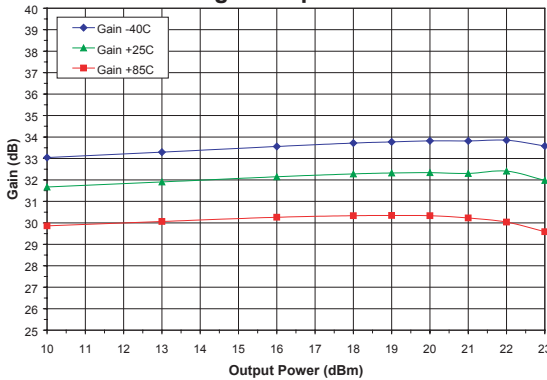

Figure 5: I_{CC} and EVM vs. Output Power Across Temp. (Frequency = 2.45GHz, $V_{CC} = +3.3V$)
802.11g 54 Mbps OFDM

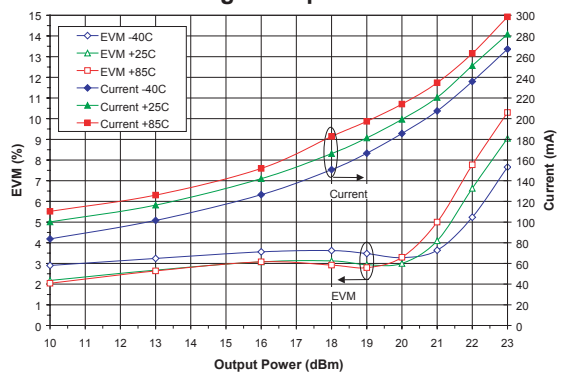

Figure 6: Gain vs. Output Power Across Power Supply Voltage (Frequency = 2.45GHz, $T_C = 25^\circ C$)
802.11g 54 Mbps OFDM

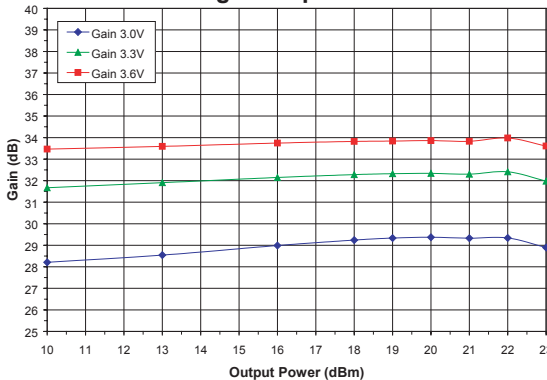

Figure 7: I_{CC} and EVM vs. Output Power Across Power Supply Voltage (Freq = 2.45GHz, $T_C = 25^\circ C$)
802.11g 54 Mbps OFDM

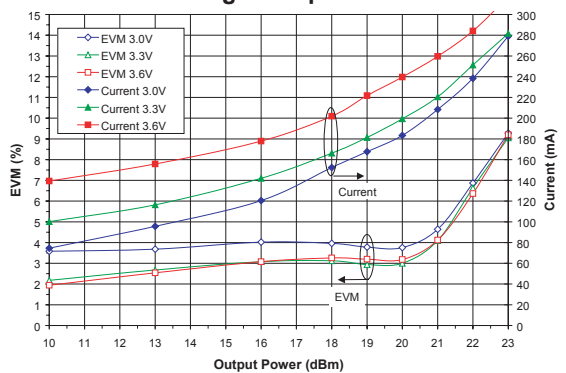
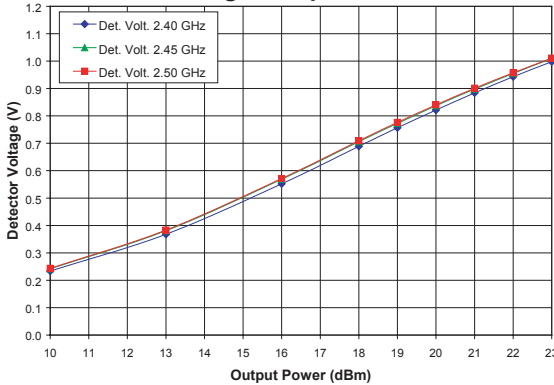

Figure 8: Detector Voltage vs. Output Power Across Frequency (T_c = 25°C, V_{cc} = +3.3V) 802.11g 54 Mbps OFDM



Note: Results at 2.50GHz Obscure the Results at 2.45GHz

Figure 9: Detector Voltage vs. Output Power Across Temp. (Freq = 2.45 GHz, V_{cc} = +3.3V) 802.11g 54 Mbps OFDM

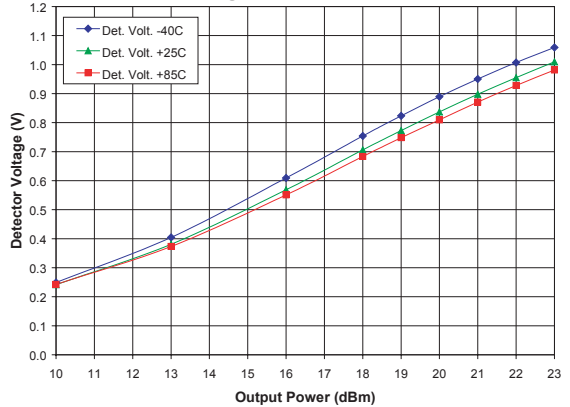

Figure 10: Gain and I_{cc} vs. Output Power Across Frequency (V_{cc} = +3.3V, T_c = 25°C) 802.11b Gaussian Filtering (BT = 0.45), 1 Mbps

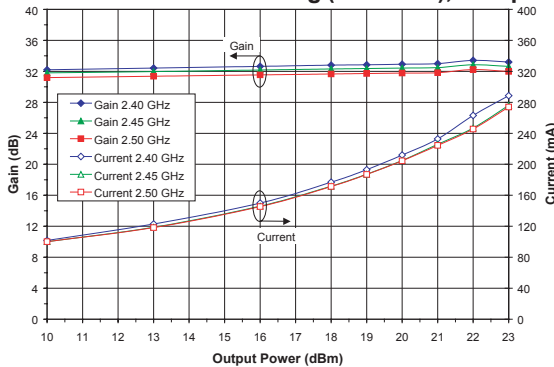

Figure 11: Gain and I_{cc} vs. Output Power Across Temp. (Frequency = 2.45GHz, V_{cc} = +3.3V) 802.11b Gaussian Filtering (BT = 0.45), 1 Mbps

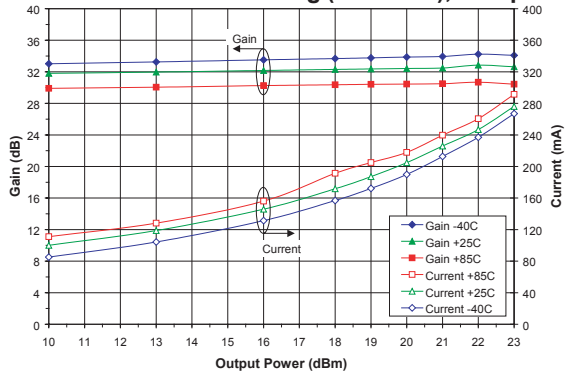

Figure 12: Gain and I_{cc} vs. Output Power Across Power Supply Voltage (Freq = 2.45GHz, T_c = 25°C) 802.11b Gaussian Filtering (BT = 0.45), 1 Mbps

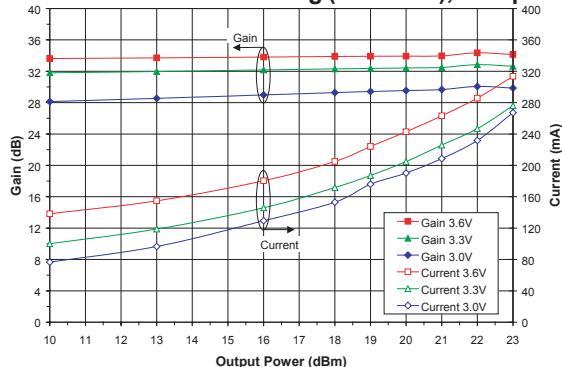

Figure 13: ACPR 1st & 2nd Sidelobes vs. Output Power Across Frequency (T_c = 25°C, V_{cc} = +3.3V) 802.11b Gaussian Filtering (BT = 0.45), 1 Mbps

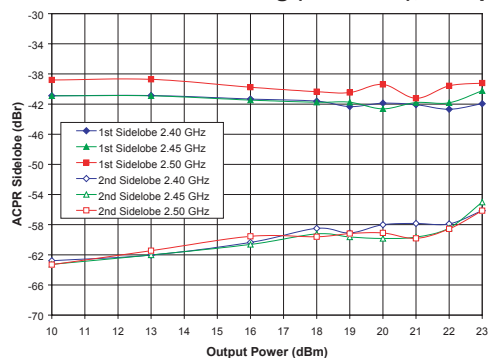

Figure 14: ACPR 1st & 2nd Sidelobes vs. Output Power Across Temp. (Freq = 2.45GHz, V_{CC} = +3.3V) 802.11b Gaussian Filtering (BT = 0.45), 1 Mbps

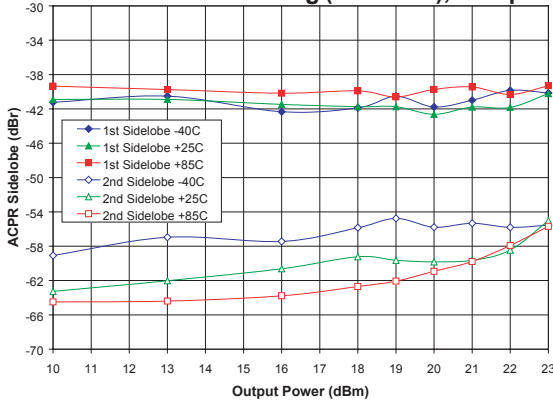
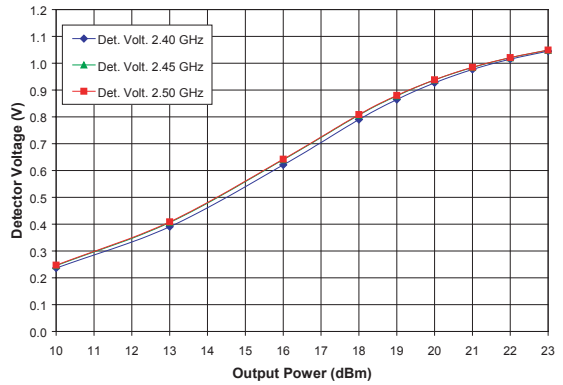

Figure 15: Detector Voltage vs. Output Power Across Frequency (T_C = 25°C, V_{CC} = +3.3V) 802.11b Gaussian Filtering (BT = 0.45), 1 Mbps



Note: Results at 2.50GHz Obscure the Results at 2.45GHz

Figure 16: Detector Voltage vs. Output Power Across Temp. (Freq = 2.45 GHz, V_{CC} = +3.3V) 802.11b Gaussian Filtering (BT = 0.45), 1 Mbps

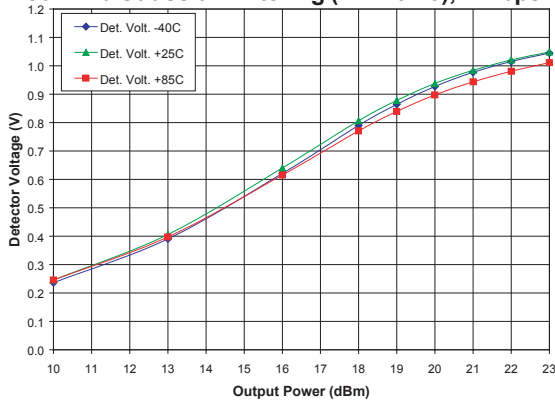

Figure 17: Input Return Loss vs. Frequency Across Temperature (V_{CC} = +3.3V)

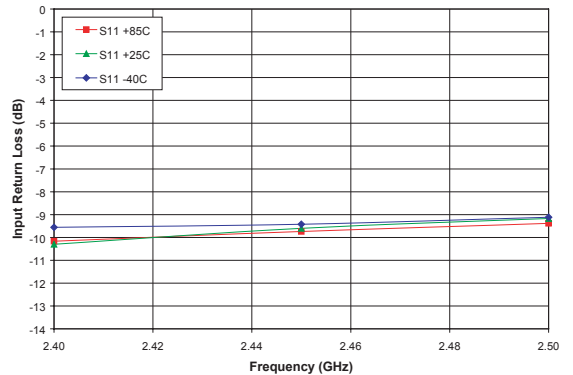
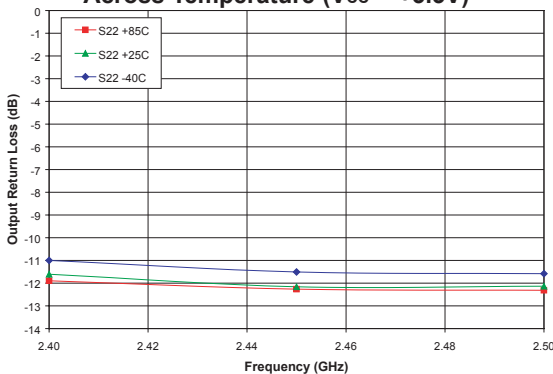

Figure 18: Output Return Loss vs. Frequency Across Temperature (V_{CC} = +3.3V)



APPLICATION INFORMATION

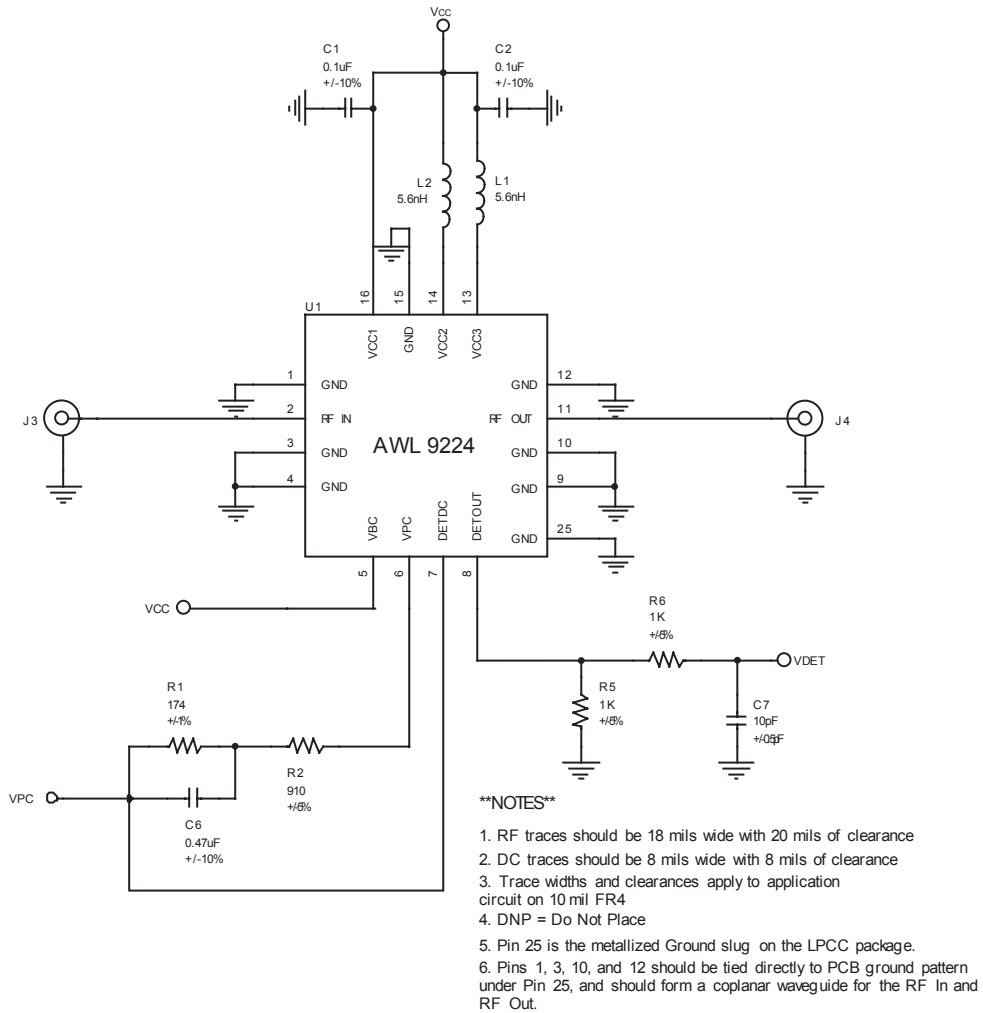
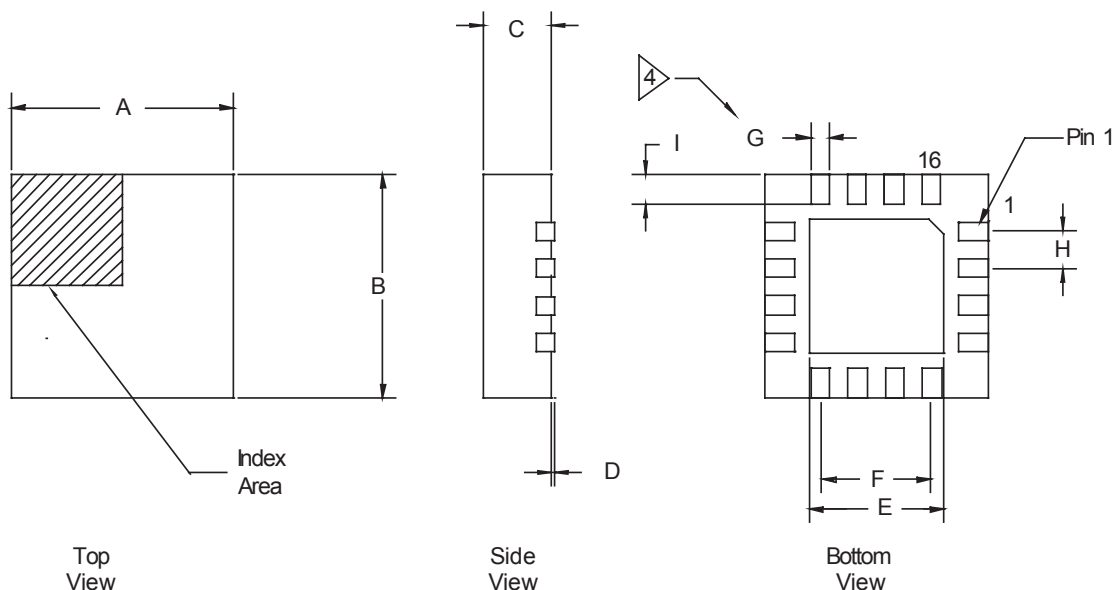

Figure 19: Application Circuit

PACKAGE OUTLINE



DIMENSION	MILLIMETERS		
	MIN	TYP	MAX
A	2.90	3.00	3.10
B	2.90	3.00	3.10
C	0.80	0.90	1.00
D	0.00	0.02	0.05
E	1.50	1.65	1.80
F	1.50 BSC.		
G	0.180	0.250	0.300
H	0.50 BSC.		
I	0.35	0.40	0.45

1. All dimensions are in millimeters, angles in degrees.
2. The terminal #1 identifier and pad numbering convention shall conform to JESD 95-1 SPP-012
3. Lead coplanarity: 0.05 max.
4. Dimension applies to metalized pad and is measured between 0.25 and 0.30 MM from pad tip.

Figure 20: S28 Package Outline - 16 Pin 3 x 3 x 0.9 mm LPCC

TOP BRAND



NOTES:

1. Line 1 - AK = Part Number Code
B = Current key
R = RoHS Compliance Designator
2. Line 2 - Date Code - 1st digit is last digit of current year
2nd & 3rd digits are work week
YWW
3. Line 3 - ZZZ = Last Three Numbers of Lot Number
X = COUNTRY CODE: C for CHINA, H for HONG KONG
T for THAILAND, W for TAIWAN
P for PHILIPPINES, I for INDONESIA
4. Pin 1 Indicator: MOLD NOTCH -or- INK DOT
5. TYPE: ELITE
SIZE: 1.5 Point
COLOR: LASER

Figure 21: Branding Specification

ORDERING INFORMATION

ORDER NUMBER	TEMPERATURE RANGE	PACKAGE DESCRIPTION	COMPONENT PACKAGING
AWL9224RS28Q1	-40 °C to +85°C	16 Pin 3 mm x 3 mm x 0.9 mm LPCC	1,000 piece Tape and Reel
AWL9224RS28P0	-40 °C to +85°C	16 Pin 3 mm x 3 mm x 0.9 mm LPCC	1-999 piece Tubes
AWL9224RS28P6	-40 °C to +85°C	16 Pin 3 mm x 3 mm x 0.9 mm LPCC	1-999 piece Tray
EVA9224RS28	-40 °C to +85°C	16 Pin 3 mm x 3 mm x 0.9 mm LPCC	1 piece Evaluation Board

**ANADIGICS, Inc.**

141 Mount Bethel Road
Warren, New Jersey 07059, U.S.A.

Tel: +1 (908) 668-5000

Fax: +1 (908) 668-5132

URL: <http://www.anadigics.com>

E-mail: Mktg@anadigics.com

IMPORTANT NOTICE

ANADIGICS, Inc. reserves the right to make changes to its products or to discontinue any product at any time without notice. The product specifications contained in Advanced Product Information sheets and Preliminary Data Sheets are subject to change prior to a product's formal introduction. Information in Data Sheets have been carefully checked and are assumed to be reliable; however, ANADIGICS assumes no responsibilities for inaccuracies. ANADIGICS strongly urges customers to verify that the information they are using is current before placing orders.

WARNING

ANADIGICS products are not intended for use in life support appliances, devices or systems. Use of an ANADIGICS product in any such application without written consent is prohibited.