

1GB Unbuffered DDR2 SDRAM DIMM

EBE11ED8AEFA (128M words × 72 bits, 2 Ranks)

Description

The EBE11ED8AEFA is 128M words × 72 bits, 2 ranks DDR2 SDRAM unbuffered module, mounting 18 pieces of 512M bits DDR2 SDRAM sealed in FBGA (μBGA®) package. Read and write operations are performed at the cross points of the CK and the /CK. This high-speed data transfer is realized by the 4 bits prefetch-pipelined architecture. Data strobe (DQS and /DQS) both for read and write are available for high speed and reliable data bus design. By setting extended mode register, the on-chip Delay Locked Loop (DLL) can be set enable or disable. This module provides high density mounting without utilizing surface mount technology. Decoupling capacitors are mounted beside each FBGA (μBGA) on the module board.

Note: Do not push the components or drop the modules in order to avoid mechanical defects, which may result in electrical defects.

Features

- 240-pin socket type dual in line memory module (DIMM)
 - PCB height: 30.0mm
 - Lead pitch: 1.0mm
 - Lead-free
- 1.8V power supply
- Data rate: 533Mbps/400Mbps (max.)
- 1.8V (SSTL_18 compatible) I/O
- Double-data-rate architecture: two data transfers per clock cycle
- Bi-directional, differential data strobe (DQS and /DQS) is transmitted/received with data, to be used in capturing data at the receiver
- DQS is edge aligned with data for READs: center-aligned with data for WRITEs
- Differential clock inputs (CK and /CK)
- DLL aligns DQ and DQS transitions with CK transitions
- Commands entered on each positive CK edge: data and data mask referenced to both edges of DQS
- Four internal banks for concurrent operation (Component)
- Data mask (DM) for write data
- Burst lengths: 4, 8
- /CAS Latency (CL): 3, 4, 5
- Auto precharge operation for each burst access
- Auto refresh and self refresh modes
- 7.8μs average periodic refresh interval
- Posted CAS by programmable additive latency for better command and data bus efficiency
- Off-Chip-Driver Impedance Adjustment and On-Die-Termination for better signal quality
- /DQS can be disabled for single-ended Data Strobe operation

Ordering Information

Part number	Data rate Mbps (max.)	Component JEDEC speed bin (CL-tRCD-tRP)	Package	Contact pad	Mounted devices
EBE11ED8AEFA-5C-E	533	DDR2-533 (4-4-4)	240-pin DIMM (lead-free)	Gold	EDE5108AESK-5C
EBE11ED8AEFA-4A-E	400	DDR2-400 (3-3-3)			EDE5108AESK-5C, -4A

Pin Configurations

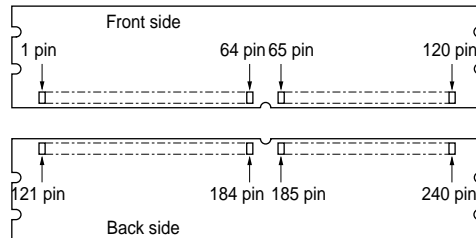

Pin No.	Pin name	Pin No.	Pin name	Pin No.	Pin name	Pin No.	Pin name
1	VREF	61	A4	121	VSS	181	VDD
2	VSS	62	VDD	122	DQ4	182	A3
3	DQ0	63	A2	123	DQ5	183	A1
4	DQ1	64	VDD	124	VSS	184	VDD
5	VSS	65	VSS	125	DM0	185	CK0
6	/DQS0	66	VSS	126	NC	186	/CK0
7	DQS0	67	VDD	127	VSS	187	VDD
8	VSS	68	NC	128	DQ6	188	A0
9	DQ2	69	VDD	129	DQ7	189	VDD
10	DQ3	70	A10/AP	130	VSS	190	BA1
11	VSS	71	BA0	131	DQ12	191	VDD
12	DQ8	72	VDD	132	DQ13	192	/RAS
13	DQ9	73	/WE	133	VSS	193	/CS0
14	VSS	74	/CAS	134	DM1	194	VDD
15	/DQS1	75	VDD	135	NC	195	ODT0
16	DQS1	76	/CS1	136	VSS	196	A13
17	VSS	77	ODT1	137	CK1	197	VDD
18	NC	78	VDD	138	/CK1	198	VSS
19	NC	79	VSS	139	VSS	199	DQ36
20	VSS	80	DQ32	140	DQ14	200	DQ37
21	DQ10	81	DQ33	141	DQ15	201	VSS
22	DQ11	82	VSS	142	VSS	202	DM4
23	VSS	83	/DQS4	143	DQ20	203	NC
24	DQ16	84	DQS4	144	DQ21	204	VSS
25	DQ17	85	VSS	145	VSS	205	DQ38
26	VSS	86	DQ34	146	DM2	206	DQ39
27	/DQS2	87	DQ35	147	NC	207	VSS
28	DQS2	88	VSS	148	VSS	208	DQ44
29	VSS	89	DQ40	149	DQ22	209	DQ45

Pin No.	Pin name	Pin No.	Pin name	Pin No.	Pin name	Pin No.	Pin name
30	DQ18	90	DQ41	150	DQ23	210	VSS
31	DQ19	91	VSS	151	VSS	211	DM5
32	VSS	92	/DQS5	152	DQ28	212	NC
33	DQ24	93	DQS5	153	DQ29	213	VSS
34	DQ25	94	VSS	154	VSS	214	DQ46
35	VSS	95	DQ42	155	DM3	215	DQ47
36	/DQS3	96	DQ43	156	NC	216	VSS
37	DQS3	97	VSS	157	VSS	217	DQ52
38	VSS	98	DQ48	158	DQ30	218	DQ53
39	DQ26	99	DQ49	159	DQ31	219	VSS
40	DQ27	100	VSS	160	VSS	220	CK2
41	VSS	101	SA2	161	CB4	221	/CK2
42	CB0	102	NC	162	CB5	222	VSS
43	CB1	103	VSS	163	VSS	223	DM6
44	VSS	104	/DQS6	164	DM8	224	NC
45	/DQS8	105	DQS6	165	NC	225	VSS
46	DQS8	106	VSS	166	VSS	226	DQ54
47	VSS	107	DQ50	167	CB6	227	DQ55
48	CB2	108	DQ51	168	CB7	228	VSS
49	CB3	109	VSS	169	VSS	229	DQ60
50	VSS	110	DQ56	170	VDD	230	DQ61
51	VDD	111	DQ57	171	CKE1	231	VSS
52	CKE0	112	VSS	172	VDD	232	DM7
53	VDD	113	/DQS7	173	NC	233	NC
54	NC	114	DQS7	174	NC	234	VSS
55	NC	115	VSS	175	VDD	235	DQ62
56	VDD	116	DQ58	176	A12	236	DQ63
57	A11	117	DQ59	177	A9	237	VSS
58	A7	118	VSS	178	VDD	238	VDDSPD
59	VDD	119	SDA	179	A8	239	SA0
60	A5	120	SCL	180	A6	240	SA1

Pin Description

Pin name	Function
	Address input
A0 to A13	Row address A0 to A13 Column address A0 to A9
A10 (AP)	Auto precharge
BA0, BA1	Bank select address
DQ0 to DQ63	Data input/output
CB0 to CB7	Check bit (Data input/output)
/RAS	Row address strobe command
/CAS	Column address strobe command
/WE	Write enable
/CS0, /CS1	Chip select
CKE0, CKE1	Clock enable
CK0 to CK2	Clock input
/CK0 to /CK2	Differential clock input
DQS0 to DQS8, /DQS0 to /DQS8	Input and output data strobe
DM0 to DM8	Input mask
SCL	Clock input for serial PD
SDA	Data input/output for serial PD
SA0 to SA2	Serial address input
VDD	Power for internal circuit
VDDSPD	Power for serial EEPROM
VREF	Input reference voltage
VSS	Ground
ODT0, ODT1	ODT control
NC	No connection

Serial PD Matrix

Byte No.	Function described	Bit7	Bit6	Bit5	Bit4	Bit3	Bit2	Bit1	Bit0	Hex value	Comments
0	Number of bytes utilized by module manufacturer	1	0	0	0	0	0	0	0	80H	128 bytes
1	Total number of bytes in serial PD device	0	0	0	0	1	0	0	0	08H	256 bytes
2	Memory type	0	0	0	0	1	0	0	0	08H	DDR2 SDRAM
3	Number of row address	0	0	0	0	1	1	1	0	0EH	14
4	Number of column address	0	0	0	0	1	0	1	0	0AH	10
5	Number of DIMM ranks	0	1	1	0	0	0	0	1	61H	2
6	Module data width	0	1	0	0	1	0	0	0	48H	72
7	Module data width continuation	0	0	0	0	0	0	0	0	00H	0
8	Voltage interface level of this assembly	0	0	0	0	0	1	0	1	05H	SSTL 1.8V
9	DDR SDRAM cycle time, CL = 5 -5C	0	0	1	1	1	1	0	1	3DH	3.75ns*1
	-4A	0	1	0	1	0	0	0	0	50H	5.0ns*1
10	SDRAM access from clock (tAC) -5C	0	1	0	1	0	0	0	0	50H	0.5ns*1
	-4A	0	1	1	0	0	0	0	0	60H	0.6ns*1
11	DIMM configuration type	0	0	0	0	0	0	1	0	02H	ECC
12	Refresh rate/type	1	0	0	0	0	0	1	0	82H	7.8μs
13	Primary SDRAM width	0	0	0	0	1	0	0	0	08H	× 8
14	Error checking SDRAM width	0	0	0	0	1	0	0	0	08H	× 8
15	Reserved	0	0	0	0	0	0	0	0	00H	0
16	SDRAM device attributes: Burst length supported	0	0	0	0	1	1	0	0	0CH	4,8
17	SDRAM device attributes: Number of banks on SDRAM device	0	0	0	0	0	1	0	0	04H	4
18	SDRAM device attributes: /CAS latency	0	0	1	1	1	0	0	0	38H	3, 4, 5
19	Reserved	0	0	0	0	0	0	0	0	00H	0
20	DIMM type information	0	0	0	0	0	0	1	0	02H	Unbuffered
21	SDRAM module attributes	0	0	0	0	0	0	0	0	00H	Normal
22	SDRAM device attributes: General	0	0	0	0	0	0	0	1	01H	Weak Driver
23	Minimum clock cycle time at CL = 4 -5C	0	0	1	1	1	1	0	1	3DH	3.75ns*1
	-4A	0	1	0	1	0	0	0	0	50H	5.0ns*1
24	Maximum data access time (tAC) from clock at CL = 4 -5C	0	1	0	1	0	0	0	0	50H	0.5ns*1
	-4A	0	1	1	0	0	0	0	0	60H	0.6ns*1
25	Minimum clock cycle time at CL = 3	0	1	0	1	0	0	0	0	50H	5.0ns*1
26	Maximum data access time (tAC) from clock at CL = 3	0	1	1	0	0	0	0	0	60H	0.6ns*1
27	Minimum row precharge time (tRP)	0	0	1	1	1	1	0	0	3CH	15ns

Byte No.	Function described	Bit7	Bit6	Bit5	Bit4	Bit3	Bit2	Bit1	Bit0	Hex value	Comments
28	Minimum row active to row active delay (tRRD)	0	0	0	1	1	1	1	0	1EH	7.5ns
29	Minimum /RAS to /CAS delay (tRCD)	0	0	1	1	1	1	0	0	3CH	15ns
30	Minimum active to precharge time (tRAS) -5C	0	0	1	0	1	1	0	1	2DH	45ns
	-4A	0	0	1	0	1	0	0	0	28H	40ns
31	Module rank density	1	0	0	0	0	0	0	0	80H	512M bytes
32	Address and command setup time before clock (tIS) -5C	0	0	1	0	0	1	0	1	25H	0.25ns ^{*1}
	-4A	0	0	1	1	0	1	0	1	35H	0.35ns ^{*1}
33	Address and command hold time after clock (tIH) -5C	0	0	1	1	1	0	0	0	38H	0.38ns ^{*1}
	-4A	0	1	0	0	1	0	0	0	48H	0.48ns ^{*1}
34	Data input setup time before clock (tDS) -5C	0	0	0	1	0	0	0	0	10H	0.10ns ^{*1}
	-4A	0	0	0	1	0	1	0	1	15H	0.15ns ^{*1}
35	Data input hold time after clock (tDH) -5C	0	0	1	0	0	0	1	1	23H	0.23ns ^{*1}
	-4A	0	0	1	0	1	0	0	0	28H	0.28ns ^{*1}
36	Write recovery time (tWR)	0	0	1	1	1	1	0	0	3CH	15ns ^{*1}
37	Internal write to read command delay (tWTR) -5C	0	0	0	1	1	1	1	0	1EH	7.5ns ^{*1}
	-4A	0	0	1	0	1	0	0	0	28H	10ns ^{*1}
38	Internal read to precharge command delay (tRTP)	0	0	0	1	1	1	1	0	1EH	7.5ns ^{*1}
39	Memory analysis probe characteristics	0	0	0	0	0	0	0	0	00H	TBD
40	Extension of Byte 41 and 42	0	0	0	0	0	0	0	0	00H	Undefined
41	Active command period (tRC) -5C	0	0	1	1	1	1	0	0	3CH	60ns ^{*1}
	-4A	0	0	1	1	0	1	1	1	37H	55ns ^{*1}
42	Auto refresh to active/ Auto refresh command cycle (tRFC)	0	1	1	0	1	0	0	1	69H	105ns ^{*1}
43	SDRAM tCK cycle max. (tCK max.)	1	0	0	0	0	0	0	0	80H	8ns ^{*1}
44	Dout to DQS skew -5C	0	0	0	1	1	1	1	0	1EH	0.30ns ^{*1}
	-4A	0	0	1	0	0	0	1	1	23H	0.35ns ^{*1}
45	Data hold skew (tQHS) -5C	0	0	1	0	1	0	0	0	28H	0.40ns ^{*1}
	-4A	0	0	1	0	1	1	0	1	2DH	0.45ns ^{*1}
46	PLL relock time	0	0	0	0	0	0	0	0	00H	Undefined
47 to 61		0	0	0	0	0	0	0	0	00H	

Byte No.	Function described	Bit7	Bit6	Bit5	Bit4	Bit3	Bit2	Bit1	Bit0	Hex value	Comments
62	SPD Revision	0	0	0	1	0	0	0	0	10H	Rev. 1.0
63	Checksum for bytes 0 to 62 -5C	1	1	0	0	0	1	0	1	C5H	
	-4A	0	0	1	1	1	1	1	1	3FH	
64 to 65	Manufacturer's JEDEC ID code	0	1	1	1	1	1	1	1	7FH	Continuation code
66	Manufacturer's JEDEC ID code	1	1	1	1	1	1	1	0	FEH	Elpida Memory
67 to 71	Manufacturer's JEDEC ID code	0	0	0	0	0	0	0	0	00H	
72	Manufacturing location	×	×	×	×	×	×	×	×	×	(ASCII-8bit code)
73	Module part number	0	1	0	0	0	1	0	1	45H	E
74	Module part number	0	1	0	0	0	0	1	0	42H	B
75	Module part number	0	1	0	0	0	1	0	1	45H	E
76	Module part number	0	0	1	1	0	0	0	1	31H	1
77	Module part number	0	0	1	1	0	0	0	1	31H	1
78	Module part number	0	1	0	0	0	1	0	1	45H	E
79	Module part number	0	1	0	0	0	1	0	0	44H	D
80	Module part number	0	0	1	1	1	0	0	0	38H	8
81	Module part number	0	1	0	0	0	0	0	1	41H	A
82	Module part number	0	1	0	0	0	1	0	1	45H	E
83	Module part number	0	1	0	0	0	1	1	0	46H	F
84	Module part number	0	1	0	0	0	0	0	1	41H	A
85	Module part number	0	0	1	0	1	1	0	1	2DH	—
86	Module part number -5C	0	0	1	1	0	1	0	1	35H	5
	-4A	0	0	1	1	0	1	0	0	34H	4
87	Module part number -4A	0	1	0	0	0	0	0	1	41H	A
	-5C	0	1	0	0	0	0	1	1	43H	C
88	Module part number	0	0	1	0	1	1	0	1	2DH	—
89	Module part number	0	1	0	0	0	1	0	1	45H	E
90	Module part number	0	0	1	0	0	0	0	0	20H	(Space)
91	Revision code	0	0	1	1	0	0	0	0	30H	Initial
92	Revision code	0	0	1	0	0	0	0	0	20H	(Space)
93	Manufacturing date	×	×	×	×	×	×	×	×	×	Year code (BCD)
94	Manufacturing date	×	×	×	×	×	×	×	×	×	Week code (BCD)
95 to 98	Module serial number										
99 to 127	Manufacture specific data										

Note: These specifications are defined based on component specification, not module.

Block Diagram

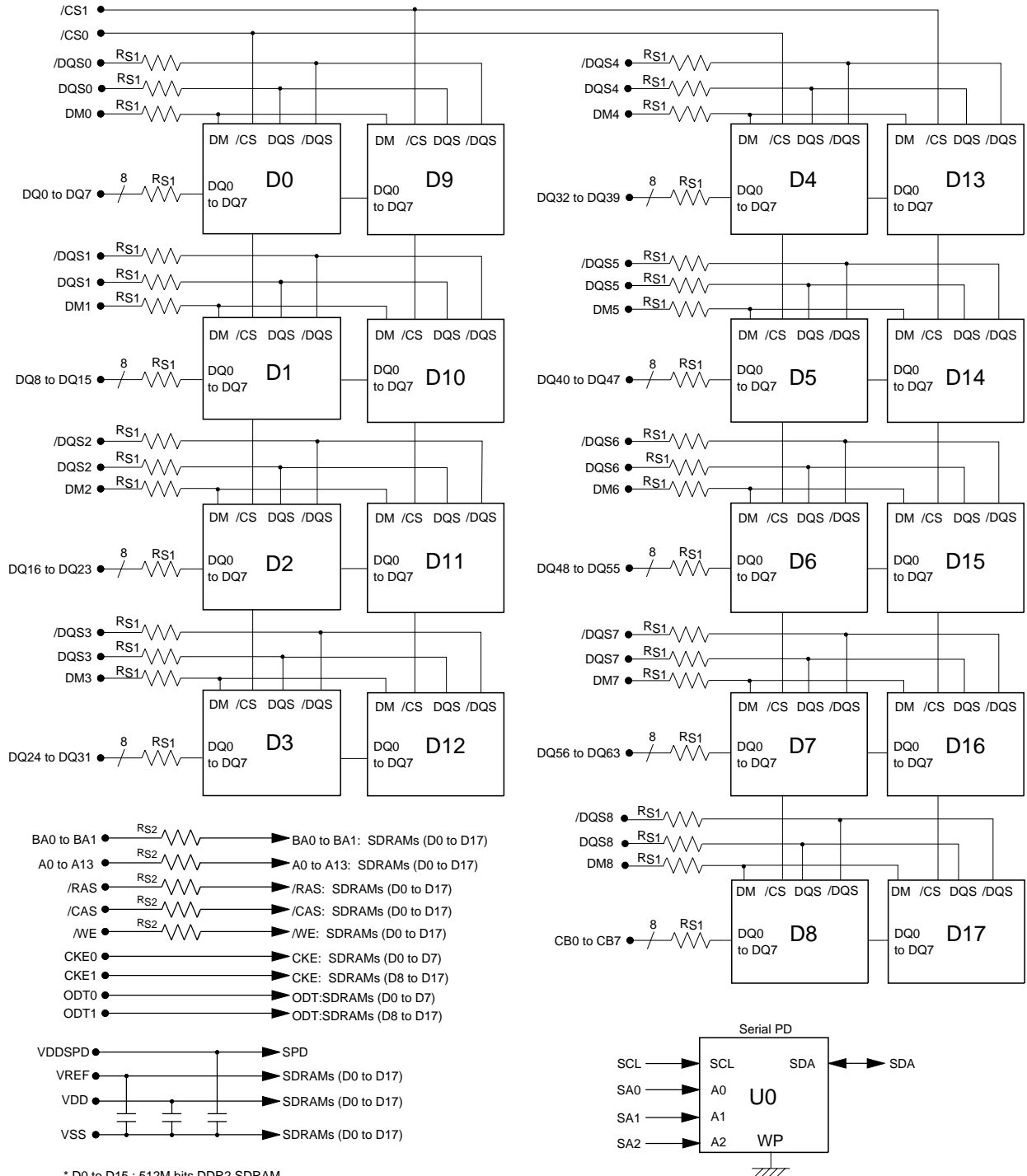

* D0 to D15 : 512M bits DDR2 SDRAM
 U0 : 2k bits EEPROM
 Rs1 : 22Ω
 Rs2 : 3.0Ω

- Notes :
1. DQ wiring may be changed within a byte.
 2. DQ, DQS, /DQS, ODT, DM, CKE, /CS relationships must be maintained as shown.
 3. Refer to the appropriate clock wiring topology under the DIMM wiring details section of this document.

Logical Clock Net Structure

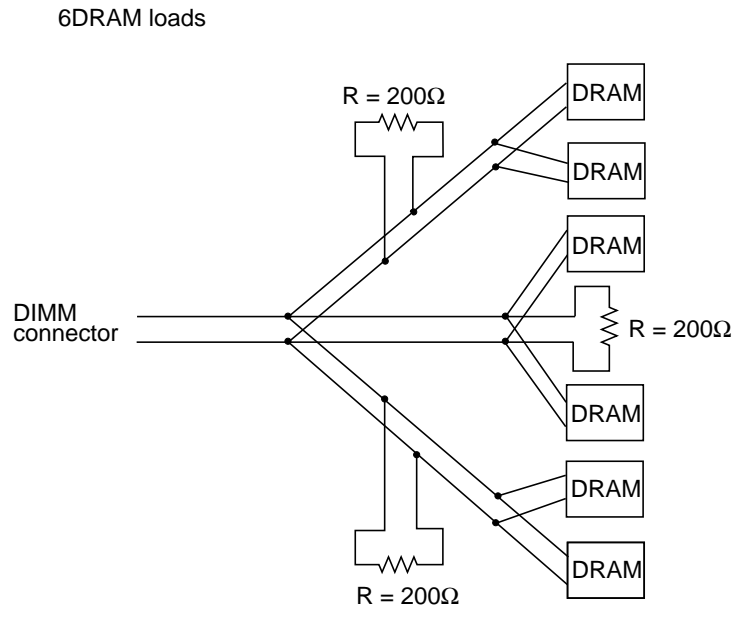

Electrical Specifications

- All voltages are referenced to VSS (GND).

Absolute Maximum Ratings

Parameter	Symbol	Value	Unit	Note
Voltage on any pin relative to VSS	VT	-0.5 to +2.3	V	1
Supply voltage relative to VSS	VDD	-0.5 to +2.3	V	
Short circuit output current	IOS	50	mA	1
Power dissipation	PD	8	W	
Operating case temperature	TC	0 to +85	°C	1
Storage temperature	Tstg	-55 to +100	°C	1

Note: 1. DDR2 SDRAM component specification.

Caution Exposing the device to stress above those listed in Absolute Maximum Ratings could cause permanent damage. The device is not meant to be operated under conditions outside the limits described in the operational section of this specification Exposure to Absolute Maximum Rating conditions for extended periods may affect device reliability.

DC Operating Conditions (TC = 0 to +85°C) (DDR2 SDRAM Component Specification)

Parameter	Symbol	min.	typ.	max.	Unit	Notes
Supply voltage	VDD, VDDQ	1.7	1.8	1.9	V	4
	VSS	0	0	0	V	
	VDDSPD	1.7	—	3.6	V	
Input reference voltage	VREF	$0.49 \times VDDQ$	$0.50 \times VDDQ$	$0.51 \times VDDQ$	V	1, 2
Termination voltage	VTT	$VREF - 0.04$	VREF	$VREF + 0.04$	V	3
DC input logic high	VIH (DC)	$VREF + 0.125$	—	$VDDQ + 0.3V$	V	
DC input low	VIL (DC)	-0.3	—	$VREF - 0.125$	V	
AC input logic high	VIH (AC)	$VREF + 0.250$	—	—	V	
AC input low	VIL (AC)	—	—	$VREF - 0.250$	V	

Notes: 1. The value of VREF may be selected by the user to provide optimum noise margin in the system. Typically the value of VREF is expected to be about $0.5 \times VDDQ$ of the transmitting device and VREF are expected to track variations in VDDQ.

2. Peak to peak AC noise on VREF may not exceed $\pm 2\%$ VREF (DC).
3. VTT of transmitting device must track VREF of receiving device.
4. VDDQ must be equal to VDD

DC Characteristics 1 (TC = 0 to +85°C, VDD = 1.8V ± 0.1V, VSS = 0V)

Parameter	Symbol	Grade	max.	Unit	Test condition	
Operating current (ACT-PRE) (Another rank is in IDD2P)	IDD0	-5C	1080	mA	one bank; tCK = tCK (IDD), tRC = tRC (IDD), tRAS = tRAS min.(IDD); CKE is H, /CS is H between valid commands;	
		-4A	927			
Operating current (ACT-PRE) (Another rank is in IDD3N)	IDD0	-5C	1575	mA	Address bus inputs are SWITCHING; Data bus inputs are SWITCHING	
		-4A	1395			
Operating current (ACT-READ-PRE) (Another rank is in IDD2P)	IDD1	-5C	1215	mA	one bank; IOU _T = 0mA; BL = 4, CL = CL(IDD), AL = 0; tCK = tCK (IDD), tRC = tRC (IDD), tRAS = tRAS min.(IDD); tRCD = tRCD (IDD);	
		-4A	1062			
Operating current (ACT-READ-PRE) (Another rank is in IDD3N)	IDD1	-5C	1710	mA	CKE is H, /CS is H between valid commands; Address bus inputs are SWITCHING; Data pattern is same as IDD4W	
		-4A	1530			
Precharge power-down standby current	IDD2P	-5C	180	mA	all banks idle; tCK = tCK (IDD); CKE is L;	
		-4A	144			Other control and address bus inputs are STABLE; Data bus inputs are FLOATING
Precharge quiet standby current	IDD2Q	-5C	450	mA	all banks idle; tCK = tCK (IDD); CKE is H, /CS is H;	
		-4A	360			Other control and address bus inputs are STABLE; Data bus inputs are FLOATING
Idle standby current	IDD2N	-5C	540	mA	all banks idle; tCK = tCK (IDD); CKE is H, /CS is H;	
		-4A	450			Other control and address bus inputs are SWITCHING; Data bus inputs are SWITCHING
Active power-down standby current	IDD3P-F	-5C	720	mA	all banks open; tCK = tCK (IDD); CKE is L;	Fast PDN Exit MRS(12) = 0
		-4A	630			
	IDD3P-S	-5C	450	mA	Other control and address bus inputs are STABLE; Data bus inputs are FLOATING	Slow PDN Exit MRS(12) = 1
		-4A	360			
Active standby current	IDD3N	-5C	1170	mA	all banks open; tCK = tCK (IDD), tRAS = tRAS max.(IDD), tRP = tRP (IDD); CKE is H, /CS is H between valid commands;	
		-4A	1080			Other control and address bus inputs are SWITCHING; Data bus inputs are SWITCHING
Operating current (Burst read operating) (Another rank is in IDD2P)	IDD4R	-5C	1800	mA	all banks open, continuous burst reads, IOU _T = 0mA; BL = 4, CL = CL(IDD), AL = 0; tCK = tCK (IDD), tRAS = tRAS max.(IDD), tRP = tRP (IDD);	
		-4A	1422			
Operating current (Burst read operating) (Another rank is in IDD3N)	IDD4R	-5C	2295	mA	CKE is H, /CS is H between valid commands; Address bus inputs are SWITCHING; Data pattern is same as IDD4W	
		-4A	1890			
Operating current (Burst write operating) (Another rank is in IDD2P)	IDD4W	-5C	1800	mA	all banks open, continuous burst writes; BL = 4, CL = CL(IDD), AL = 0; tCK = tCK (IDD), tRAS = tRAS max.(IDD), tRP = tRP (IDD);	
		-4A	1422			
Operating current (Burst write operating) (Another rank is in IDD3N)	IDD4W	-5C	2295	mA	CKE is H, /CS is H between valid commands; Address bus inputs are SWITCHING; Data bus inputs are SWITCHING	
		-4A	1890			
Auto-refresh current (Another rank is in IDD2P)	IDD5	-5C	2340	mA	tCK = tCK (IDD); Refresh command at every tRFC (IDD) interval;	
		-4A	2142			CKE is H, /CS is H between valid commands;
Auto-refresh current (Another rank is in IDD3N)	IDD5	-5C	2835	mA	Other control and address bus inputs are SWITCHING; Data bus inputs are SWITCHING	
		-4A	2610			

Parameter	Symbol	Grade	max.	Unit	Test condition
Self-refresh current	IDD6		108	mA	Self Refresh Mode; CK and /CK at 0V; CKE ≤ 0.2V; Other control and address bus inputs are FLOATING; Data bus inputs are FLOATING
Operating current (Bank interleaving) (Another rank is in IDD2P)	IDD7	-5C -4A	2970 2772	mA	all bank interleaving reads, IOUT = 0mA; BL = 4, CL = CL(IDD), AL = tRCD (IDD) - 1 × tCK (IDD); tCK = tCK (IDD), tRC = tRC (IDD), tRRD = tRRD(IDD), tRCD = 1 × tCK (IDD);
Operating current (Bank interleaving) (Another rank is in IDD3N)	IDD7	-5C -4A	3465 3240	mA	CKE is H, CS is H between valid commands; Address bus inputs are STABLE during DESELECTs; Data pattern is same as IDD4W;

- Notes: 1. IDD specifications are tested after the device is properly initialized.
- Input slew rate is specified by AC Input Test Condition.
 - IDD parameters are specified with ODT disabled.
 - Data bus consists of DQ, DM, DQS, /DQS, RDQS, /RDQS, LDQS, /LDQS, UDQS, and /UDQS. IDD values must be met with all combinations of EMRS bits 10 and 11.
 - Definitions for IDD
 - L is defined as $V_{IN} \leq V_{IL} (AC) (max.)$
 - H is defined as $V_{IN} \geq V_{IH} (AC) (min.)$
 - STABLE is defined as inputs stable at an H or L level
 - FLOATING is defined as inputs at $V_{REF} = V_{DDQ}/2$
 - SWITCHING is defined as:
 - inputs changing between H and L every other clock cycle (once per two clocks) for address and control signals, and inputs changing between H and L every other data transfer (once per clock) for DQ signals not including masks or strobes.
 - Refer to AC Timing for IDD Test Conditions.

AC Timing for IDD Test Conditions

For purposes of IDD testing, the following parameters are to be utilized.

Parameter	DDR2-533	DDR2-400	Unit
	4-4-4	3-3-3	
CL(IDD)	4	3	tCK
tRCD(IDD)	15	15	ns
tRC(IDD)	60	55	ns
tRRD(IDD)	7.5	7.5	ns
tCK(IDD)	3.75	5	ns
tRAS(min.)(IDD)	45	40	ns
tRAS(max.)(IDD)	70000	70000	ns
tRP(IDD)	15	15	ns
tRFC(IDD)	105	105	ns

DC Characteristics 2 (TC = 0 to +85°C, VDD, VDDQ = 1.8V ± 0.1V)

(DDR2 SDRAM Component Specification)

Parameter	Symbol	Value	Unit	Notes
Input leakage current	ILI	2	μA	VDD ≥ VIN ≥ VSS
Output leakage current	ILO	5	μA	VDDQ ≥ VOUT ≥ VSS
Minimum required output pull-up under AC test load	VOH	VTT + 0.603	V	5
Maximum required output pull-down under AC test load	VOL	VTT - 0.603	V	5
Output timing measurement reference level	VOTR	0.5 × VDDQ	V	1
Output minimum sink DC current	IOL	+13.4	mA	3, 4, 5
Output minimum source DC current	IOH	-13.4	mA	2, 4, 5

- Notes: 1. The VDDQ of the device under test is referenced.
 2. VDDQ = 1.7V; VOUT = 1.42V.
 3. VDDQ = 1.7V; VOUT = 0.28V.
 4. The DC value of VREF applied to the receiving device is expected to be set to VTT.
 5. After OCD calibration to 18Ω at TA = 25°C, VDD = VDDQ = 1.8V.

DC Characteristics 3 (TC = 0 to +85°C, VDD, VDDQ = 1.8V ± 0.1V)

(DDR2 SDRAM Component Specification)

Parameter	Symbol	min.	max.	Unit	Notes
AC differential input voltage	VID (AC)	0.5	VDDQ + 0.6	V	1
AC differential cross point voltage	VIX (AC)	0.5 × VDDQ - 0.175	0.5 × VDDQ + 0.175	V	2
AC differential cross point voltage	VOX (AC)	0.5 × VDDQ - 0.125	0.5 × VDDQ + 0.125	V	3

- Notes: 1. VID(AC) specifies the input differential voltage |VTR -VCP| required for switching, where VTR is the true input signal (such as CK, DQS, LDQS or UDQS) and VCP is the complementary input signal (such as /CK, /DQS, /LDQS or /UDQS). The minimum value is equal to VIH(AC) - VIL(AC).
 2. The typical value of VIX(AC) is expected to be about 0.5 × VDDQ of the transmitting device and VIX(AC) is expected to track variations in VDDQ . VIX(AC) indicates the voltage at which differential input signals must cross.
 3. The typical value of VOX(AC) is expected to be about 0.5 × VDDQ of the transmitting device and VOX(AC) is expected to track variations in VDDQ . VOX(AC) indicates the voltage at which differential output signals must cross.

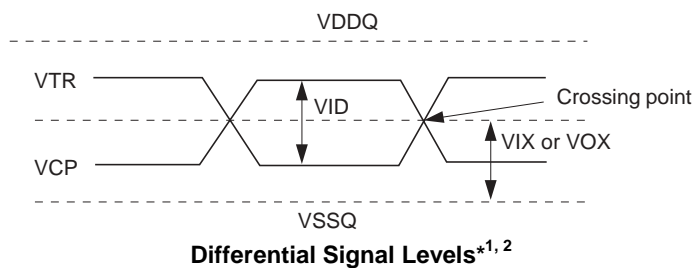

ODT DC Electrical Characteristics (TC = 0 to +85°C, VDD, VDDQ = 1.8V ± 0.1V)

(DDR2 SDRAM Component Specification)

Parameter	Symbol	min.	typ.	max.	Unit	Note
Rtt effective impedance value for EMRS (A6, A2) = 0, 1; 75 Ω	Rtt1(eff)	60	75	90	Ω	1
Rtt effective impedance value for EMRS (A6, A2) = 1, 0; 150 Ω	Rtt2(eff)	120	150	180	Ω	1
Rtt effective impedance value for EMRS (A6, A2) = 1, 1; 50 Ω	Rtt3(eff)	40	50	60	Ω	1
Deviation of VM with respect to VDDQ/2	ΔVM	-6	—	+6	%	1

Note: 1. Test condition for Rtt measurements.

Measurement Definition for Rtt(eff)

Apply VIH (AC) and VIL (AC) to test pin separately, then measure current I(VIH(AC)) and I(VIL(AC)) respectively. VIH(AC), and VDDQ values defined in SSTL_18.

$$R_{tt}(\text{eff}) = \frac{V_{IH}(\text{AC}) - V_{IL}(\text{AC})}{I(V_{IH}(\text{AC})) - I(V_{IL}(\text{AC}))}$$

Measurement Definition for ΔVM

Measure voltage (VM) at test pin (midpoint) with no load.

$$\Delta VM = \left(\frac{2 \times VM}{VDDQ} - 1 \right) \times 100\%$$

OCD Default Characteristics (TC = 0 to +85°C, VDD, VDDQ = 1.8V ± 0.1V)

(DDR2 SDRAM Component Specification)

Parameter	min.	typ.	max.	Unit	Notes
Output impedance	12.6	18	23.4	Ω	1
Pull-up and pull-down mismatch	0	—	4	Ω	1, 2
Output slew rate	1.5	—	5	V/ns	3, 4

Notes: 1. Impedance measurement condition for output source DC current: VDDQ = 1.7V; VOUT = 1420mV; (VOUT-VDDQ)/IOH must be less than 23.4Ω for values of VOUT between VDDQ and VDDQ-280mV. Impedance measurement condition for output sink DC current: VDDQ = 1.7V; VOUT = 280mV; VOUT/IOI must be less than 23.4Ω for values of VOUT between 0V and 280mV.

- Mismatch is absolute value between pull up and pull down, both are measured at same temperature and voltage.
- Slew rate measured from VIL(AC) to VIH(AC).
- The absolute value of the slew rate as measured from DC to DC is equal to or greater than the slew rate as measured from AC to AC. This is guaranteed by design and characterization.

Pin Capacitance (TA = 25°C, VDD = 1.8V ± 0.1V)

(DDR2 SDRAM Component Specification)

Parameter	Symbol	Pins	min.	max.	Unit	Note
Input capacitance	CI1	Address, /RAS, /CAS, /WE, /CS, CKE, ODT	1.0	2.0	pF	
Input capacitance	CI2	CK, /CK	1.0	2.0	pF	
Data and DQS input/output capacitance	CO	DQ, DQS, /DQS, DM, CB	2.5	4.0	pF	

AC Characteristics (TC = 0 to +85°C, VDD, VDDQ = 1.8V ± 0.1V, VSS = 0V)
(DDR2 SDRAM Component Specification)

Frequency (Mbps)	Symbol	-5C		-4A		Unit	Notes
		min.	max.	min.	max.		
		533		400			
/CAS latency	CL	4	5	3	5	tCK	
Active to read or write command delay	tRCD	15	—	15	—	ns	
Precharge command period	tRP	15	—	15	—	ns	
Active to active/auto refresh command time	tRC	60	—	55	—	ns	
DQ output access time from CK, /CK	tAC	-500	+500	-600	+600	ps	
DQS output access time from CK, /CK	tDQSK	-450	+450	-500	+500	ps	
CK high-level width	tCH	0.45	0.55	0.45	0.55	tCK	
CK low-level width	tCL	0.45	0.55	0.45	0.55	tCK	
CK half period	tHP	min. (tCL, tCH)	—	min. (tCL, tCH)	—	ps	
Clock cycle time	tCK	3750	8000	5000	8000	ps	
DQ and DM input hold time	tDH	225	—	275	—	ps	5
DQ and DM input setup time	tDS	100	—	150	—	ps	4
Control and Address input pulse width for each input	tIPW	0.6	—	0.6	—	tCK	
DQ and DM input pulse width for each input	tDIPW	0.35	—	0.35	—	tCK	
Data-out high-impedance time from CK,/CK	tHZ	—	tAC max.	—	tAC max.	ps	
Data-out low-impedance time from CK,/CK	tLZ	tAC min.	tAC max.	tAC min.	tAC max.	ps	
DQS-DQ skew for DQS and associated DQ signals	tDQSQ	—	300	—	350	ps	
DQ hold skew factor	tQHS	—	400	—	450	ps	
DQ/DQS output hold time from DQS	tQH	tHP – tQHS	—	tHP – tQHS	—	ps	
Write command to first DQS latching transition	tDQSS	WL – 0.25	WL + 0.25	WL – 0.25	WL + 0.25	tCK	
DQS input high pulse width	tDQSH	0.35	—	0.35	—	tCK	
DQS input low pulse width	tDQSL	0.35	—	0.35	—	tCK	
DQS falling edge to CK setup time	tDSS	0.2	—	0.2	—	tCK	
DQS falling edge hold time from CK	tDSH	0.2	—	0.2	—	tCK	
Mode register set command cycle time	tMRD	2	—	2	—	tCK	
Write postamble	tWPST	0.4	0.6	0.4	0.6	tCK	
Write preamble	tWPRE	0.35	—	0.35	—	tCK	
Address and control input hold time	tIH	375	—	475	—	ps	5
Address and control input setup time	tIS	250	—	350	—	ps	4
Read preamble	tRPRE	0.9	1.1	0.9	1.1	tCK	
Read postamble	tRPST	0.4	0.6	0.4	0.6	tCK	
Active to precharge command	tRAS	45	70000	40	70000	ns	
Active to auto-precharge delay	tRAP	tRCD min.	—	tRCD min.	—	ns	

Frequency (Mbps)	Symbol	-5C		-4A		Unit	Notes
		533	max.	400	max.		
Active bank A to active bank B command period	tRRD	7.5	—	7.5	—	ns	
Write recovery time	tWR	15	—	15	—	ns	
Auto precharge write recovery + precharge time	tDAL	(tWR/tCK)+ (tRP/tCK)	—	(tWR/tCK)+ (tRP/tCK)	—	tCK	1
Internal write to read command delay	tWTR	7.5	—	10	—	ns	
Internal read to precharge command delay	tRTP	7.5	—	7.5	—	ns	
Exit self refresh to a non-read command	tXSNR	tRFC + 10	—	tRFC + 10	—	ns	
Exit self refresh to a read command	tXSRD	200	—	200	—	tCK	
Exit precharge power down to any non-read command	tXP	2	—	2	—	tCK	
Exit active power down to read command	tXARD	2	—	2	—	tCK	3
Exit active power down to read command (slow exit/low power mode)	tXARDS	6 – AL	—	6 – AL	—	tCK	2, 3
CKE minimum pulse width (high and low pulse width)	tCKE	3	—	3	—	tCK	
Output impedance test driver delay	tOIT	0	12	0	12	ns	
Auto refresh to active/auto refresh command time	tRFC	105	—	105	—	ns	
Average periodic refresh interval	tREFI	—	7.8	—	7.8	μs	
Minimum time clocks remains ON after CKE asynchronously drops low	tDELAY	tIS + tCK + tIH	—	tIS + tCK + tIH	—	ns	

Notes: 1. For each of the terms above, if not already an integer, round to the next higher integer.

2. AL: Additive Latency.

3. MRS A12 bit defines which active power down exit timing to be applied.

4. The figures of Input Waveform Timing 1 and 2 are referenced from the input signal crossing at the VIH(AC) level for a rising signal and VIL(AC) for a falling signal applied to the device under test.

5. The figures of Input Waveform Timing 1 and 2 are referenced from the input signal crossing at the VIH(DC) level for a rising signal and VIL(DC) for a falling signal applied to the device under test.

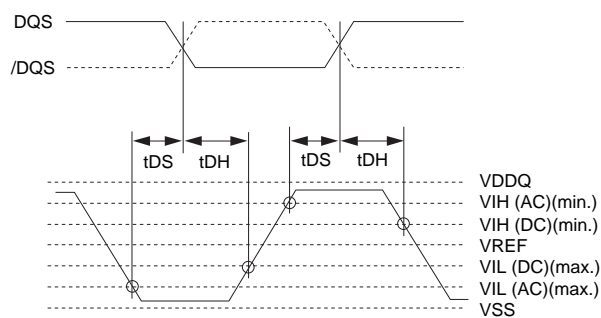

Input Waveform Timing 1 (tDS, tDH)

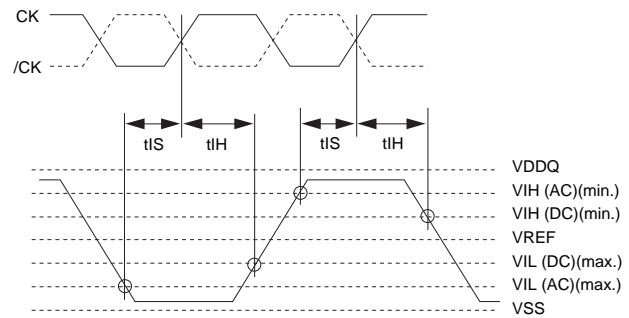

Input Waveform Timing 2 (tIS, tIH)

ODT AC Electrical Characteristics (DDR2 SDRAM Component Specification)

Parameter	Symbol	min.	max.	Unit	Notes
ODT turn-on delay	tAOND	2	2	tCK	
ODT turn-on	tAON	tAC(min)	tAC(max) + 1000	ps	1
ODT turn-on (power down mode)	tAONPD	tAC(min) + 2000	2tCK + tAC(max) + 1000	ps	
ODT turn-off delay	tAOFD	2.5	2.5	tCK	
ODT turn-off	tAOF	tAC(min)	tAC(max) + 600	ps	2
ODT turn-off (power down mode)	tAOFPD	tAC(min) + 2000	2.5tCK + tAC(max) + 1000	ps	
ODT to power down entry latency	tANPD	3	3	tCK	
ODT power down exit latency	tAXPD	8	8	tCK	

- Notes: 1. ODT turn on time min is when the device leaves high impedance and ODT resistance begins to turn on. ODT turn on time max is when the ODT resistance is fully on. Both are measured from tAOND.
2. ODT turn off time min is when the device starts to turn off ODT resistance. ODT turn off time max is when the bus is in high impedance. Both are measured from tAOFD.

AC Input Test Conditions

Parameter	Symbol	Value	Unit	Notes
Input reference voltage	VREF	0.5 × VDDQ	V	1
Input signal maximum peak to peak swing	VSWING(max.)	1.0	V	1
Input signal maximum slew rate	SLEW	1.0	V/ns	2, 3

- Notes: 1. Input waveform timing is referenced to the input signal crossing through the VREF level applied to the device under test.
2. The input signal minimum slew rate is to be maintained over the range from VIH(DC) (max.) to VIH(AC) (min.) for rising edges and the range from VIH(DC) (min.) to VIL(AC) (max.) for falling edges as shown in the below figure.
3. AC timings are referenced with input waveforms switching from VIL(AC) to VIH(AC) on the positive transitions and VIH(AC) to VIL(AC) on the negative transitions.

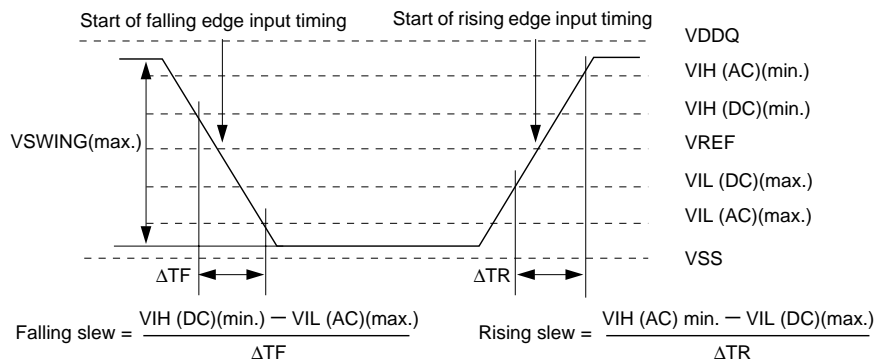

AC Input Test Signal Wave forms

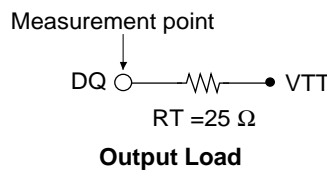

Pin Functions

CK, /CK (input pin)

The CK and the /CK are the master clock inputs. All inputs except DMs, DQSs and DQs are referred to the cross point of the CK rising edge and the VREF level. When a read operation, DQSs and DQs are referred to the cross point of the CK and the /CK. When a write operation, DMs and DQs are referred to the cross point of the DQS and the VREF level. DQSs for write operation are referred to the cross point of the CK and the /CK.

/CS (input pin)

When /CS is low, commands and data can be input. When /CS is high, all inputs are ignored. However, internal operations (bank active, burst operations, etc.) are held.

/RAS, /CAS, and /WE (input pins)

These pins define operating commands (read, write, etc.) depending on the combinations of their voltage levels. See "Command operation".

A0 to A13 (input pins)

Row address (AX0 to AX13) is determined by the A0 to the A13 level at the cross point of the CK rising edge and the VREF level in a bank active command cycle. Column address (AY0 to AY9) is loaded via the A0 to the A9 at the cross point of the CK rising edge and the VREF level in a read or a write command cycle. This column address becomes the starting address of a burst operation.

A10 (AP) (input pin)

A10 defines the precharge mode when a precharge command, a read command or a write command is issued. If A10 = high when a precharge command is issued, all banks are precharged. If A10 = low when a precharge command is issued, only the bank that is selected by BA1, BA0 is precharged. If A10 = high when read or write command, auto-precharge function is enabled. While A10 = low, auto-precharge function is disabled.

BA0 and BA1 (input pins)

BA0, BA1 are bank select signals (BA). The memory array is divided into bank 0, bank 1, bank 2 and bank 3. (See Bank Select Signal Table)

[Bank Select Signal Table]

	BA0	BA1
Bank 0	L	L
Bank 1	H	L
Bank 2	L	H
Bank 3	H	H

Remark: H: VIH. L: VIL.

CKE (input pin)

CKE controls power down and self-refresh. The power down and the self-refresh commands are entered when the CKE is driven low and exited when it resumes to high.

The CKE level must be kept for 1 CK cycle at least, that is, if CKE changes at the cross point of the CK rising edge and the VREF level with proper setup time tIS, at the next CK rising edge CKE level must be kept with proper hold time tIH.

DQ and CB (input and output pins)

Data are input to and output from these pins.

DQS and /DQS (input and output pin)

DQS and /DQS provide the read data strobes (as output) and the write data strobes (as input).

DM (input pins)

DM is the reference signal of the data input mask function. DMs are sampled at the cross point of DQS and /DQS.

VDD (power supply pins)

1.8V is applied. (VDD is for the internal circuit.)

VDDSPD (power supply pin)

1.8V is applied (For serial EEPROM).

VSS (power supply pin)

Ground is connected.

Detailed Operation Part and Timing Waveforms

Refer to the EDE5104AESK, EDE5108AESK datasheet (E0562E).

Physical Outline

Unit: mm

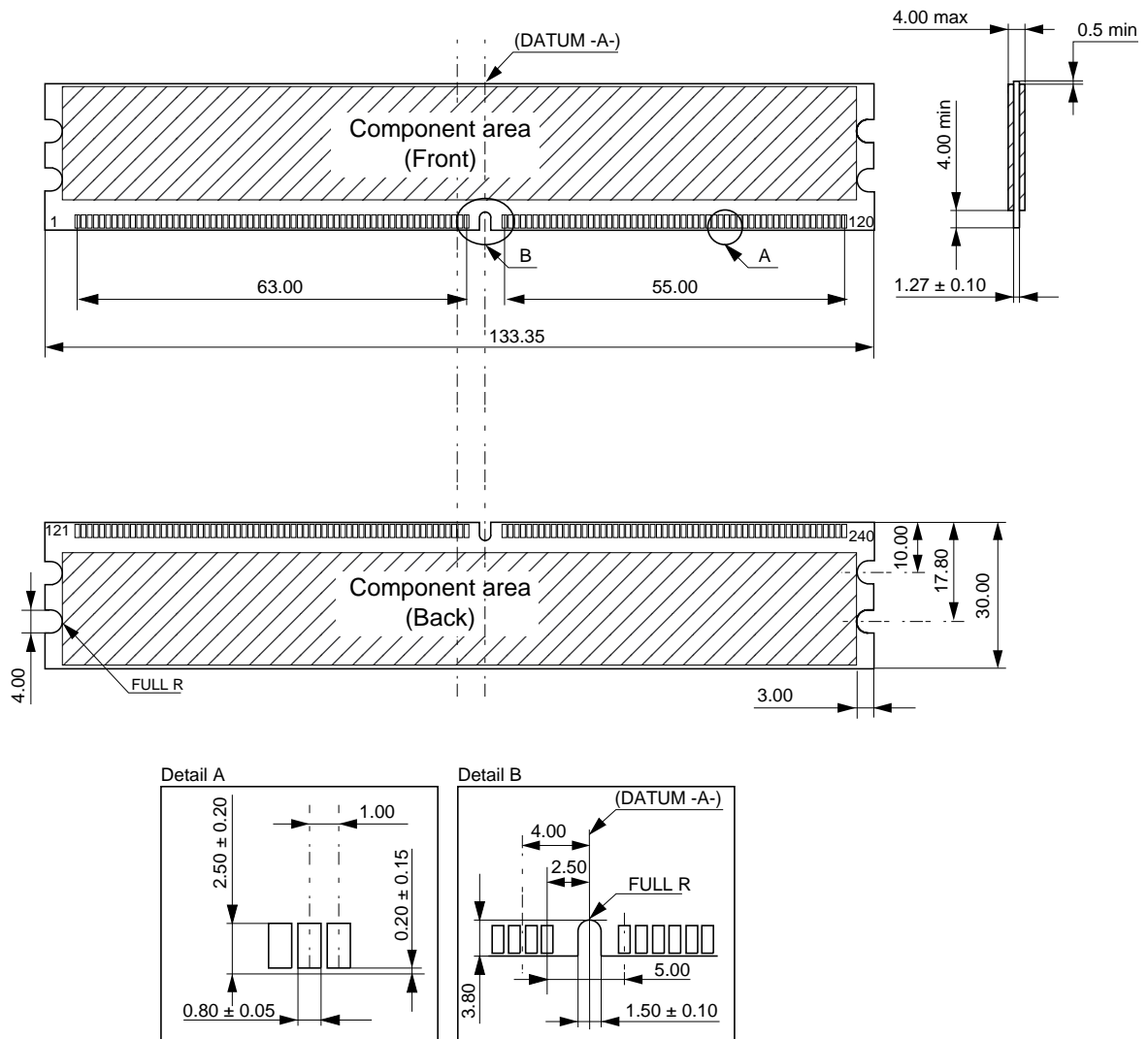

ECA-TS2-0093-01

CAUTION FOR HANDLING MEMORY MODULES

When handling or inserting memory modules, be sure not to touch any components on the modules, such as the memory ICs, chip capacitors and chip resistors. It is necessary to avoid undue mechanical stress on these components to prevent damaging them.

In particular, do not push module cover or drop the modules in order to protect from mechanical defects, which would be electrical defects.

When re-packing memory modules, be sure the modules are not touching each other.

Modules in contact with other modules may cause excessive mechanical stress, which may damage the modules.

MDE0202

NOTES FOR CMOS DEVICES**① PRECAUTION AGAINST ESD FOR MOS DEVICES**

Exposing the MOS devices to a strong electric field can cause destruction of the gate oxide and ultimately degrade the MOS devices operation. Steps must be taken to stop generation of static electricity as much as possible, and quickly dissipate it, when once it has occurred. Environmental control must be adequate. When it is dry, humidifier should be used. It is recommended to avoid using insulators that easily build static electricity. MOS devices must be stored and transported in an anti-static container, static shielding bag or conductive material. All test and measurement tools including work bench and floor should be grounded. The operator should be grounded using wrist strap. MOS devices must not be touched with bare hands. Similar precautions need to be taken for PW boards with semiconductor MOS devices on it.

② HANDLING OF UNUSED INPUT PINS FOR CMOS DEVICES

No connection for CMOS devices input pins can be a cause of malfunction. If no connection is provided to the input pins, it is possible that an internal input level may be generated due to noise, etc., hence causing malfunction. CMOS devices behave differently than Bipolar or NMOS devices. Input levels of CMOS devices must be fixed high or low by using a pull-up or pull-down circuitry. Each unused pin should be connected to V_{DD} or GND with a resistor, if it is considered to have a possibility of being an output pin. The unused pins must be handled in accordance with the related specifications.

③ STATUS BEFORE INITIALIZATION OF MOS DEVICES

Power-on does not necessarily define initial status of MOS devices. Production process of MOS does not define the initial operation status of the device. Immediately after the power source is turned ON, the MOS devices with reset function have not yet been initialized. Hence, power-on does not guarantee output pin levels, I/O settings or contents of registers. MOS devices are not initialized until the reset signal is received. Reset operation must be executed immediately after power-on for MOS devices having reset function.

CME0107

μBGA is a registered trademark of Tessera, Inc.

All other trademarks are the intellectual property of their respective owners.

The information in this document is subject to change without notice. Before using this document, confirm that this is the latest version.

No part of this document may be copied or reproduced in any form or by any means without the prior written consent of Elpida Memory, Inc.

Elpida Memory, Inc. does not assume any liability for infringement of any intellectual property rights (including but not limited to patents, copyrights, and circuit layout licenses) of Elpida Memory, Inc. or third parties by or arising from the use of the products or information listed in this document. No license, express, implied or otherwise, is granted under any patents, copyrights or other intellectual property rights of Elpida Memory, Inc. or others.

Descriptions of circuits, software and other related information in this document are provided for illustrative purposes in semiconductor product operation and application examples. The incorporation of these circuits, software and information in the design of the customer's equipment shall be done under the full responsibility of the customer. Elpida Memory, Inc. assumes no responsibility for any losses incurred by customers or third parties arising from the use of these circuits, software and information.

[Product applications]

Elpida Memory, Inc. makes every attempt to ensure that its products are of high quality and reliability. However, users are instructed to contact Elpida Memory's sales office before using the product in aerospace, aeronautics, nuclear power, combustion control, transportation, traffic, safety equipment, medical equipment for life support, or other such application in which especially high quality and reliability is demanded or where its failure or malfunction may directly threaten human life or cause risk of bodily injury.

[Product usage]

Design your application so that the product is used within the ranges and conditions guaranteed by Elpida Memory, Inc., including the maximum ratings, operating supply voltage range, heat radiation characteristics, installation conditions and other related characteristics. Elpida Memory, Inc. bears no responsibility for failure or damage when the product is used beyond the guaranteed ranges and conditions. Even within the guaranteed ranges and conditions, consider normally foreseeable failure rates or failure modes in semiconductor devices and employ systemic measures such as fail-safes, so that the equipment incorporating Elpida Memory, Inc. products does not cause bodily injury, fire or other consequential damage due to the operation of the Elpida Memory, Inc. product.

[Usage environment]

This product is not designed to be resistant to electromagnetic waves or radiation. This product must be used in a non-condensing environment.

If you export the products or technology described in this document that are controlled by the Foreign Exchange and Foreign Trade Law of Japan, you must follow the necessary procedures in accordance with the relevant laws and regulations of Japan. Also, if you export products/technology controlled by U.S. export control regulations, or another country's export control laws or regulations, you must follow the necessary procedures in accordance with such laws or regulations.

If these products/technology are sold, leased, or transferred to a third party, or a third party is granted license to use these products, that third party must be made aware that they are responsible for compliance with the relevant laws and regulations.

M01E0107