

To all our customers

Regarding the change of names mentioned in the document, such as Hitachi Electric and Hitachi XX, to Renesas Technology Corp.

The semiconductor operations of Mitsubishi Electric and Hitachi were transferred to Renesas Technology Corporation on April 1st 2003. These operations include microcomputer, logic, analog and discrete devices, and memory chips other than DRAMs (flash memory, SRAMs etc.) Accordingly, although Hitachi, Hitachi, Ltd., Hitachi Semiconductors, and other Hitachi brand names are mentioned in the document, these names have in fact all been changed to Renesas Technology Corp. Thank you for your understanding. Except for our corporate trademark, logo and corporate statement, no changes whatsoever have been made to the contents of the document, and these changes do not constitute any alteration to the contents of the document itself.

Renesas Technology Home Page: <http://www.renesas.com>

Renesas Technology Corp.
Customer Support Dept.
April 1, 2003

Cautions

Keep safety first in your circuit designs!

1. Renesas Technology Corporation puts the maximum effort into making semiconductor products better and more reliable, but there is always the possibility that trouble may occur with them. Trouble with semiconductors may lead to personal injury, fire or property damage.
Remember to give due consideration to safety when making your circuit designs, with appropriate measures such as (i) placement of substitutive, auxiliary circuits, (ii) use of nonflammable material or (iii) prevention against any malfunction or mishap.

Notes regarding these materials

1. These materials are intended as a reference to assist our customers in the selection of the Renesas Technology Corporation product best suited to the customer's application; they do not convey any license under any intellectual property rights, or any other rights, belonging to Renesas Technology Corporation or a third party.
2. Renesas Technology Corporation assumes no responsibility for any damage, or infringement of any third-party's rights, originating in the use of any product data, diagrams, charts, programs, algorithms, or circuit application examples contained in these materials.
3. All information contained in these materials, including product data, diagrams, charts, programs and algorithms represents information on products at the time of publication of these materials, and are subject to change by Renesas Technology Corporation without notice due to product improvements or other reasons. It is therefore recommended that customers contact Renesas Technology Corporation or an authorized Renesas Technology Corporation product distributor for the latest product information before purchasing a product listed herein.
The information described here may contain technical inaccuracies or typographical errors. Renesas Technology Corporation assumes no responsibility for any damage, liability, or other loss rising from these inaccuracies or errors.
Please also pay attention to information published by Renesas Technology Corporation by various means, including the Renesas Technology Corporation Semiconductor home page (<http://www.renesas.com>).
4. When using any or all of the information contained in these materials, including product data, diagrams, charts, programs, and algorithms, please be sure to evaluate all information as a total system before making a final decision on the applicability of the information and products. Renesas Technology Corporation assumes no responsibility for any damage, liability or other loss resulting from the information contained herein.
5. Renesas Technology Corporation semiconductors are not designed or manufactured for use in a device or system that is used under circumstances in which human life is potentially at stake. Please contact Renesas Technology Corporation or an authorized Renesas Technology Corporation product distributor when considering the use of a product contained herein for any specific purposes, such as apparatus or systems for transportation, vehicular, medical, aerospace, nuclear, or undersea repeater use.
6. The prior written approval of Renesas Technology Corporation is necessary to reprint or reproduce in whole or in part these materials.
7. If these products or technologies are subject to the Japanese export control restrictions, they must be exported under a license from the Japanese government and cannot be imported into a country other than the approved destination.
Any diversion or reexport contrary to the export control laws and regulations of Japan and/or the country of destination is prohibited.
8. Please contact Renesas Technology Corporation for further details on these materials or the products contained therein.

SH7058 E6000H Emulator HS7058EPH60H

User's Manual



ADE-702-360A
Rev. 2.0
10/28/02
Hitachi, Ltd.

HS7058EPH60HE

Cautions

1. Hitachi neither warrants nor grants licenses of any rights of Hitachi's or any third party's patent, copyright, trademark, or other intellectual property rights for information contained in this document. Hitachi bears no responsibility for problems that may arise with third party's rights, including intellectual property rights, in connection with use of the information contained in this document.
2. Products and product specifications may be subject to change without notice. Confirm that you have received the latest product standards or specifications before final design, purchase or use.
3. Hitachi makes every attempt to ensure that its products are of high quality and reliability. However, contact Hitachi's sales office before using the product in an application that demands especially high quality and reliability or where its failure or malfunction may directly threaten human life or cause risk of bodily injury, such as aerospace, aeronautics, nuclear power, combustion control, transportation, traffic, safety equipment or medical equipment for life support.
4. Design your application so that the product is used within the ranges guaranteed by Hitachi particularly for maximum rating, operating supply voltage range, heat radiation characteristics, installation conditions and other characteristics. Hitachi bears no responsibility for failure or damage when used beyond the guaranteed ranges. Even within the guaranteed ranges, consider normally foreseeable failure rates or failure modes in semiconductor devices and employ systemic measures such as fail-safes, so that the equipment incorporating Hitachi product does not cause bodily injury, fire or other consequential damage due to operation of the Hitachi product.
5. This product is not designed to be radiation resistant.
6. No one is permitted to reproduce or duplicate, in any form, the whole or part of this document without written approval from Hitachi.
7. Contact Hitachi's sales office for any questions regarding this document or Hitachi semiconductor products.

IMPORTANT INFORMATION

READ FIRST

- **READ** this user's manual before using this emulator product.
- **KEEP the user's manual handy for future reference.**

Do not attempt to use the emulator product until you fully understand its mechanism.

Emulator Product:

Throughout this document, the term "emulator product" shall be defined as the following products produced only by Hitachi, Ltd. excluding all subsidiary products.

- Emulator station
- PC interface board
- User system interface board
- Cable

The user system or a host computer is not included in this definition.

Purpose of the Emulator Product:

This emulator product is a software and hardware development tool for systems employing the Hitachi microcomputer HD64F7058 (hereafter referred to as MCU). This emulator product must only be used for the above purpose.

Limited Applications:

This emulator product is not authorized for use in MEDICAL, atomic energy, aeronautical or space technology applications without consent of the appropriate officer of a Hitachi sales company. Such use includes, but is not limited to, use in life support systems. Buyers of this emulator product must notify the relevant Hitachi sales offices before planning to use the product in such applications.

Improvement Policy:

Hitachi, Ltd. (including its subsidiaries, hereafter collectively referred to as Hitachi) pursues a policy of continuing improvement in design, performance, and safety of the emulator product. Hitachi may change, wholly or partially, the specifications, design, user's manual, and other documentation at any time without notice.

Target User of the Emulator Product:

This emulator product should only be used by those who have carefully read and thoroughly understood the information and restrictions contained in the user's manual. Do not attempt to use the emulator product until you fully understand its mechanism.

It is highly recommended that first-time users be instructed by users that are well versed in the operation of the emulator product.

LIMITED WARRANTY

Hitachi warrants its emulator products to be manufactured in accordance with published specifications and free from defects in material and/or workmanship. Hitachi, at its option, will repair or replace any emulator products returned intact to the factory, transportation charges prepaid, which Hitachi, upon inspection, determine to be defective in material and/or workmanship. The foregoing shall constitute the sole remedy for any breach of Hitachi's warranty. See the Hitachi warranty booklet for details on the warranty period. This warranty extends only to you, the original Purchaser. It is not transferable to anyone who subsequently purchases the emulator product from you. Hitachi is not liable for any claim made by a third party or made by you for a third party.

DISCLAIMER

HITACHI MAKES NO WARRANTIES, EITHER EXPRESS OR IMPLIED, ORAL OR WRITTEN, EXCEPT AS PROVIDED HEREIN, INCLUDING WITHOUT LIMITATION THEREOF, WARRANTIES AS TO MARKETABILITY, MERCHANTABILITY, FITNESS FOR ANY PARTICULAR PURPOSE OR USE, OR AGAINST INFRINGEMENT OF ANY PATENT. IN NO EVENT SHALL HITACHI BE LIABLE FOR ANY DIRECT, INCIDENTAL OR CONSEQUENTIAL DAMAGES OF ANY NATURE, OR LOSSES OR EXPENSES RESULTING FROM ANY DEFECTIVE EMULATOR PRODUCT, THE USE OF ANY EMULATOR PRODUCT, OR ITS DOCUMENTATION, EVEN IF ADVISED OF THE POSSIBILITY OF SUCH DAMAGES. EXCEPT AS EXPRESSLY STATED OTHERWISE IN THIS WARRANTY, THIS EMULATOR PRODUCT IS SOLD "AS IS", AND YOU MUST ASSUME ALL RISK FOR THE USE AND RESULTS OBTAINED FROM THE EMULATOR PRODUCT.

State Law:

Some states do not allow the exclusion or limitation of implied warranties or liability for incidental or consequential damages, so the above limitation or exclusion may not apply to you. This warranty gives you specific legal rights, and you may have other rights which may vary from state to state.

The Warranty is Void in the Following Cases:

Hitachi shall have no liability or legal responsibility for any problems caused by misuse, abuse, misapplication, neglect, improper handling, installation, repair or modifications of the emulator product without Hitachi's prior written consent or any problems caused by the user system.

All Rights Reserved:

This user's manual and emulator product are copyrighted and all rights are reserved by Hitachi. No part of this user's manual, all or part, may be reproduced or duplicated in any form, in hard-copy or machine-readable form, by any means available without Hitachi's prior written consent.

Other Important Things to Keep in Mind:

1. Circuitry and other examples described herein are meant merely to indicate the characteristics and performance of Hitachi's semiconductor products. Hitachi assumes no responsibility for any intellectual property claims or other problems that may result from applications based on the examples described herein.
2. No license is granted by implication or otherwise under any patents or other rights of any third party or Hitachi.

Figures:

Some figures in this user's manual may show items different from your actual system.

Limited Anticipation of Danger:

Hitachi cannot anticipate every possible circumstance that might involve a potential hazard. The warnings in this user's manual and on the emulator product are therefore not all inclusive. Therefore, you must use the emulator product safely at your own risk.

SAFETY PAGE

READ FIRST

- **READ** this user's manual before using this emulator product.
- **KEEP** the user's manual handy for future reference.

Do not attempt to use the emulator product until you fully understand its mechanism.

DEFINITION OF SIGNAL WORDS



This is the safety alert symbol. It is used to alert you to potential personal injury hazards. Obey all safety messages that follow this symbol to avoid possible injury or death.



DANGER indicates an imminently hazardous situation which, if not avoided, will result in death or serious injury.



WARNING indicates a potentially hazardous situation which, if not avoided, could result in death or serious injury.



CAUTION indicates a potentially hazardous situation which, if not avoided, may result in minor or moderate injury.



CAUTION used without the safety alert symbol indicates a potentially hazardous situation which, if not avoided, may result in property damage.

NOTE emphasizes essential information.

WARNING

Observe the precautions listed below. Failure to do so will result in a FIRE HAZARD and will damage the user system and the emulator product or will result in PERSONAL INJURY. The USER PROGRAM will be LOST.

- 1. Carefully handle the emulator product to prevent receiving an electric shock because the emulator product has a DC power supply. Do not repair or remodel the emulator product by yourself for electric shock prevention and quality assurance.**
- 2. Always switch OFF the emulator and user system before connecting or disconnecting any CABLES or PARTS.**
- 3. Always before connecting, make sure that pin 1 on both sides are correctly aligned.**
- 4. Supply power according to the power specifications and do not apply an incorrect power voltage. Use only the provided AC power cable. Use only the specified type of fuse.**

Warnings on Emulator Usage

Warnings described below apply as long as you use this emulator. Be sure to read and understand the warnings below before using this emulator. Note that these are the main warnings, not the complete list.

WARNING

Always switch OFF the emulator and user system before connecting or disconnecting any CABLES or PARTS. Failure to do so will result in a FIRE HAZARD and will damage the user system and the emulator product or will result in PERSONAL INJURY. The USER PROGRAM will be LOST.

CAUTION

Place the emulator station and evaluation chip board so that the trace cables are not bent or twisted. A bent or twisted cable will impose stress on the user interface leading to connection or contact failure. Make sure that the emulator station is placed in a secure position so that it does not move during use nor impose stress on the user interface.

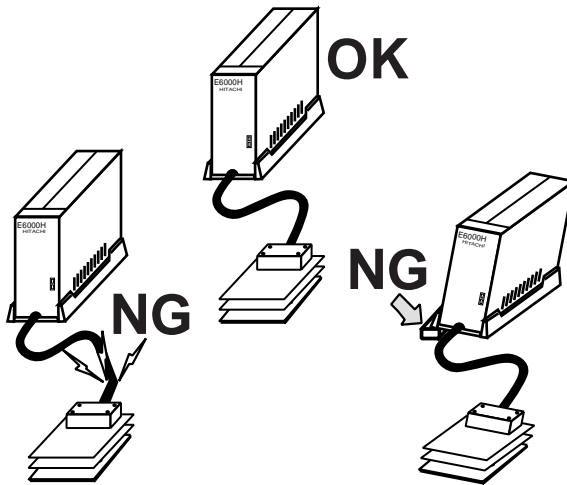

CAUTION

This equipment has been tested and found to comply with the limits for a Class A digital device, pursuant to part 15 of the FCC Rules. These limits are designed to provide reasonable protection against harmful interference when the equipment is operated in a commercial environment. This equipment generates, uses, and can radiate radio frequency energy and, if not installed and used in accordance with the instruction manual, may cause harmful interference to radio communications. Operation of this equipment in a residential area is likely to cause harmful interference in which case the user will be required to correct the interference at his own expense.

Preface

Thank you for purchasing the emulator for the Hitachi microcomputer SH7058.

CAUTION

Read section 3, Preparation before Use before using the emulator product. Incorrect operation or connection will damage the user system, the emulator product, and the user program.

The SH7058 E6000H emulator (hereinafter referred to as the emulator) is an efficient software and hardware development tool for systems based on Hitachi microcomputer SH7058. The emulator is operated by using the Hitachi Debugging Interface (hereafter referred to as HDI). This interface program is supported by Windows[®] 98, Windows[®] Me, Windows NT[®] 4.0, and Windows[®] 2000.

This manual describes the emulator functions and operations. Please read this manual carefully before use, in particular section 1.1, Notes on Usage. A CD-R for the E6000H emulator is packaged with the emulator. For details, refer to section 3, Preparation before Use.

Related Manuals:

Description Notes on Using the PC Card Interface (HS6000EIP01H) for the E6000/E8000 Emulator

Description Notes on Using the PCI Interface Board (HS6000EIC01H) for the E6000/E8000 Emulator

Description Notes on Using the PCI Interface Board (HS6000EIC02H) for the E6000/E8000 Emulator

Description Notes on Using the LAN Adapter (HS6000ELN01H) for the E6000/E8000 Emulator

Description Notes on Using the USB Adapter (HS6000EIU01H) for the E6000/E8000 Emulator

Hitachi Embedded Workshop User's Manual

SuperH™ RISC engine C/C++ Compiler User's Manual

SuperH™ RISC engine Assembler User's Manual

H Series Linkage Editor, Librarian, Object Converter User's Manual

Hitachi Debugging Interface User's Manual

Hardware Manual supporting each MCU

Programming Manual supporting each MCU

- Notes:
1. IBM PC is a registered trademark of International Business Machines Corporation.
 2. Microsoft[®], Windows[®], and Windows NT[®] 4.0 are registered trademarks of Microsoft Corporation in the United States and/or in other countries.
 3. Pentium[®] is a registered trademark of Intel Corporation in the United States.

- Abbreviation:
1. Windows[®] 98 is an abbreviation for Microsoft[®] Windows[®] 98 operating system.
 2. Windows[®] Me is an abbreviation for Microsoft[®] Windows[®] Millennium Edition.
 3. Windows NT[®] 4.0 is an abbreviation for Microsoft[®] Windows NT[®] 4.0 operating system.
 4. Windows[®] 2000 is an abbreviation for Microsoft[®] Windows[®] 2000 operating system.

Contents

Section 1	Overview	1
1.1	Notes on Usage	4
1.2	Environmental Conditions.....	5
1.3	Components	7
1.3.1	Emulator.....	7
1.3.2	Options.....	8
Section 2	Components.....	9
2.1	Emulator Hardware Components	9
2.1.1	E6000H Station Components	10
2.1.2	Evaluation Chip Board Configuration.....	12
2.1.3	Configuration of User System Interface Board	14
2.2	Configuration of the Provided CD-R	15
2.3	System Configuration.....	18
2.3.1	System Configuration Using a PC Interface Board.....	18
Section 3	Preparation before Use	21
3.1	Description on Emulator Usage	21
3.2	Installing the Acrobat® Reader.....	22
3.3	Emulator Connection.....	22
3.3.1	Connecting the User System	22
3.3.2	Connecting the User System Interface Board.....	23
3.3.3	Connecting the External Probe.....	24
3.3.4	Selecting the Clock	25
3.3.5	Connecting the System Ground.....	27
3.3.6	PC Interface Board Specifications (PCI Bus Specifications).....	29
Section 4	Tutorial	33
4.1	Introduction.....	33
4.2	Running the HDI	34
4.3	Setting the Memory Map.....	37
4.4	Downloading	39
4.4.1	Downloading the Sample Program.....	39
4.4.2	Displaying the Source Program.....	40
4.5	Setting the Program Counter Breakpoints	42
4.6	Executing the Program.....	43

4.7	Reviewing Breakpoints	45
4.8	Viewing Memory	46
4.9	Watching Variables	48
4.10	Stepping Through a Program	51
	4.10.1 Executing [Step In] Command	53
	4.10.2 Executing [Step Out] Command	54
	4.10.3 Executing [Step Over] Command	57
4.11	Displaying Local Variables	59
4.12	Saving and Loading the Session	60
Section 5 Emulator Functions		61
5.1	Introduction	61
5.2	Setting the Emulator's Operating Conditions	62
	5.2.1 [Configuration] Dialog Box	63
5.3	Program Execution	80
	5.3.1 Execution	80
5.4	Display of Cause for Termination and Operating Status	81
5.5	Step Functions	83
	5.5.1 Step Execution	83
	5.5.2 Accepting Interrupts during Step Execution	83
5.6	Break Functions	84
	5.6.1 On-Chip Break	86
	5.6.2 On-Chip Sequential Break	97
	5.6.3 On-Emulator Break	101
	5.6.4 Software Break	113
	5.6.5 Forced Break	116
	5.6.6 Break Due to Trace-Buffer Overflow	117
5.7	Realtime Trace Functions	118
	5.7.1 Trace Acquisition Condition	118
	5.7.2 External Bus Trace Timing	136
	5.7.3 Trace Display	137
	5.7.4 Trace Search Functions	140
	5.7.5 Trace Find Functions	150
5.8	Measurement of Execution Time	151
	5.8.1 Measuring Normal Execution Time	151
	5.8.2 Measuring Execution Time between Satisfaction of Specified Conditions	152
5.9	Performance Analysis Function	155
	5.9.1 Measuring with E6000H Station Function	155
	5.9.2 Profiling Function	168
5.10	Displaying Various Information	173

5.11	Trigger Output.....	176
5.12	Stack Trace Function.....	177
5.13	Displaying and Updating the Contents of Memory	179
5.13.1	Displaying and Updating the Contents of Memory during Execution.....	179
5.13.2	Overview of Auto-Update Memory Function	180
5.13.3	Setting Auto update Memory	181
5.13.4	Displaying the Auto update Memory	181
5.14	Input Format.....	183
5.14.1	Entering Masks	183
5.15	[Source] Window Expanded Function	184
5.15.1	Setting BP Column.....	184
Section 6 Command Line		185
6.1	List Format.....	185
6.1.1	Description.....	185
6.1.2	Format.....	185
6.1.3	Parameter Type Input.....	186
6.1.4	Examples.....	186
6.2	List of Commands	187
6.2.1	ANALYSIS (AN).....	191
6.2.2	ANALYSIS RANGE _{<i>n</i>} (AR _{<i>n</i>})	192
6.2.3	ANALYSIS_RANGE_DELETE _{<i>n</i>} (AD _{<i>n</i>}).....	197
6.2.4	On-Chip Break Commands (BC, BC _{<i>n</i>} , BCC, BCE, BCR)	198
6.2.5	On-Emulator Break Commands (BE, BE _{<i>n</i>} , BEC, BEE)	204
6.2.6	Software Break Commands (BS, BSC, BSE)	210
6.2.7	CLOCK (CK).....	211
6.2.8	CONFIGURATION_PLATFORM (CP)	212
6.2.9	DEVICE_TYPE (DE).....	214
6.2.10	ERAM (EM)	215
6.2.11	FLASH_MEMORY (FM).....	217
6.2.12	MAP_DISPLAY (MA)	218
6.2.13	MODE (MO).....	219
6.2.14	REFRESH (RF)	220
6.2.15	TEST_EMULATOR (TE)	221
6.2.16	TIMER (TI)	222
6.2.17	TRACE_ACQUISITION (TA, TA _{<i>n</i>}).....	223
6.2.18	TRACE_ALL (TL)	230
6.2.19	TRACE_COMPARE (TC)	232
6.2.20	TRACE_SAVE (TV)	233
6.2.21	TRACE_SEARCH (TS)	234

6.2.22	USER_SIGNALS (US)	239
Section 7 Error Messages 241		
7.1	Error Messages of the Emulator	241
7.1.1	Error messages at Emulator Initiation	241
7.1.2	Error messages during Emulation	242
7.2	HDI Error Messages Related to the Emulator	243
7.3	Error Messages for the LAN Driver	243
Appendix A User System Interface Circuit 245		
A.1	User System Interface Circuit	245
Appendix B Emulator External Dimensions and Mass 253		
Appendix C Connecting the Emulator to the User System 255		
C.1	Connecting to the User System	255
C.1.1	Installing IC Socket	256
C.1.2	Connection Using the HS7058ECF61H	256
C.1.3	Connection Using the Dedicated Connector	260
C.2	Pin Arrangement on the User System Interface Connector	263
C.3	Precautions on Connecting the User System	271
Appendix D MCU Internal Module Support 273		
D.1	Memory Space	273
D.1.1	Internal Flash Memory Area	273
D.1.2	Internal I/O Area	273
D.1.3	External Memory Area	273
D.1.4	Emulation RAM Area	273
D.2	Low Power-consumption Mode (Sleep, Software Standby, and Hardware Standby)	274
D.2.1	Hardware Standby Mode	274
D.2.2	Sleep and Software Standby Modes	274
D.3	Interrupts	274
D.4	Control Input Signals (_RES, _BREQ, and _WAIT)	275
D.5	Watchdog Timer (WDT)	275
D.6	A/D Converter	275
D.7	Emulator Status and Internal Modules	276
Appendix E Notes on Debugging 277		
E.1	Notes on HDI	277
E.1.1	Memory Compare Function	277

E.1.2	Source-Level Execution	277
E.1.3	Watch.....	277
E.1.4	Symbol Description for Expression	278
E.1.5	Register Function	278
E.1.6	Session File Function	278
E.1.7	Command Line Window	278
E.1.8	[I/O Registers] Window	279
E.1.9	Bit Field	279
E.1.10	Line Assembly	279
E.1.11	Usage with Another HDI.....	280
E.1.12	Operation During Accessing Files	280
E.1.13	Moving Source File Position after Creating Load Module	280
E.2	User System Interface	280
E.3	On-Emulator Break Functions.....	281
E.3.1	Setting Address Bus and Data Bus Conditions	281
E.4	Sequential Trace Function.....	282
E.5	Differences between the Emulator and the MCU	282
E.6	Step Function	283
E.7	Displaying and Modifying the Contents of Memory	283
E.7.1	Suspension of Program Execution: Reference Periods	283
E.7.2	Parallel Access.....	283
E.7.3	External Memory Area Access in Single-Chip Mode	283
Appendix F Diagnostic Test Procedure		285
F.1	System Set-Up for Diagnostic Program Execution	285
F.2	Test Item of the Diagnostic Program.....	287
F.3	Diagnostic Test Procedure Using the Diagnostic Program	288

Figures

Figure 1.1	Configuration of the Emulator for the SH7058	2
Figure 2.1	Emulator Hardware Components.....	9
Figure 2.2	E6000H Station: Front Panel.....	10
Figure 2.3	E6000H Station: Rear Panel.....	11
Figure 2.4	Evaluation Chip Board (HS7058EPH60H)	12
Figure 2.5	Configuration of User System Interface Board.....	14
Figure 2.6	System Configuration Using a PC Interface Board	18
Figure 2.7	System Configuration Using a LAN Adapter	19
Figure 2.8	System Configuration Using a USB Adapter.....	19
Figure 3.1	Emulator Preparation Flowchart.....	21
Figure 3.2	Connecting the User System Interface Board	23
Figure 3.3	External Probe Connector.....	24
Figure 3.4	Installing the Crystal Oscillator	26
Figure 3.5	Connecting the System Ground	27
Figure 3.6	Connecting the Frame Ground.....	28
Figure 3.7	Installing the PCI Interface Board	30
Figure 3.8	Connecting the E6000H Station to the PC Interface Board.....	31
Figure 4.1	[Start] Menu	34
Figure 4.2	HDI Window	36
Figure 4.3	[ERam] Page (before Setting).....	37
Figure 4.4	Allocating the Emulation Memory	38
Figure 4.5	[Load Program] Dialog Box.....	39
Figure 4.6	[HDI] Dialog Box.....	39
Figure 4.7	[Open] Dialog Box	40
Figure 4.8	[Source] Window (Displaying the Source Program)	41
Figure 4.9	[Source] Window (Setting a PC Breakpoint).....	42
Figure 4.10	[Source] Window (Break State).....	43
Figure 4.11	[System Status] Window	44
Figure 4.12	[Breakpoints] Window	45
Figure 4.13	[Open Memory Window] Dialog Box	46
Figure 4.14	[Long Memory] Window.....	47
Figure 4.15	[Instant Watch] Dialog Box.....	48
Figure 4.16	[Watch Window] Window (Displaying the Array).....	49
Figure 4.17	[Add Watch] Dialog Box.....	49
Figure 4.18	[Watch Window] Window (Displaying the Variable)	50
Figure 4.19	[Watch Window] Window (Displaying Array Elements).....	50
Figure 4.20	[Source] Window (Step Execution).....	52
Figure 4.21	[Source] Window (Step In).....	53

Figure 4.22	[Source] Window (Step Out).....	54
Figure 4.23	[Watch Window] Display Example (1)	55
Figure 4.24	[Source] Window (Step Out → Step In).....	55
Figure 4.25	[Watch Window] Display Example (2)	56
Figure 4.26	[Source] Window (Before Step Over Execution)	57
Figure 4.27	[Source] Window (After Step Over Execution).....	58
Figure 4.28	[Watch Window] Display Example (3)	58
Figure 4.29	[Locals] Window	59
Figure 4.30	[Locals] Window (Displaying Array a Elements)	59
Figure 5.1	[Configuration] Dialog Box.....	63
Figure 5.2	[Configuration] Dialog Box ([General] Page).....	65
Figure 5.3	[Configuration] Dialog Box ([ERam] Page).....	68
Figure 5.4	[User] Mode in [ERam] Page	70
Figure 5.5	Diagram for Emulation Memory in [User] Mode	71
Figure 5.6	Allocation to ERAM0 and ERAM1 Display	72
Figure 5.7	Diagram for Allocation to ERAM0 and ERAM1	73
Figure 5.8	Allocation to ERAM4 and ERAM0 Display	74
Figure 5.9	Diagram for Allocation to ERAM4 and ERAM0	75
Figure 5.10	Automatically Copying ROM Contents to ERAM0	76
Figure 5.11	Releasing ERAM0 and ERAM1	77
Figure 5.12	Selection of Automatic Downloading of ERAM contents to ROM Area (On-chip Flash Memory)	78
Figure 5.13	Selection of the [Auto allocate for software break] Mode in [ERam] Page.....	79
Figure 5.14	[Breakpoints] Window	84
Figure 5.15	[Breakpoint Properties] Dialog Box ([On Chip Break] Page).....	87
Figure 5.16	[On Chip Break Channel 8] Dialog Box ([Address] Page).....	89
Figure 5.17	[On Chip Break Channel 8] Dialog Box ([Data] Page)	90
Figure 5.18	[On Chip Break Channel 8] Dialog Box ([Bus State] Page).....	92
Figure 5.19	[On Chip Break Channel 8] Dialog Box ([Count] Page)	94
Figure 5.20	[On Chip Break Channel 8] Dialog Box ([Action] Page).....	95
Figure 5.21	[On Chip Break Reset] Dialog Box ([Reset] Page)	96
Figure 5.22	[Breakpoint Properties] Dialog Box ([On Chip Break] Page).....	98
Figure 5.23	Selecting 4 for [Sequential Break].....	99
Figure 5.24	Selecting 7 for [Sequential Break].....	100
Figure 5.25	[Breakpoint Properties] Dialog Box ([On Emulator Break] Page).....	102
Figure 5.26	[On Emulator Break Channel 1] Dialog Box ([Address] Page).....	103
Figure 5.27	[On Emulator Break Channel 1] Dialog Box ([Data] Page)	105
Figure 5.28	[On Emulator Break Channel 1] Dialog Box ([Bus/Area] Page).....	107
Figure 5.29	[On Emulator Break Channel 1] Dialog Box ([Probe] Page)	109
Figure 5.30	[On Emulator Break Channel 1] Dialog Box ([Interrupt] Page).....	110

Figure 5.31	[On Emulator Break Channel 1] Dialog Box ([Count] Page)	112
Figure 5.32	Example of a Software Break Instruction	113
Figure 5.33	[Breakpoint Properties] Dialog Box ([Software Break] Page)	114
Figure 5.34	[Software Break] Dialog Box ([Address] Page)	115
Figure 5.35	[Trace Acquisition Properties] Dialog Box ([Other] Page)	117
Figure 5.36	Trace Acquisition in Free Trace Mode	120
Figure 5.37	Trace Acquisition in Trace-Stop Mode	120
Figure 5.38	[Trace Acquisition Properties] Dialog Box	122
Figure 5.39	[Action] Page	124
Figure 5.40	[Delay] Page	127
Figure 5.41	[Trace Acquisition Properties] Dialog Box (Sequential Trace Stop)	129
Figure 5.42	[Trace Acquisition Properties] Dialog Box ([Other] Page)	130
Figure 5.43	Setting the Subroutine Trace Mode ([Action] Page)	131
Figure 5.44	Example of Conditional Trace Mode	132
Figure 5.45	Setting the Conditional Trace Mode ([Action] Page)	134
Figure 5.46	[Trace Acquisition Properties] Dialog Box ([Other] Page)	135
Figure 5.47	Tracing External Probe Signal	137
Figure 5.48	[Trace Filter Properties] Dialog Box ([General] Page)	138
Figure 5.49	[Trace] Window	138
Figure 5.50	[Trace Filter Properties] Dialog Box ([General] Page)	141
Figure 5.51	[Trace Filter Properties] Dialog Box ([Address] Page)	143
Figure 5.52	[Trace Filter Properties] Dialog Box ([Bus/Area] Page)	144
Figure 5.53	[Trace Filter Properties] Dialog Box ([Interrupt] Page)	146
Figure 5.54	[Trace Filter Properties] Dialog Box ([Time] Page)	148
Figure 5.55	[Trace Find Properties] Dialog Box ([General] Page)	150
Figure 5.56	[System Status] Window (Display of Execution Time)	151
Figure 5.57	[Breakpoint Properties] Dialog Box ([On Chip Break] Page)	153
Figure 5.58	[Performance Analysis] Window	155
Figure 5.59	Example of Time Of Specified Range Measurement	157
Figure 5.60	Example of Start Point To End Point Measurement	158
Figure 5.61	Example of Start Range To End Range Measurement	159
Figure 5.62	[Performance Analysis Conditions] Dialog Box	161
Figure 5.63	[Performance Analysis Properties] Dialog Box	163
Figure 5.64	[Performance Analysis] Window ([Value] Selected)	166
Figure 5.65	[Performance Analysis] Window (Results of Execution Time Ratios)	167
Figure 5.66	[Profile-List] Window	169
Figure 5.67	[Profile-Tree] Window	170
Figure 5.68	[Profile-Chart] Window (after User Program Execution)	171
Figure 5.69	[System Status] Window	173
Figure 5.70	Pulse Output Timing	177

Figure 5.71	[Stack Trace] Window.....	177
Figure 5.72	[Stack Trace Setting] Dialog Box.....	178
Figure 5.73	[AUM] Window	181
Figure 5.74	[Auto-update Memory -Edit-] Dialog Box	182
Figure A.1	Basic Bus Cycle (Software Wait).....	246
Figure A.2	User System Interface Circuits (1)	247
Figure A.2	User System Interface Circuits (2)	248
Figure A.2	User System Interface Circuits (3)	249
Figure A.2	User System Interface Circuits (4)	250
Figure A.2	User System Interface Circuits (5)	251
Figure A.2	User System Interface Circuits (6)	252
Figure B.1	External Dimensions and Mass of the Emulator.....	253
Figure C.1	Connection Using the HS7058ECF61H.....	257
Figure C.2	Restrictions on Component Installation	258
Figure C.3	Recommended Mount Pad Dimensions of the User System IC Socket.....	259
Figure C.4	Connection Using the Dedicated Connector	261
Figure C.5	Size Restrictions for the Installed Components.....	261
Figure C.6	Location for Mounting the Connector in the User System.....	262
Figure F.1	[Misc] Page	286

Tables

Table 1.1	Environmental Conditions	5
Table 1.2	Operating Environment.....	6
Table 1.3	Emulator Components (HS7058EPH60H)	7
Table 1.4	Optional Component Specifications	8
Table 2.1	Contents of CD-R	16
Table 3.1	PC Interface Board Specifications	29
Table 4.1	[General] Page in the [Configuration] Dialog Box Setting Example: Configuration of the [General] Page	35
Table 4.2	Step Command.....	51
Table 5.1	Emulator Functions.....	61
Table 5.2	Setting the Emulator's Operating Conditions	62
Table 5.3	[Configuration] Dialog Box.....	64
Table 5.4	[General] Page	66
Table 5.5	[ERam] Page.....	69
Table 5.6	Program Execution	80
Table 5.7	Causes for Termination.....	81
Table 5.8	Operating Status Display	82
Table 5.9	Step Execution	83
Table 5.10	Break Functions	85
Table 5.11	On-Chip Break Conditions	86
Table 5.12	[On Chip Break] Dialog Box Options	88
Table 5.13	[Address] Page Options	89
Table 5.14	[Data] Page Options.....	91
Table 5.15	[Bus State] Page Options	92
Table 5.16	[Count] Page Options	94
Table 5.17	[Action] Page Options	95
Table 5.18	[On Chip Break Reset] Dialog Box Option	96
Table 5.19	On-Chip Sequential Break Modes (On Chip Break Channel 1 to 8)	97
Table 5.20	[Sequential Break] Options (On Chip Break Channel 1 to 8).....	99
Table 5.21	On-Emulator Break Conditions	101
Table 5.22	Options in the [On Emulator Break] Page	103
Table 5.23	[Address] Page Options	104
Table 5.24	[Data] Page Options.....	106
Table 5.25	[Bus/Area] Page Options	107
Table 5.26	[Probe] Page Options.....	109
Table 5.27	[Interrupt] Page Options	110
Table 5.28	[Count] Page Options	112
Table 5.29	[Software Break] Page Options	115

Table 5.30	[Software Break] Dialog Box Option	116
Table 5.31	Trace Acquisition Modes.....	119
Table 5.32	Trace Stop Conditions	121
Table 5.33	[Trace Acquisition Properties] Dialog Box Options.....	123
Table 5.34	[Action] Page Options	125
Table 5.35	[Trace Acquisition Condition Channel] Dialog Box Pages	126
Table 5.36	[Delay] Page Options.....	127
Table 5.37	Conditional Trace Modes	133
Table 5.38	[Time measurement unit] Group Box Option	136
Table 5.39	Trace Information Items and Display Format in [Trace] Window.....	139
Table 5.40	Trace Search Functions.....	140
Table 5.41	[General] Page Option	141
Table 5.42	Trace Search Conditions and Pages in the [Trace Filter Properties] Dialog Box	142
Table 5.43	[Address] Page Options	143
Table 5.44	[Bus/Area] Page Options	144
Table 5.45	[Interrupt] Page Options	147
Table 5.46	[Time] Page Options.....	149
Table 5.47	Measurement Modes.....	156
Table 5.48	Modes that are Available in the [Performance 1 to 8] Dialog Boxes.....	159
Table 5.49	[Performance Analysis Conditions] Dialog Box Options	162
Table 5.50	Setting Value for Measurement Method	164
Table 5.51	Menu Items for Displaying the Results.....	166
Table 5.52	Display Format of Results When [Value] is Selected.....	166
Table 5.53	Display Format of Results When [Graph] is Selected	167
Table 5.54	Window Provided by the Profiling Data Measurement Function	168
Table 5.55	Conditions for Starting or Ending the Profiling Data Measurement	171
Table 5.56	Limitations on Enabled Profiling Function.....	172
Table 5.57	[System Status] Window Configuration.....	174
Table 5.58	[Session] Sheet Configuration	174
Table 5.59	[Platform] Sheet Configuration.....	175
Table 5.60	[Memory] Sheet Configuration.....	176
Table 5.61	[Events] Sheet Configuration.....	176
Table 5.62	[Stack Trace] Window Options	178
Table 5.63	Options in the Pop-up Menu	178
Table 5.64	[Stack Trace Setting] Dialog Box Options	179
Table 5.65	Access Types for Displaying and Modifying Contents of Memory	179
Table 5.66	Characteristics of Displaying and Modifying Contents of Memory.....	180
Table 5.67	Dialog Boxes for Setting Auto-Update Memory Items.....	181
Table 5.68	Address Mask Specification	183
Table 6.1	List of Commands.....	187

Table 7.1	Error Messages at Initiation.....	241
Table 7.2	Error Messages during Emulation	242
Table 7.3	HDI Error Messages	243
Table A.1	Bus Timing when Using the Emulator (Bus Clock: 20.0 MHz)	245
Table C.1	User System Interface Board and User Interfaces	255
Table C.2	Pin Arrangement on HS7058EPH60H.....	263
Table D.1	Emulator State and Operation of Internal Modules.....	276
Table E.1	Watchdog Timer Registers	279
Table E.2	Delay Time for Signal Connected via the Evaluation Chip Board	280
Table E.3	Initial Values of Registers in the MCU and the Emulator	282
Table E.4	Suspension of Program Execution: Reference Values.....	283
Table E.5	Measurement Environment.....	283

Section 1 Overview

This system is an efficient software and hardware development support tool for application systems using the HD64F7058 (hereafter referred to as SH7058) microcomputer developed by Hitachi, Ltd.

As peripheral functions for use with its high-speed CPU, the SH7058 incorporates a floating-point unit (FPU), direct memory access controller (DMAC), advanced timer unit (ATU-II), advanced pulse unit (APU), watchdog timer (WDT), compare-match timer (CMT), serial communications interface (SCI), Hitachi controller area network (HCAN), A/D converter, interrupt controller (INTC), I/O ports, memory, etc.

The emulator operates in place of the SH7058 and performs realtime emulation of the user system. The emulator also provides functions for efficient hardware and software debugging.

The emulator package consists of the SH7058 E6000H station and a user system interface board. The emulator is connected to the user system via the dedicated connector on the evaluation chip board or the user system interface board.

PC interface (option) includes a PC interface board (PCI bus and PC card bus; installed on the host computer), a LAN adapter (connected with the network), and a USB adapter (connected with the USB interface). By connecting the emulator to the host computer via those interfaces, the SH7058 E6000H Hitachi Debugging Interface (hereafter referred to as HDI) can be used for debugging. For details on PC interface boards (available for PCI bus and PC card bus specifications), LAN adapter, and USB adapter, refer to their description notes.

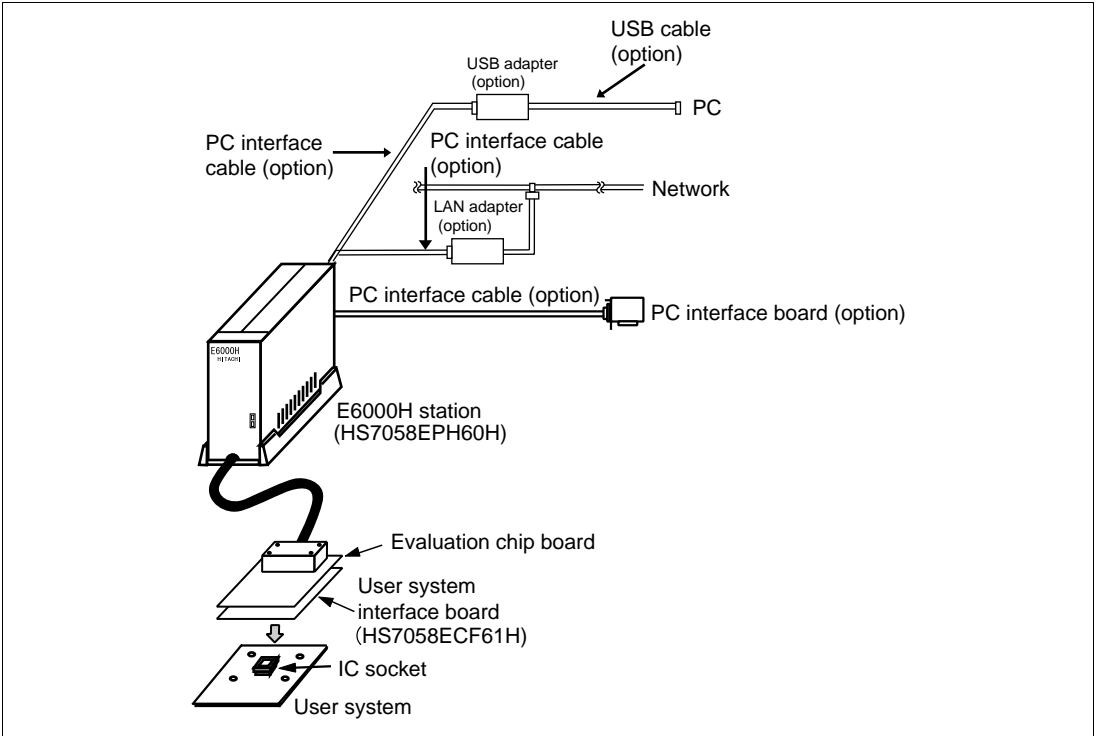

Figure 1.1 Configuration of the Emulator for the SH7058

The emulator provides the following features:

1. Realtime emulation of the MCU at 80 MHz
2. A wide selection of emulation commands, promoting efficient system development
3. On-line help functions to facilitate command usage without a manual
4. Efficient debugging enabled by variable break functions and a mass-storage trace memory (128-kcycles)
5. Parallel access with a command execution during emulation, for example
 - Trace data display
 - Emulation memory display and modification
6. Performance analysis
Measurement of subroutine execution time and count for evaluating the execution efficiency of user programs
7. A LAN adapter for connecting the emulator to a host computer via a LAN interface (10BASE-T or 100BASE-TX), allowing loading of the SH7058 E6000H Hitachi Debugging Interface into the host computer. This enables graphic display operations in a multi-window environment, and source-level debugging.
8. A USB adapter for connecting the emulator to a host computer via a USB interface, allowing loading of the SH7058 E6000H Hitachi Debugging Interface into the host computer. This enables graphic display operations in a multi-window environment, and source-level debugging.
9. A PC interface board (for the PCI bus or PC card bus) connected to the host computer through the PC interface cable. The HDI can be loaded into the host computer to enable:
 - Graphic display operations in a multi-window environment
 - Source-level debugging

Note: Ethernet[®] is a registered trademark of Xerox Corporation (USA).

1.1 Notes on Usage

CAUTION

READ the following warnings before using the emulator product. Incorrect operation will damage the user system and the emulator product. The USER PROGRAM will be LOST.

1. Check all components with the component list after unpacking the emulator.
2. Never place heavy objects on the casing.
3. Observe the following conditions in the area where the emulator is to be used:
 - Make sure that the internal cooling fans on the sides of the emulator must be at least 20 cm (8") away from walls or other equipment.
 - Keep out of direct sunlight or heat. Refer to section 1.2, Environmental Conditions.
 - Use in an environment with constant temperature and humidity.
 - Protect the emulator from dust.
 - Avoid subjecting the emulator to excessive vibration. Refer to section 1.2, Environmental Conditions.
4. Protect the emulator from excessive impacts and stresses.
5. Before using the emulator's power supply, check its specifications such as power voltage and frequency.
6. When moving the emulator, take care not to vibrate or otherwise damage it.
7. After connecting the cable, check that it is connected correctly. For details, refer to section 3, Preparation before Use.
8. Supply power to the emulator and connected parts after connecting all cables. Cables must not be connected or removed while the power is on.
9. For details on differences between the MCU and the emulator, refer to appendix E.5, Differences between the Emulator and the MCU.

1.2 Environmental Conditions

CAUTION

Observe the conditions listed in table 1.1 when using the emulator. The following environmental conditions must be satisfied, otherwise the user system and the emulator will not operate normally. The USER PROGRAM will be LOST.

Table 1.1 Environmental Conditions

Item	Specifications
Temperature	Operating: +10 to +35°C
	Storage: -10 to +50°C
Humidity	Operating: 35 to 80% RH, no condensation
	Storage: 35 to 80% RH, no condensation
Vibration	Operating: 2.45 m/s ² max.
	Storage: 4.9 m/s ² max.
	Transportation: 14.7 m/s ² max.
AC input power	Voltage: 100 V to 240 V AC
	Frequency: 50/60 Hz
	Power consumption: 75 W
Ambient gases	There must be no corrosive gases present.

Details of the operating environment are listed in table 1.2.

Table 1.2 Operating Environment

Item	Operating Environment
Host computer	IBM PCs and compatible machines that contain Pentium® III processors (800 MHz or faster is recommended)
Operating system	Windows® 98, Windows® Me, Windows NT® 4.0, or Windows® 2000
Minimum memory capacity for operation	32 Mbytes (more than twice the size of the load module is recommended)
Display	Resolution better than 800 × 600 (SVGA) is recommended
Empty space in a hard disk	Disk capacity required for installation: 40 Mbytes or more Take the swap area into account when ensuring that there is enough space on your system (more than four times the size of the memory is recommended).
Supported interfaces	PCI bus slot, PC card (PCMCIA), LAN adapter (conforming to IEEE802.3, with 10BASE-T or 100BASE-TX), USB adapter (conforming to V1.1)
Pointing device such as a mouse	A pointing device such as a mouse, which can be connected to the host computer and is supported by Windows® 98, Windows® Me, Windows NT® 4.0, and Windows® 2000
CD-ROM drive	Required for installing the emulator software or referring to the user's manual

1.3 Components

The emulator components are listed below. Check all components after unpacking. If any component is missing, contact the sales agency from which the emulator was purchased.

1.3.1 Emulator

Table 1.3 lists the emulator components.

Table 1.3 Emulator Components (HS7058EPH60H)

Classification	Item	Quantity	Remarks
Hardware	E6000H station	1	
	Trace cable	1	Connected to the emulator station
	SH7058 evaluation chip board	1	Two boards connected via a trace cable
	External probe	1	Probe input: four, RUN or break output: one Trigger output: one GND: two
	AC power cable	1	
Software	SH7058 E6000H emulator	1	CD-R HS7058EPH60SR
Manual	Description Notes on Using the SH7058 E6000H Emulator	1	HS7058EPH60HE-P(*)

Note: (*) indicates a manual revision.

1.3.2 Options

In addition to the E6000H station, the options listed in table 1.4 are also available. Refer to each option manual for details on these optional components.

Table 1.4 Optional Component Specifications

Item	Model Name	Specifications
User system interface board for the SH7058 (FP-256H)	HS7058ECF61H	For the SH7058 (FP-256H)
PCI interface board	HS6000EIC01H HS6000EIC02H	PCI bus
PC interface card	HS6000EIP01H	PC card bus
LAN adapter	HS6000ELN01H	<ul style="list-style-type: none">• TCP/IP communications protocol• 10BASE-T• 100BASE-TX
USB adapter	HS6000EIU01H	Conforms to V1.1

Section 2 Components

2.1 Emulator Hardware Components

The emulator consists of an E6000H station and an SH7058 evaluation chip board. By installing a user system interface board (option) on your host computer, the emulator can be connected in the same package as the device. PC interface (option) includes a PC interface board (PCI bus and PC card bus; installed on the host computer), a LAN adapter (connected with the network), and a USB adapter (connected with the USB interface). By connecting the emulator to the host computer via those interfaces, the SH7058 E6000H Hitachi Debugging Interface (hereafter referred to as HDI) can be used for debugging. For details on PC interface boards (available for PCI bus and PC card bus specifications), LAN adapter, and USB adapter, refer to their description notes.

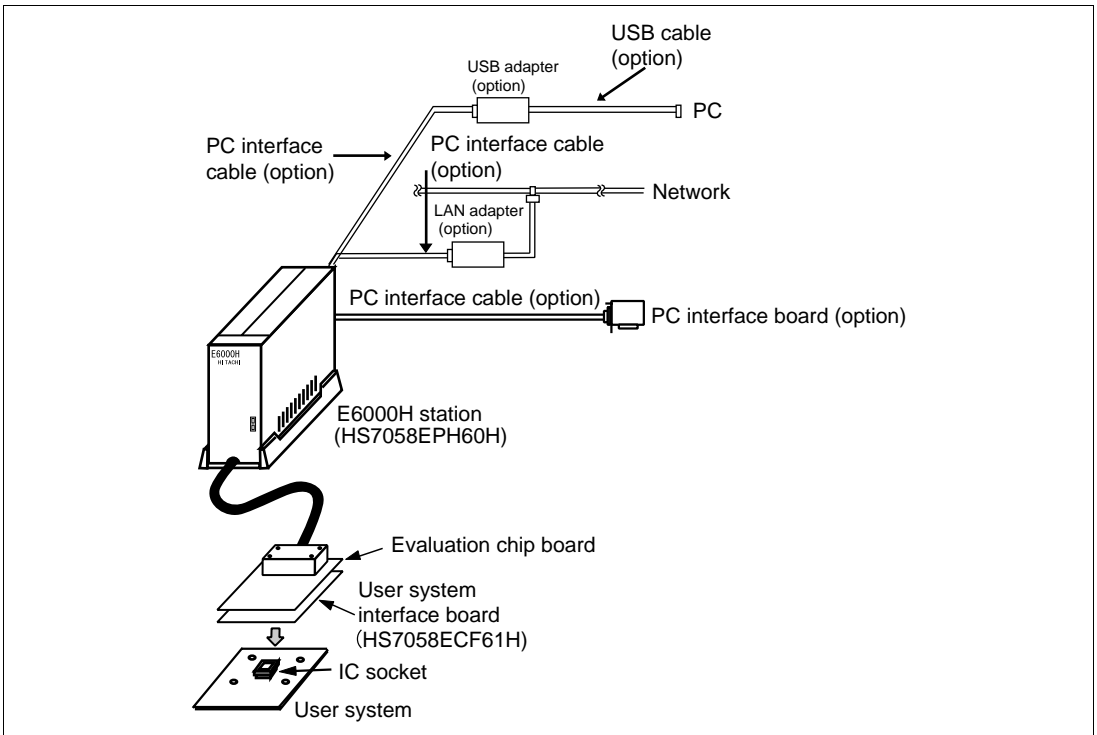

Figure 2.1 Emulator Hardware Components

2.1.1 E6000H Station Components

The names of the components on the front/rear panel of the E6000H station are listed below.

Front Panel:



Figure 2.2 E6000H Station: Front Panel

1. POWER lamp: Is lit up while the E6000H station is supplied with power.
2. RUN lamp: Is lit up while the user program is running.

Rear Panel:



Figure 2.3 E6000H Station: Rear Panel

- | | |
|-----------------------------------|--|
| (a) Power switch: | Turning this switch to I (input) supplies power to the emulator (E6000H station and evaluation chip board). |
| (b) AC power connector: | For an AC 100-V to 240-V power supply. |
| (c) PC interface cable connector: | For the PC interface cable that connects the host computer to the E6000H station. A PC interface board, PC card interface, LAN adapter, or USB adapter can be connected. Marked PC/IF. |

2.1.2 Evaluation Chip Board Configuration

The names of the components on the evaluation chip board of the emulator are listed below.

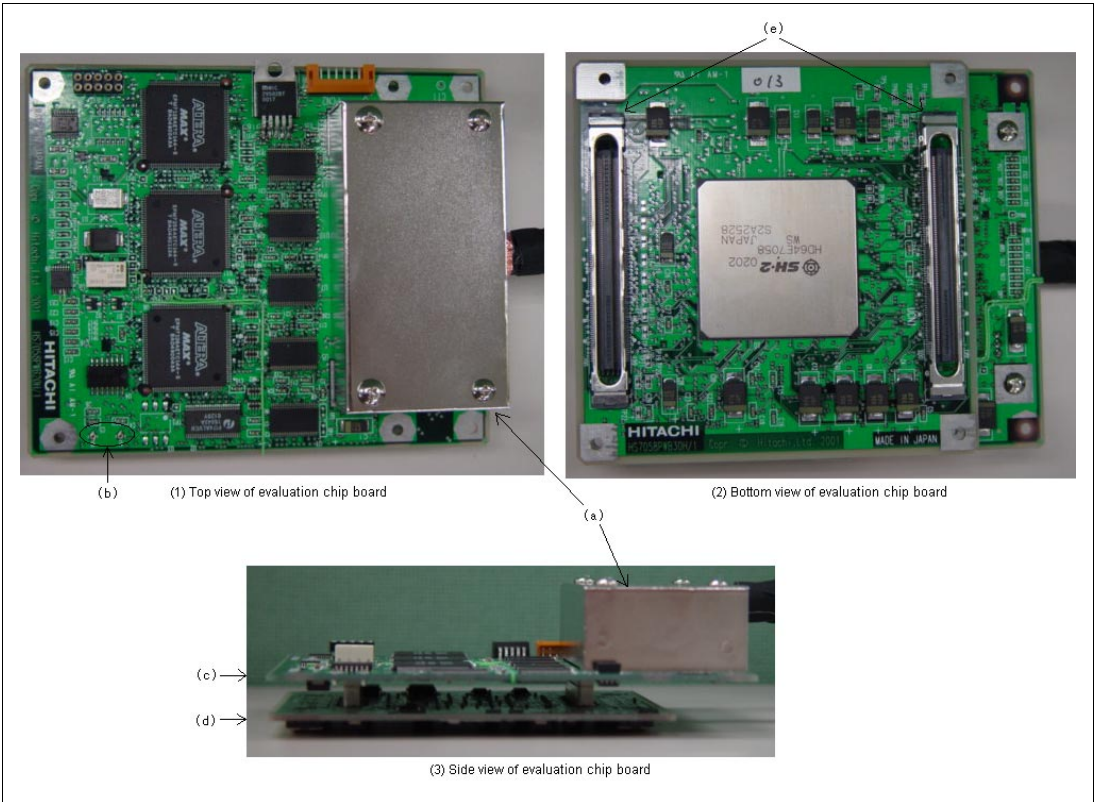

Figure 2.4 Evaluation Chip Board (HS7058EPH60H)

(a) Station to evaluation chip board interface connector cover:

This is a cover for protecting the connector that connects the E6000H station to the evaluation chip board.

(b) Crystal oscillator terminals:

For installing a crystal oscillator to be used as an external clock source for the MCU.

(c) HS7058PWB20H board:

Connector to the trace cable is attached.

(d) HS7058PWB30H board:

An evaluation chip is installed and a dedicated connector to the user system interface board or user system is attached.

(e) User system interface board
connector:

For connecting the user system interface board or
user system.

Note: (a) to (e) listed above are referred to as evaluation chip board.

2.1.3 Configuration of User System Interface Board

The names of the components of the user system interface board are given below.

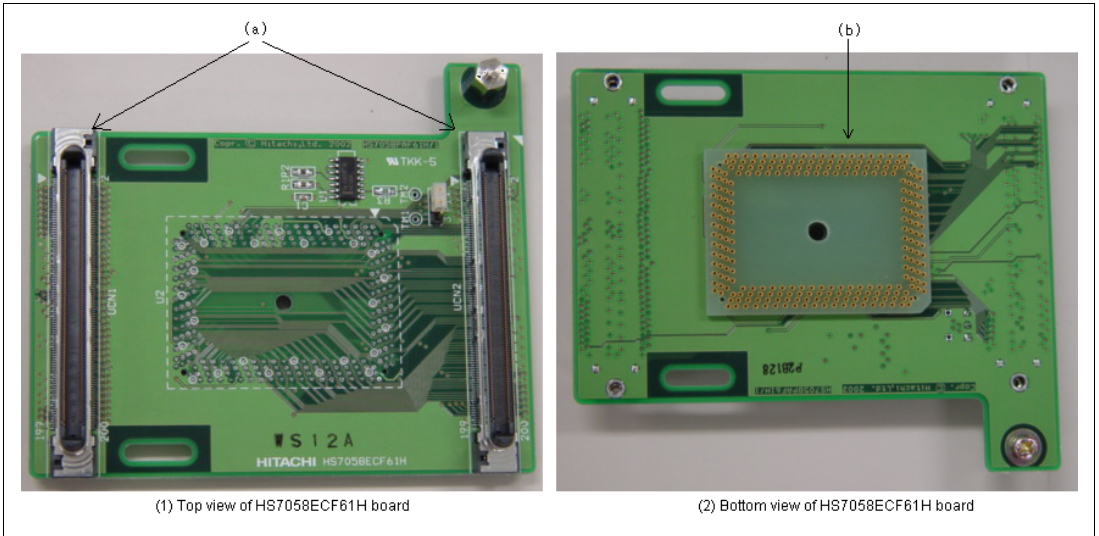

Figure 2.5 Configuration of User System Interface Board

- (a) Connector for the evaluation chip board For connection to the evaluation chip board
- (b) Connector for the user system For connection to the user system.

2.2 Configuration of the Provided CD-R

The provided CD-R contains software for the SH7058 E6000H emulator and user's manuals. Table 2.1 shows the configuration of the CD-R. All directories listed in this table are under the directory 7058 in the root directory.

Table 2.1 Contents of CD-R

Directory Name	File Name	Contents	Note
	setup.exe	Installer	
	Hdi.exe ^[*1]	HDI program for the SH7058 E6000H emulator	
\Diag	Tm7058.exe ^[*1]	Diagnostic and maintenance program	
\Drivers\Pci\95	pcihei.inf	Setup information (PCI)	For Windows [®] 98 and Windows [®] Me
\Drivers\Pci\95	pcihei.vxd	Virtual driver (PCI)	For Windows [®] 98 and Windows [®] Me
\Drivers\Pci\Nt	pcihei.sys	System file (PCI)	For Windows NT [®]
\Drivers\Pci\2000	pcihei2k.sys	System file (PCI)	For Windows [®] 2000
\Drivers\Pci\2000	pcihei2k.inf	Setup information (PCI)	For Windows [®] 2000
\Drivers\Pcmcia\95	ulepcc.inf	Setup information (PCMCIA)	For Windows [®] 98
\Drivers\Pcmcia\95	ulepcc.vxd	Virtual driver (PCMCIA)	For Windows [®] 98
\Drivers\Pcmcia\Nt	ulepccnt.sys	System file (PCMCIA)	For Windows NT [®]
\Drivers\Pcmcia\2000	ulepcc2k.sys	System file (PCMCIA)	For Windows [®] 2000
\Drivers\Pcmcia\2000	ulepcc2k.inf	Setup information (PCMCIA)	For Windows [®] 2000
\Manuals\Japanese	HS6400DIIW5SJ.pdf ^[*2]	Hitachi Debugging Interface user's manual	PDF documents in Japanese ^[*4]
\Manuals\Japanese	HS7058EPH60HJ.pdf ^[*2]	SH7058 E6000H emulator user's manual	PDF documents in Japanese ^[*4]

Table 2.1 Contents of CD-R (cont)

Directory Name	File Name	Contents	Notes
\Manuals\English	HS6400DIIW5SE.pdf [*3]	Hitachi Debugging Interface user's manual	PDF documents in English [*4]
\Manuals\English	HS7058EPH60HE.pdf [*3]	SH7058 E6000H emulator user's manual	PDF documents in English [*4]
\Pdf_read\Japanese	Ar50jpn.exe	Acrobat® Reader 5.0 installer	Japanese version
\Pdf_read\English	Ar50eng.exe	Acrobat® Reader 5.0 installer	English version
\Tutorial		Sample program	

- Notes: 1. Installed on your host computer by the installer.
2. This is the Japanese version of the manual. It cannot be installed by the English-language version of the installer.
3. This is the English version of the manual. It cannot be installed by the Japanese-language version of the installer.
4. Use the Acrobat® Reader to see PDF documents.

2.3 System Configuration

The emulator must be connected to a host computer (via the selected PC interface board).

2.3.1 System Configuration Using a PC Interface Board

The emulator can be connected to a host computer via a PC interface board (options: PCI bus or PC card bus). Install the PC interface board to the expansion slot for the interface board in the host computer, and connect the interface cable supplied with the PC interface board to the emulator. A LAN adapter can be used to connect the emulator to a host computer as a network. A USB adapter can be used to connect the emulator to a host computer with the USB interface. For details on PC interface boards (available for PCI bus and PC card bus specifications), LAN adapter, and USB adapter, refer to their description notes. Figure 2.6 shows the configuration of a system in which the PC interface board is used. Figure 2.7 shows the configuration of a system in which the LAN adapter is used. Figure 2.8 shows the configuration of a system in which the USB adapter is used.

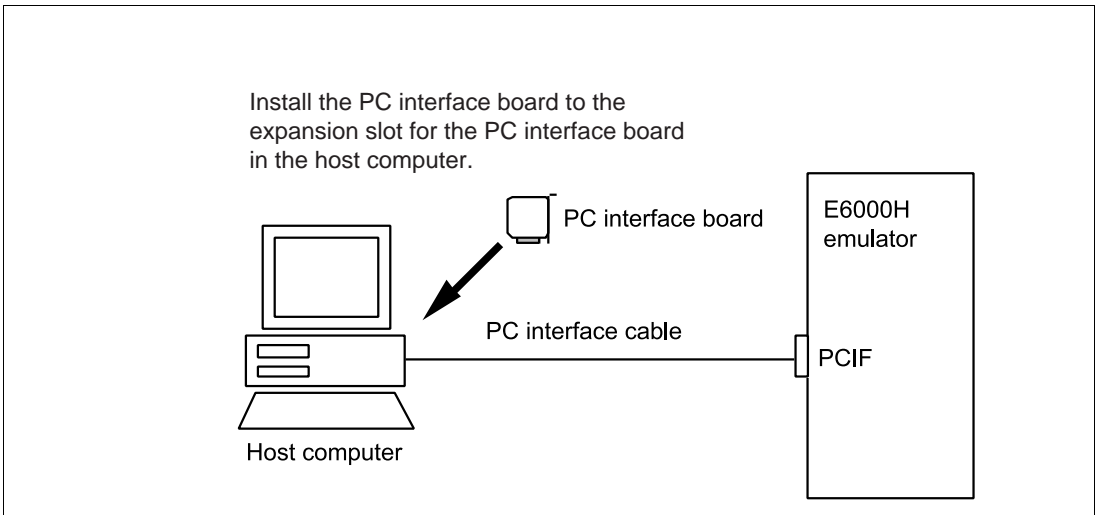

Figure 2.6 System Configuration Using a PC Interface Board

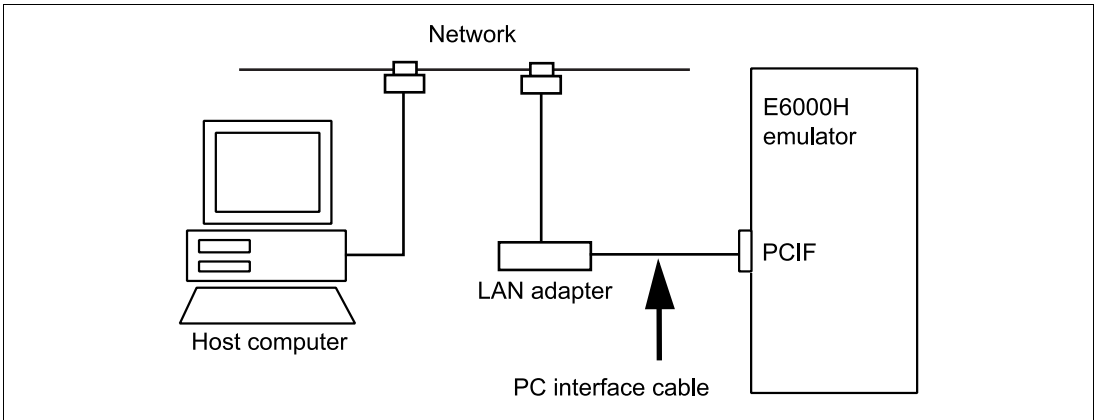

Figure 2.7 System Configuration Using a LAN Adapter

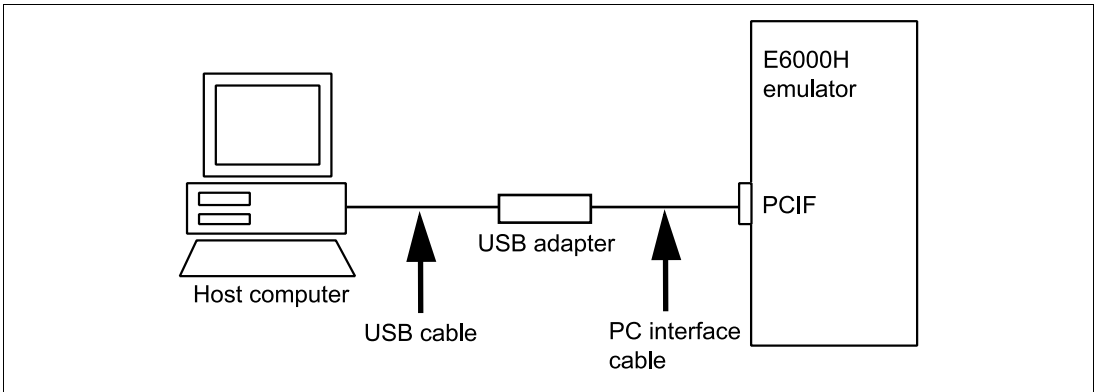

Figure 2.8 System Configuration Using a USB Adapter

Section 3 Preparation before Use

3.1 Description on Emulator Usage

This section describes the preparation before emulator usage. Figure 3.1 is a flowchart on preparation before the usage of the emulator.

CAUTION

Read this section and understand its contents before preparation. Incorrect operation will damage the user system and the emulator. The USER PROGRAM will be LOST.

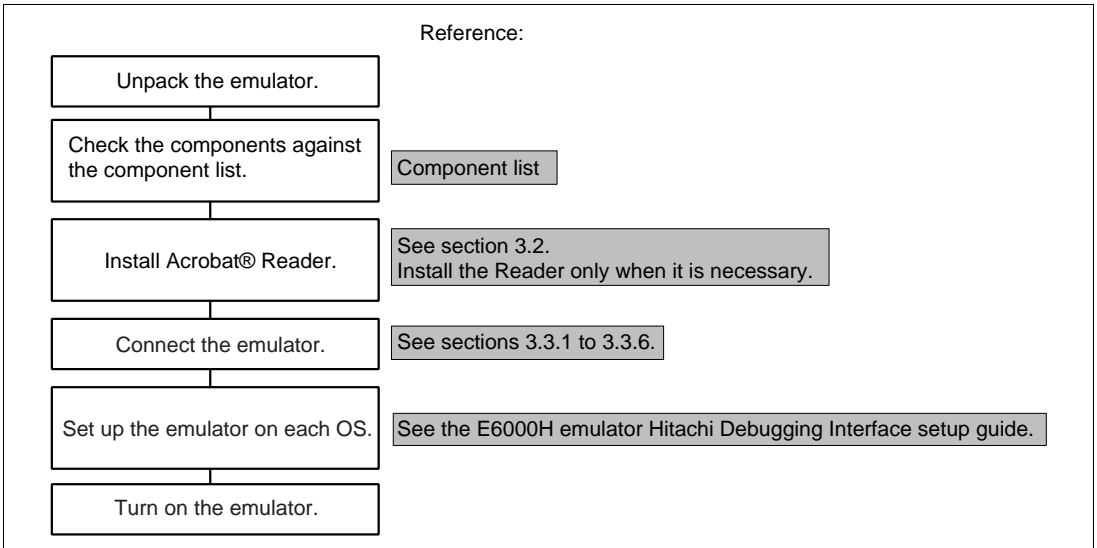

Figure 3.1 Emulator Preparation Flowchart

3.2 Installing the Acrobat® Reader

Acrobat® Reader 5.0 is required to view the online help. Acrobat® Reader is provided on the CD-R of this product. The installation of Acrobat® Reader is described below. If you have already installed Acrobat® Reader, do not carry out this procedure.

1. Insert the CD-R of this product in the CD-ROM drive.
2. Click [Run...] from the [Start] menu.
3. Specify Ar50eng.exe in Pdf_Read\English directory in the [Run] dialog box (e.g. D:\7058\Pdf_Read\English\Ar50eng.exe) then click the [OK] button.
4. Install according to the instructions displayed in the screen.

3.3 Emulator Connection

The following description is given on emulator connection.

3.3.1 Connecting the User System



Always switch OFF the emulator and user system before connecting or disconnecting any CABLES. Failure to do so will result in a FIRE HAZARD and will damage the user system and the emulator or will result in PERSONAL INJURY. The USER PROGRAM will be LOST.

1. Check that the emulator power switch is turned off. Ensure that the power lamp on the right side of the E6000H station's front panel is not lit.
2. Remove the AC power cable of the E6000H station from the outlet (if the cable is connected to the outlet).
3. Connect pin 1 on the user system connector to the connector installed at the bottom of the E6000H user system interface board. When connecting the connector, prevent the upper or lower side of the board from lifting off the connector. Alternately tighten the screws on both sides of the board.

3.3.2 Connecting the User System Interface Board

! WARNING

Always switch OFF the emulator and user system and check pin numbers on the connectors and IC socket before connecting or disconnecting the USER SYSTEM INTERFACE BOARD. Connection with the power on or incorrect connection will damage the emulator, user system interface board, and user system, and result in a FIRE HAZARD.

For details on the method of connecting the user system interface board, refer to the descriptions of the user system interface boards for individual SH7058 E6000H-series products.

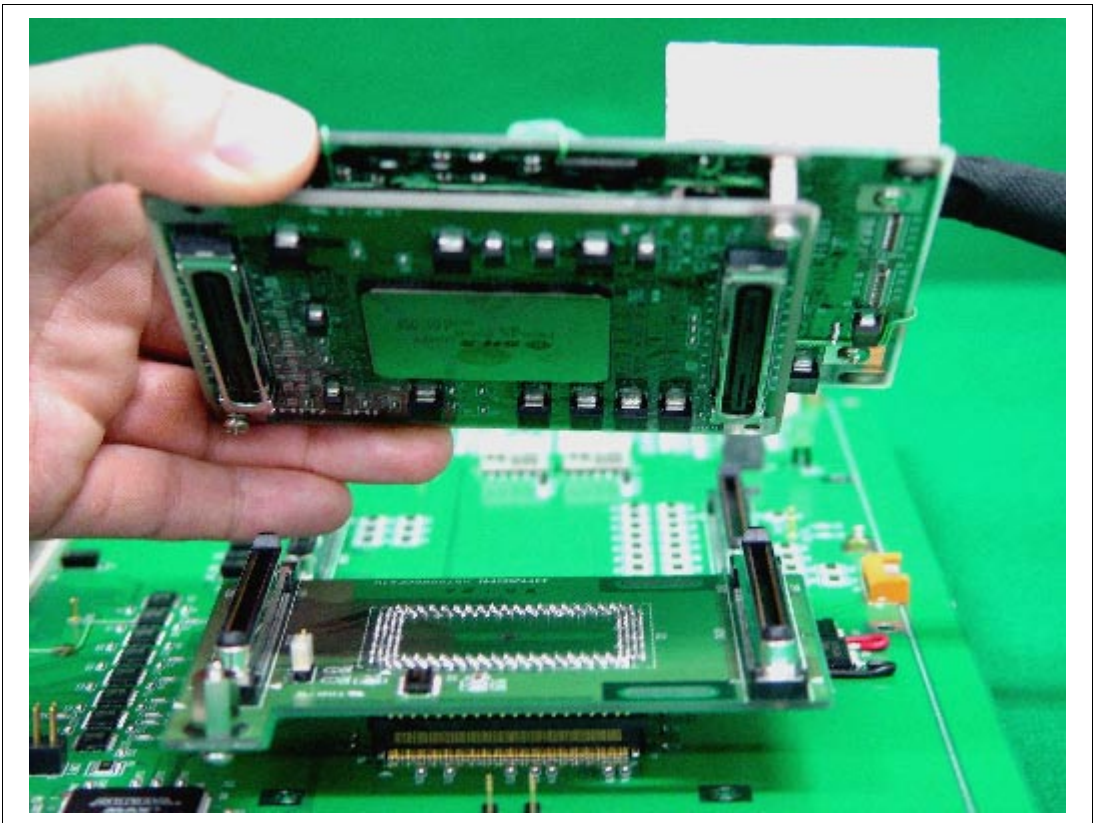
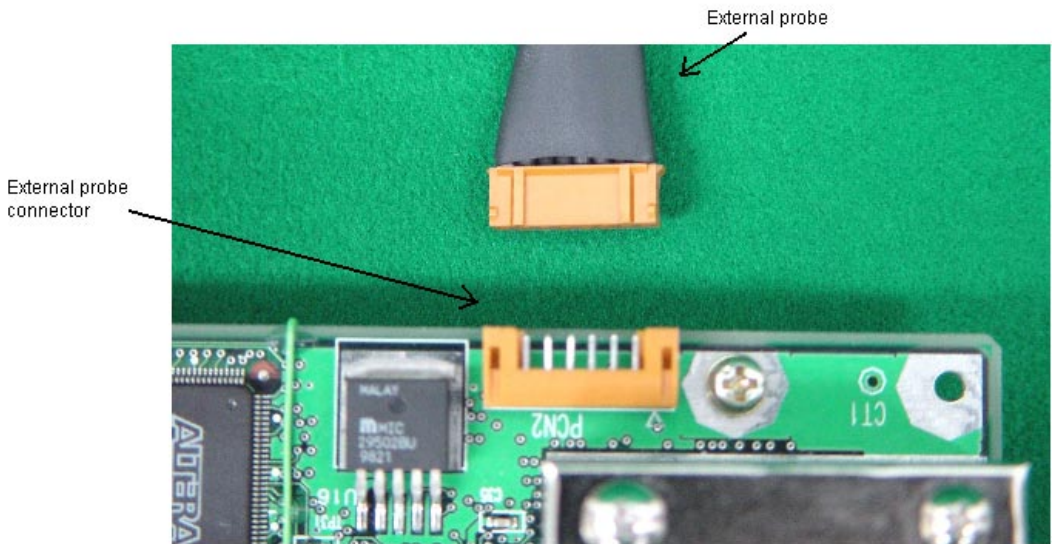

Figure 3.2 Connecting the User System Interface Board

CAUTION

Check the external probe direction and connect the external probe to the emulator station correctly. Incorrect connection will damage the probe or connector.

When an external probe is connected to the emulator probe connector on the E6000H evaluation chip board's rear panel, it enables external signal tracing and multibreak detection. Figure 3.3 shows the external probe connector.



Pin No.	Probe Name	Signal Name	Note
1	1	Probe input 0	Synchronous break
2	2	Probe input 1	input pin
3	3	Probe input 2	
4	4	Probe input 3	
5	5	GND	GND connection pin
6	6	Trigger output	Trigger mode output pin
7	7	GND	GND connection pin
8	8	RUN or break output	Low-level output at RUNSTEP output

Figure 3.3 External Probe Connector

3.3.4 Selecting the Clock

This emulator supports three types of clock for the MCU: a crystal oscillator attached on the evaluation chip board, external clock input from the user system, and the emulator internal clock. The clock is specified with the [Configuration] dialog box or the CLOCK command.

This emulator can use a clock source (ϕ) running at up to 80.0 MHz (eight times the external clock frequency of 10.0 MHz) as the MCU clock input.

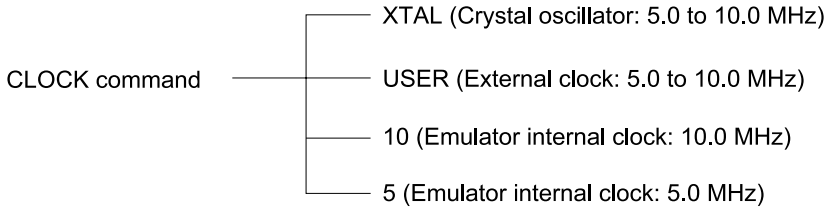

Crystal Oscillator: A crystal oscillator is not supplied with the emulator. Prepare and use one that has the same frequency as that of the user system. When using a crystal oscillator as the MCU clock source, the frequency range must be from 5.0 to 10.0 MHz.

CAUTION

Always switch OFF the emulator and user system before connecting or disconnecting the CRYSTAL OSCILLATOR. Otherwise, the USER PROGRAM will be LOST.

Use the following procedure to install the crystal oscillator:

1. Check that the emulator power switch is turned off. (Check that the power LED is not lit.)
2. Attach the crystal oscillator into the terminals on the evaluation chip board (figure 3.4).
3. Turn on the user system power and then the emulator power. Then crystal oscillator will be automatically set and setup. This function will allow the execution of the user program at the operating frequency of the user system even when the user system is not connected to the emulator.

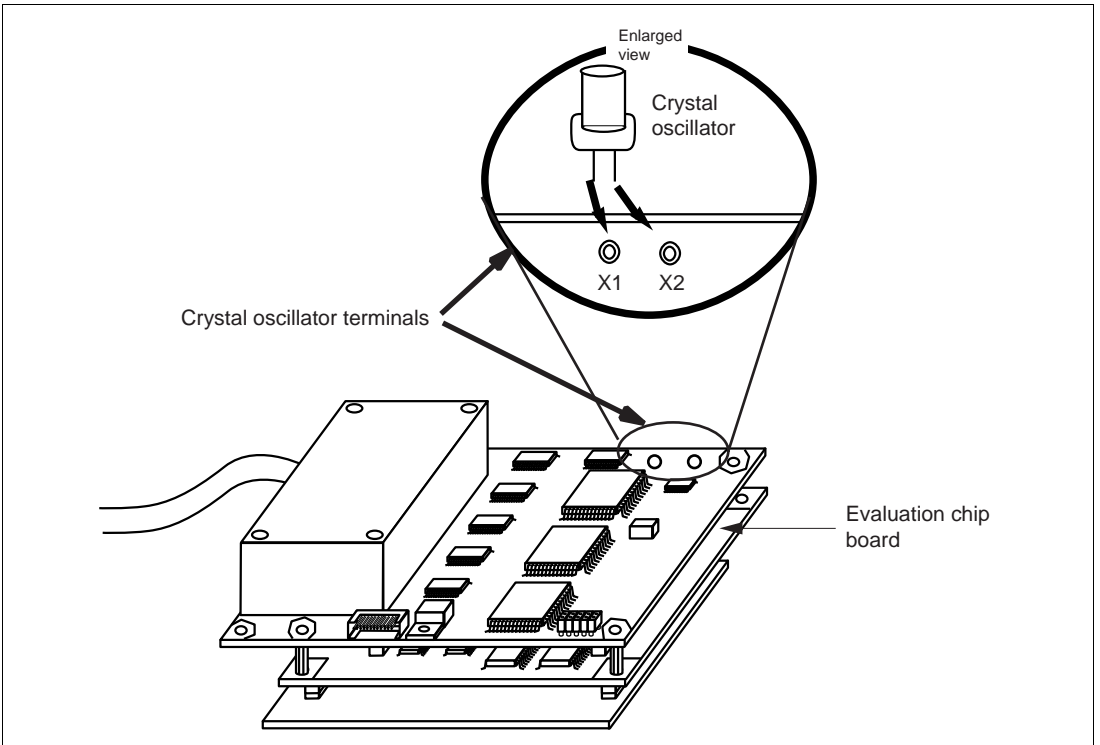

Figure 3.4 Installing the Crystal Oscillator

External Clock: Use the following procedure to select the external clock.

1. Check that the emulator power switch is turned off. (Check that the power LED is not lit.)
2. Connect the evaluation chip board to the user system and supply a clock through the EXTAL pin from the user system.
3. Turn on the user system power and then the emulator power. USER (the external clock) will then be automatically specified by a CLOCK command.

Emulator Internal Clock: Specify 5 (5.0 MHz) or 10 (10.0 MHz) in the [Configuration] dialog box or with the CLOCK command.

Reference:

When the emulator system program is initiated, the emulator automatically selects the MCU clock source according to the following priority:

1. User system's clock when an external clock is supplied from the user system
2. Crystal oscillator when attached to the evaluation chip board
3. Emulator internal clock

CAUTION

Separate the frame ground from the signal ground at the user system. When the frame ground is connected to the signal ground and the emulator is then connected to the user system, the emulator will malfunction.

The emulator's signal ground is connected to the user system's signal ground via the evaluation chip board. In the E6000H station, the signal ground and frame ground are connected (figure 3.5). At the user system, connect the frame ground only; do not connect the signal ground to the frame ground.

If it is difficult to separate the frame ground from the signal ground in the user system, ground the frame to the same outlet as the 100-V to 240-V power supply of the emulator station (figure 3.6) so that the ground potentials become even.

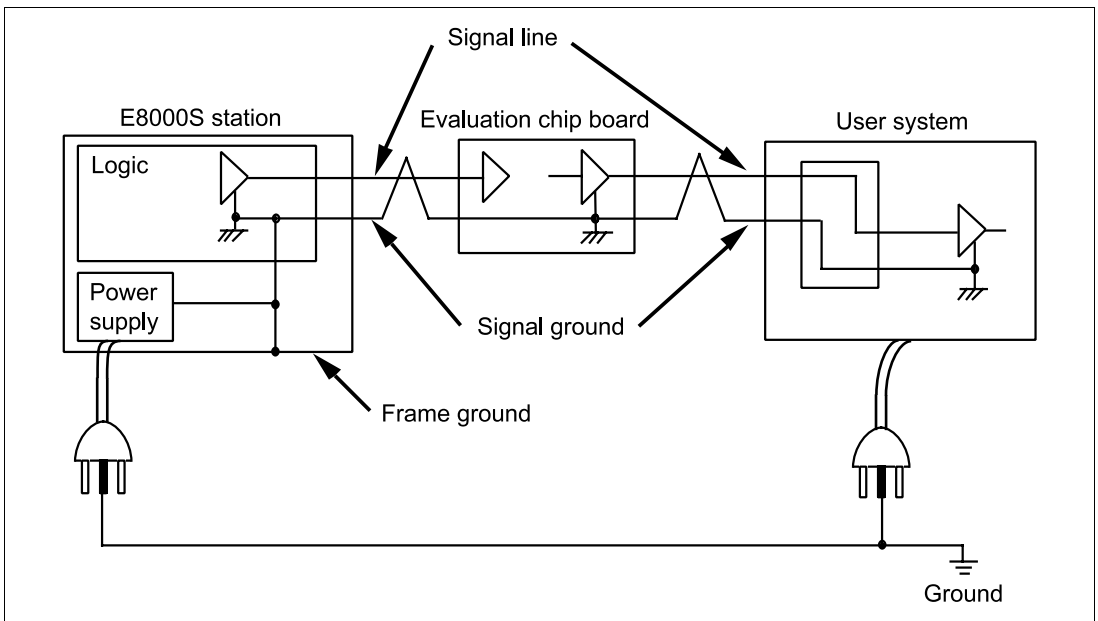

Figure 3.5 Connecting the System Ground

WARNING

Always switch OFF the emulator and user system before connecting or disconnecting any CABLES. Failure to do so will result in a FIRE HAZARD and will damage the user system and the emulator or will result in PERSONAL INJURY. The USER PROGRAM will be LOST.

The user system must be connected to an appropriate ground so as to minimize noise and the adverse effects of ground loops. When connecting the evaluation chip board and the user system, confirm that the ground pins of the evaluation chip board are firmly connected to the user system's ground.

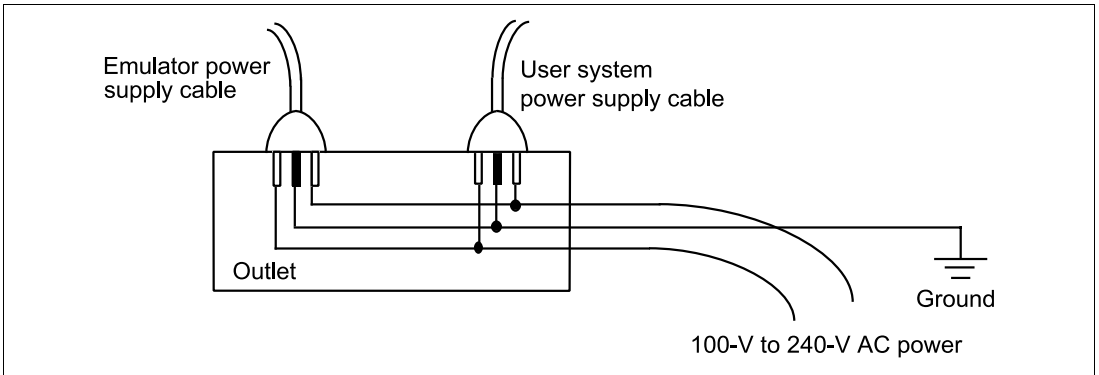

Figure 3.6 Connecting the Frame Ground

3.3.6 PC Interface Board Specifications (PCI Bus Specifications)

PC Interface Board Specifications: Table 3.1 lists the PCI-bus PC interface board specifications. For details on other interface boards, refer to their description notes.

Table 3.1 PC Interface Board Specifications

Item	Specifications
Host computer that can be used	PC with a PCI slot, or compatible machine
OS	Microsoft® Windows NT® 4.0, Windows® 98, Windows® Me, or Windows® 2000 operating system
Memory area	16 kbytes
PCI-bus specifications	Conforms to revision 2.1

Installing the PC Interface Board:

WARNING

Always switch OFF the host computer and peripheral devices connected to the host computer before installing the PC interface board. Failure to do so will result in a FIRE HAZARD and will damage the host computer, interface board, and peripheral devices, or will result in PERSONAL INJURY.

Remove the cover of the host computer and install the PC interface board in the PCI-bus specification extension slot. Tighten the screw after confirming that the PC interface cable can be connected to the board.

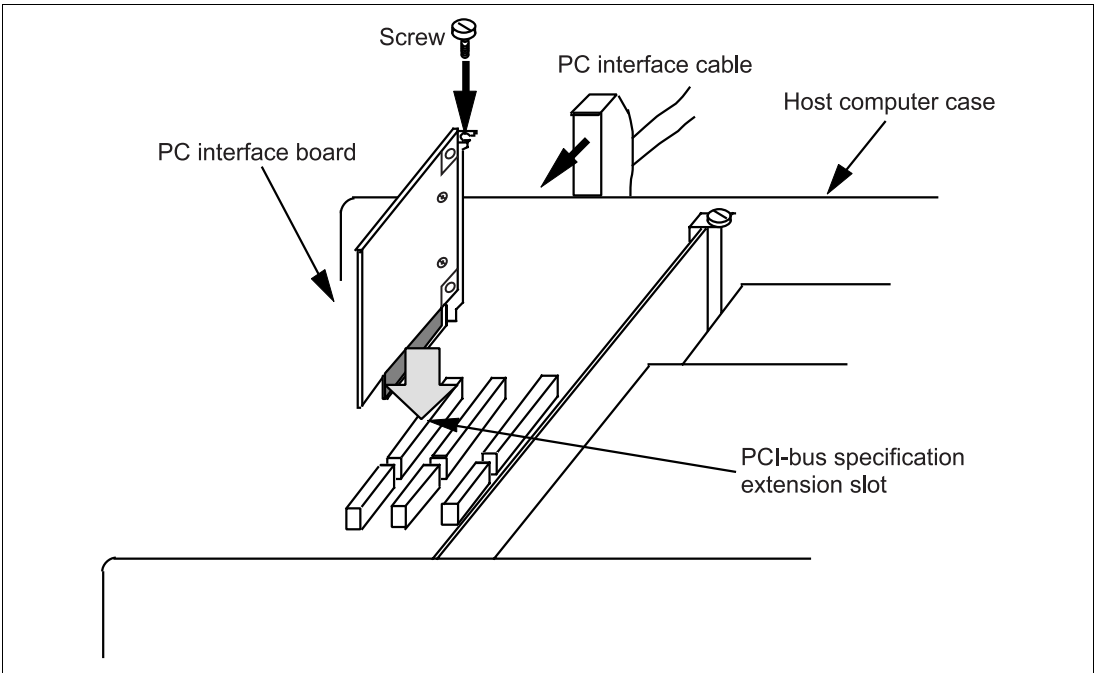

Figure 3.7 Installing the PCI Interface Board

Connecting the E6000H Station to the PC Interface Board:

! WARNING

Always switch OFF the emulator and user system before connecting or disconnecting any CABLES. Failure to do so will result in a FIRE HAZARD and will damage the user system and the emulator, or will result in PERSONAL INJURY. The USER PROGRAM will be LOST.

Before using the emulator, connect the E6000H station to the PC interface board with the PC interface cable supplied, as shown in figure 3.8.

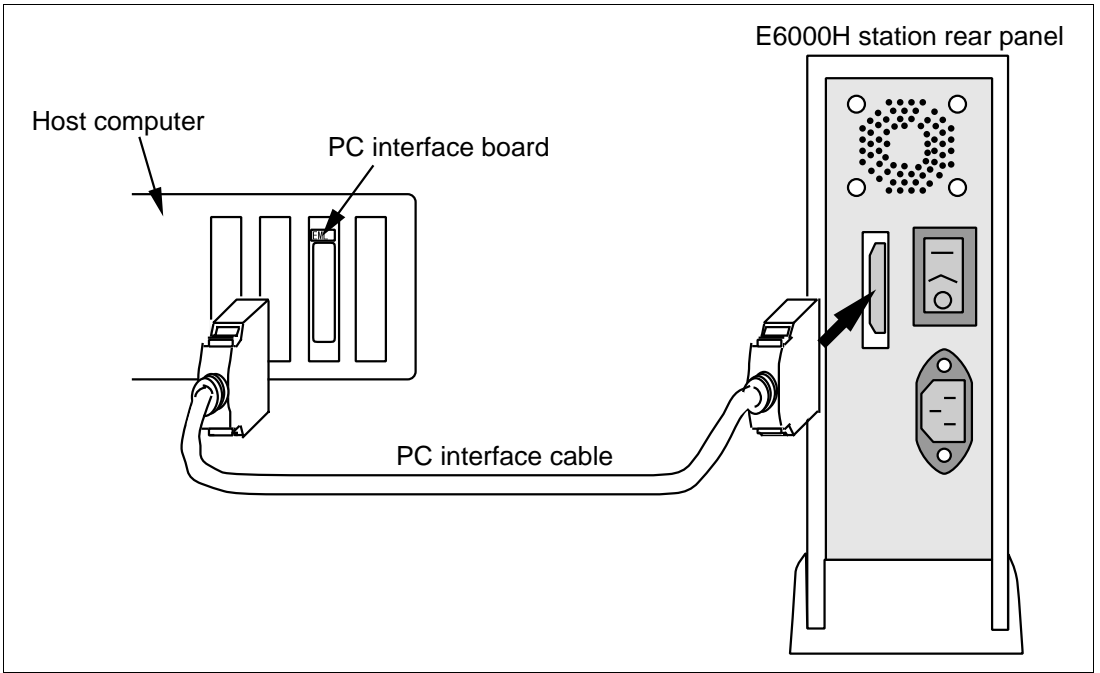

Figure 3.8 Connecting the E6000H Station to the PC Interface Board

Section 4 Tutorial

4.1 Introduction

The following describes the main functions of the HDI by using a sample program for sorting random data. For more complicated usage, refer to section 5, Emulator Functions. This tutorial assumes that the user system is not connected.

The sample program performs the following actions:

- The `main` function generates 10 pieces of random data to be sorted.
- The `sort` function generates the array and inputs the random data in the array, and sorts the random data in ascending order.
- The `change` function inputs the array generated by the `sort` function, and changes the data in descending order.

Note: This sample program is created by using the SuperH RISC engine C/C++ compiler Package (V6.0A).

4.2 Running the HDI

- To run the HDI, select the [SH7058 E6000H Emulator Software]-[Hitachi Debugging Interface] from the [Start] menu.

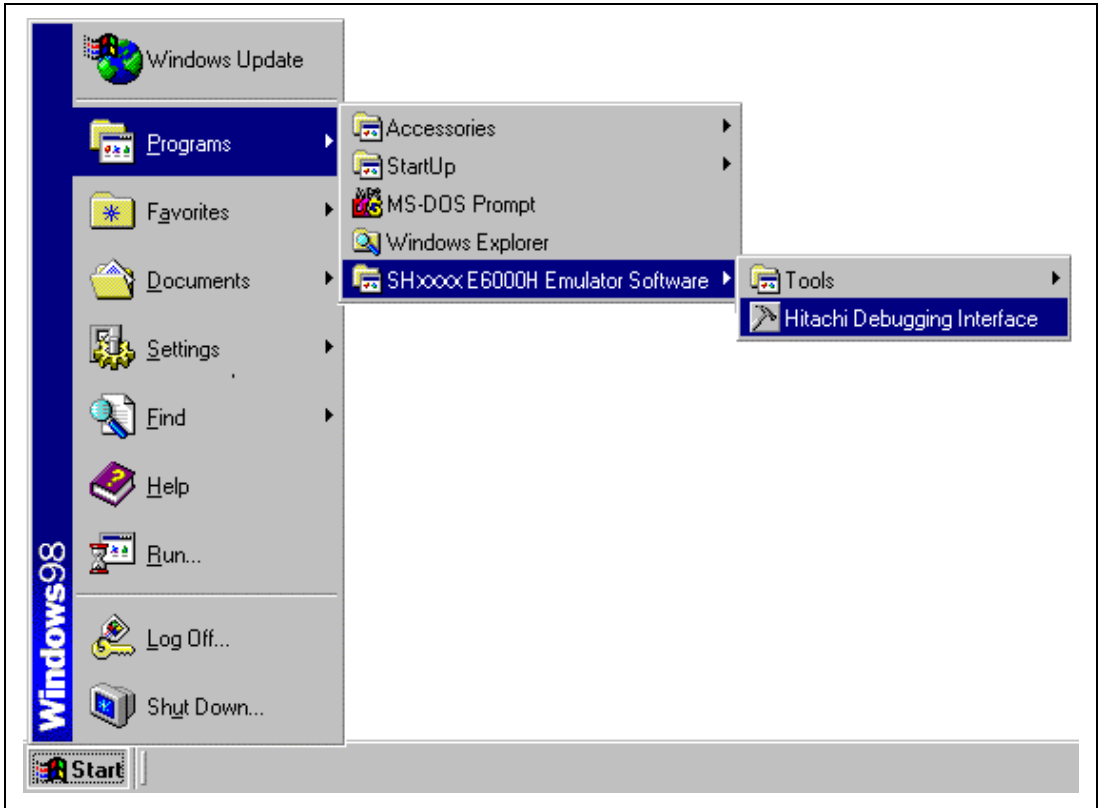

Figure 4.1 [Start] Menu

The HDI window as shown in figure 4.2 is displayed. Here the [Select Session] dialog box is displayed. Select the target MCU name of the installed HDI and click the [OK] button.

The settings related to the MCU, such as the MCU operating mode, can be performed on the [General] page in the [Configuration] dialog box. Table 4.1 lists the settings when running the sample program.

**Table 4.1 [General] Page in the [Configuration] Dialog Box Setting Example:
Configuration of the [General] Page**

Option	Setting Value
[Device]	SH7058
[Mode]	3 (On-chip ROM or Single Chip)
[Clock]	5 MHz
[H-UDI (JTAG) Clock]	10 MHz
[Timer Resolution]	20 ns
[Input Frequency]	Input prohibited
[Flash Load Option]	Disabled
[User Signals]	All enabled
[Bus timeout]	100 us
[Enable interrupts during step execution]	Disabled
[Enable select AUD to Emulator]	Enabled
[Enable multi break]	Disabled
[User VCC Threshold]	4.4 V

The settings can be checked on the [General] page in the [Configuration] dialog box.

For details on the [General] page in the [Configuration] dialog box, refer to section 5.2, Setting the Emulator's Operating Conditions.

The HDI window is shown in figure 4.2.

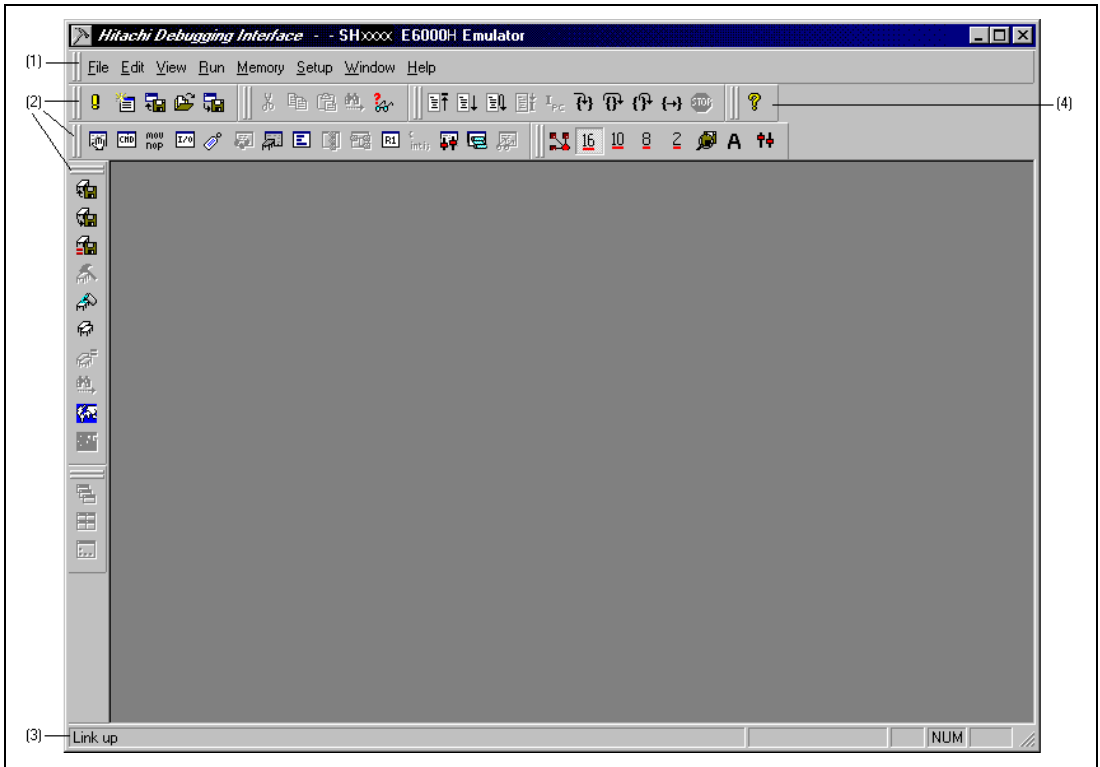

Figure 4.2 HDI Window

Numbers in figure 4.2 indicate the following:

1. Menu bar
Indicates the HDI command menus for the use of the HDI.
2. Toolbar
Contains convenient buttons as shortcuts of menu commands.
3. Status bar
Indicates the state of the emulator and progress information about downloading.
4. [Help] button
Activates the HDI on-line help.

4.3 Setting the Memory Map

In the next step, allocate the emulation memory.

- Select [Configure platform...] from the [Setup] menu to display the current memory map.

The [Configuration] dialog box is displayed. Click the [ERam] tab to display the [ERam] page.

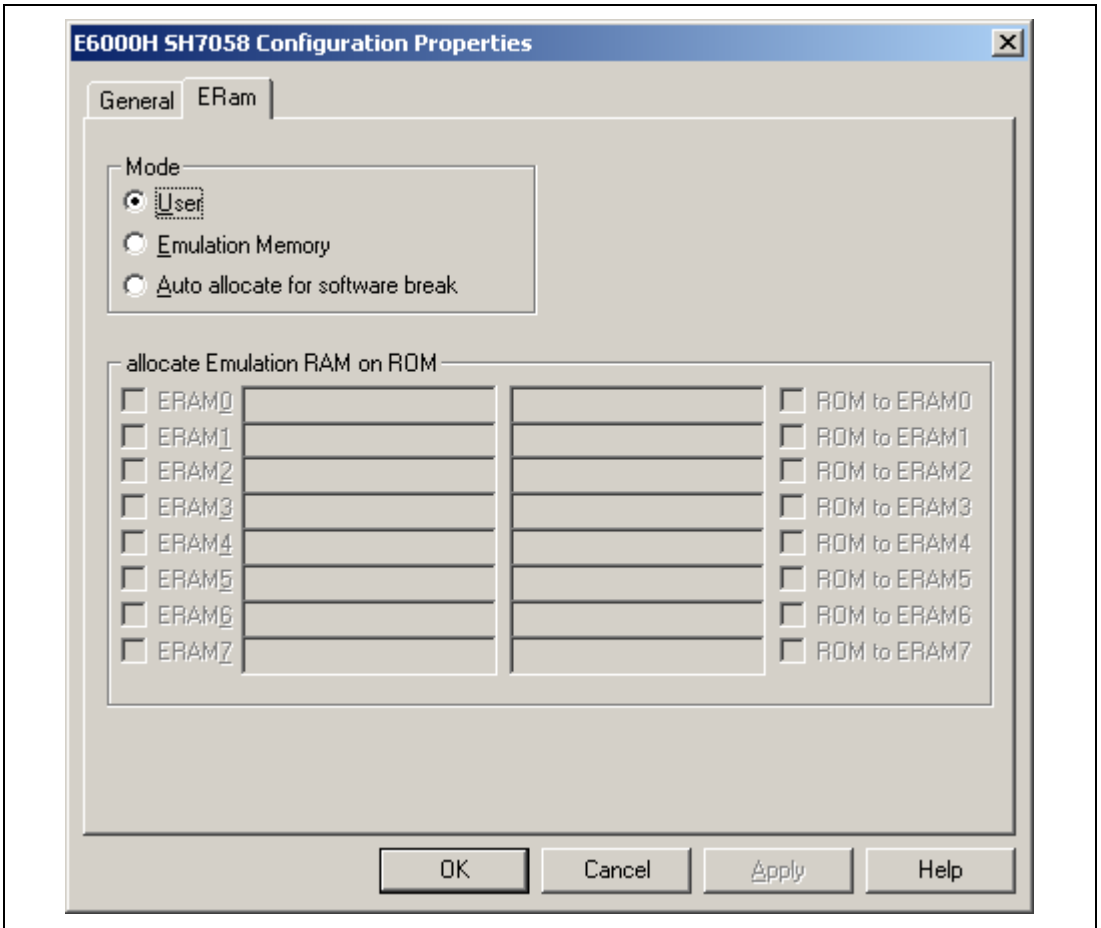

Figure 4.3 [ERam] Page (before Setting)

The emulator can allocate emulation memory to eight ROM areas in 4-kbyte units.

When [Emulation Memory] in the [Mode] group box is selected, the [allocate Emulation RAM on ROM] group box is enabled. In the tutorial program, allocate H'00000000 to H'0000FFF and H'00001000 to H'00001FFF as the emulation memory area.

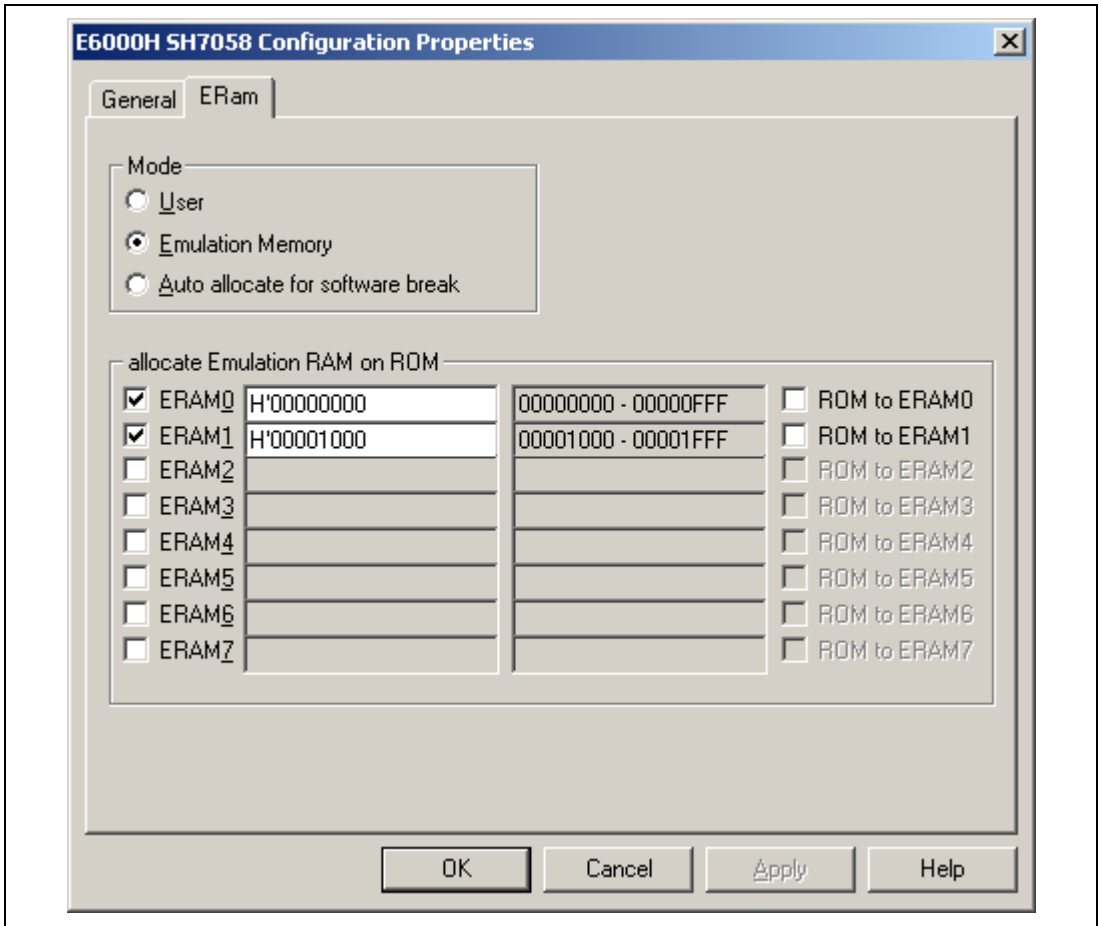

Figure 4.4 Allocating the Emulation Memory

- Check the [ERAM0] check box and enter H'00000000 in the address box. Similarly, check the [ERAM1] check box and enter H'00001000 in the address box. The value in the gray address box shows the range that the memory has been allocated.
- Click the [OK] button after values have been entered.

For details on the allocation of emulation memory, refer to the [ERam] Page in section 5.2.1.

4.4 Downloading

4.4.1 Downloading the Sample Program

Download the sample program in the ELF/DWARF2 format to be debugged.

- Select [Load Program...] from the [File] menu. The [Load Program] dialog box is displayed.
- Click the [Browse...] button. The [Open] dialog box will be displayed.
- Select the file TUTORIAL.ABS, and click the [Open] button.

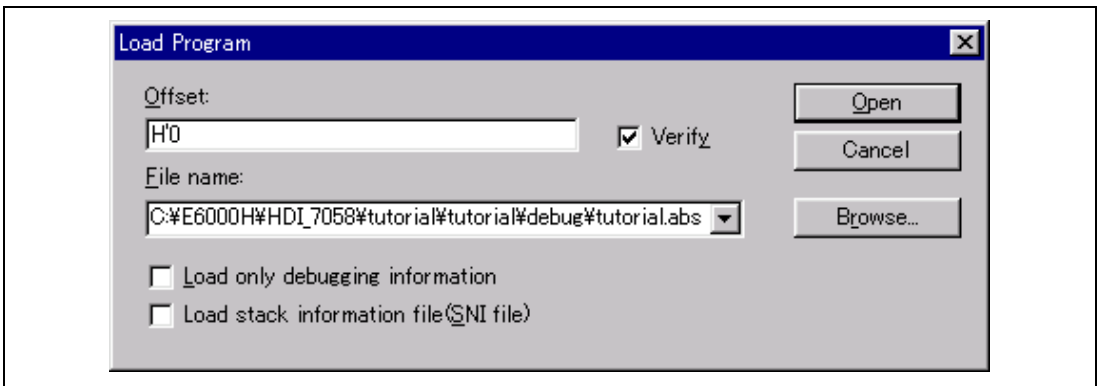

Figure 4.5 [Load Program] Dialog Box

- Click the [Open] button in the [Load Program] dialog box.

The following dialog box will be displayed when the program completes loading. In the dialog box, the address where the program was loaded is displayed.



Figure 4.6 [HDI] Dialog Box

- Click the [OK] button.

4.4.2 Displaying the Source Program

The [Source] window allows the user to display the C/C++ language source program, set breakpoints, execute the program, and select variables, so the user can debug a program at the source level.

- Select [Source...] from the [View] menu.

The [Open] dialog box is displayed.

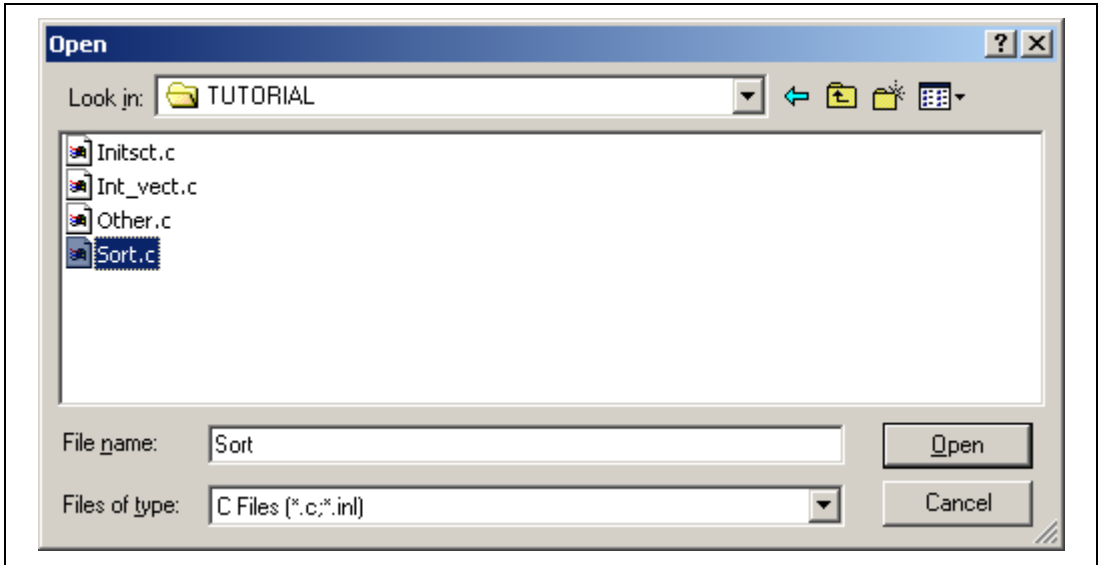
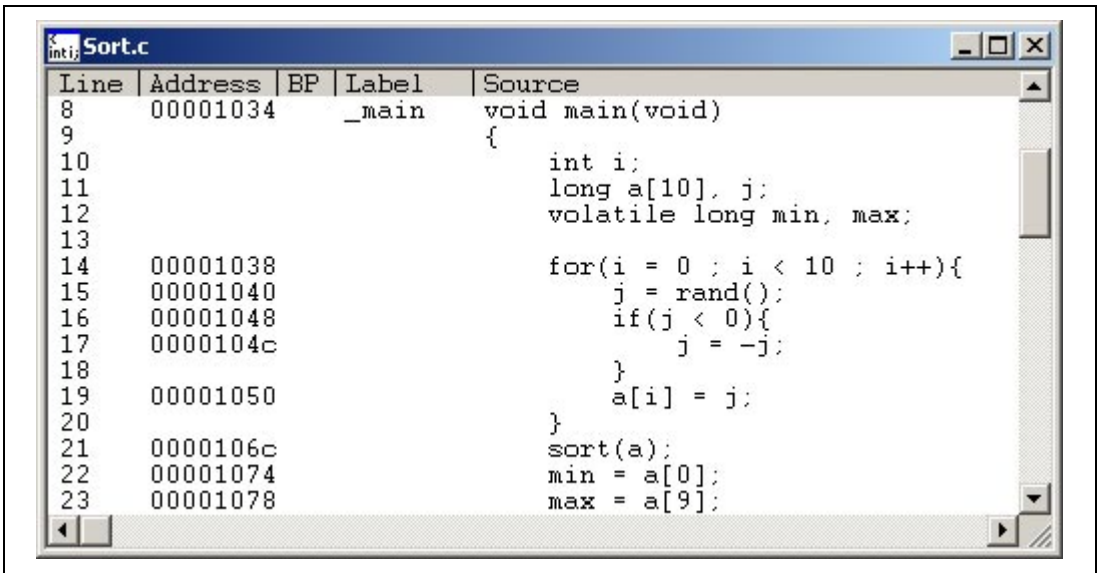

Figure 4.7 [Open] Dialog Box

- Select [Sort.c] and click the [Open] button. The [Source] window is displayed. If necessary, select whatever font or size you like, by selecting the [Font...] option from the [Customize] submenu in the [Setup] menu.



Line	Address	BP	Label	Source
8	00001034		_main	void main(void)
9				{
10				int i;
11				long a[10], j;
12				volatile long min, max;
13				
14	00001038			for(i = 0 ; i < 10 ; i++){
15	00001040			j = rand();
16	00001048			if(j < 0){
17	0000104c			j = -j;
18				}
19	00001050			a[i] = j;
20				}
21	0000106c			sort(a);
22	00001074			min = a[0];
23	00001078			max = a[9];

Figure 4.8 [Source] Window (Displaying the Source Program)

4.5 Setting the Program Counter Breakpoints

A breakpoint is one of the debugging functions.

The [Source] window provides a very simple way of setting program counter (PC) breakpoints. For example, to set a breakpoint at the line that contains the `sort` function call:

- Double-click the [BP] column on the line containing the `sort` function call.

The • will be displayed on the line containing the `sort` function to show that a software breakpoint is set at that address.

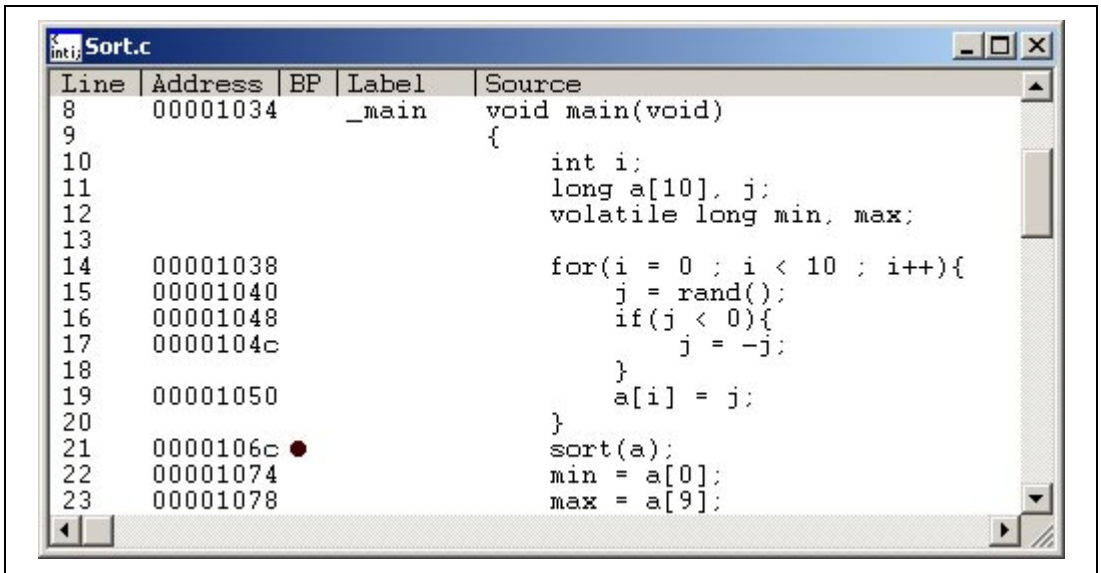

Figure 4.9 [Source] Window (Setting a PC Breakpoint)

The emulator has many break functions. For details, refer to section 5.6, Break Functions.

4.6 Executing the Program

- To execute the program, select [Reset Go] from the [Run] menu, or click the [Reset Go] button on the toolbar.

The program will be executed up to the breakpoint that has been set, and will then stop. The line where the program has halted will be highlighted in the [Source] window.

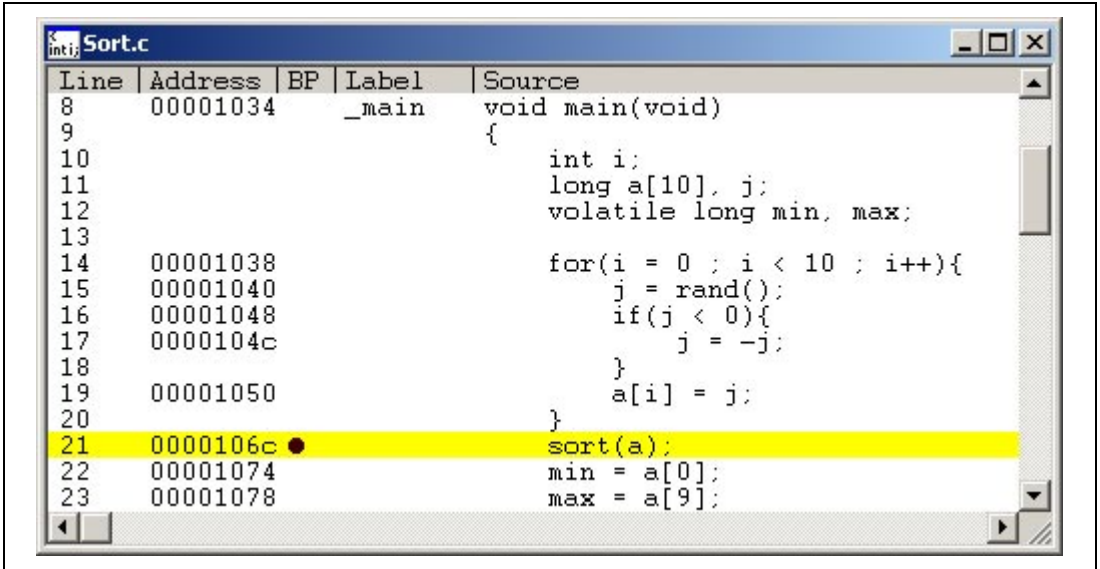

Figure 4.10 [Source] Window (Break State)

The user can see the cause of the last break through the [Platform] sheet in the [System Status] window.

- Select [Status] from the [View] menu. The [System Status] window is displayed.
- Select [Platform] sheet from the [System Status] window.

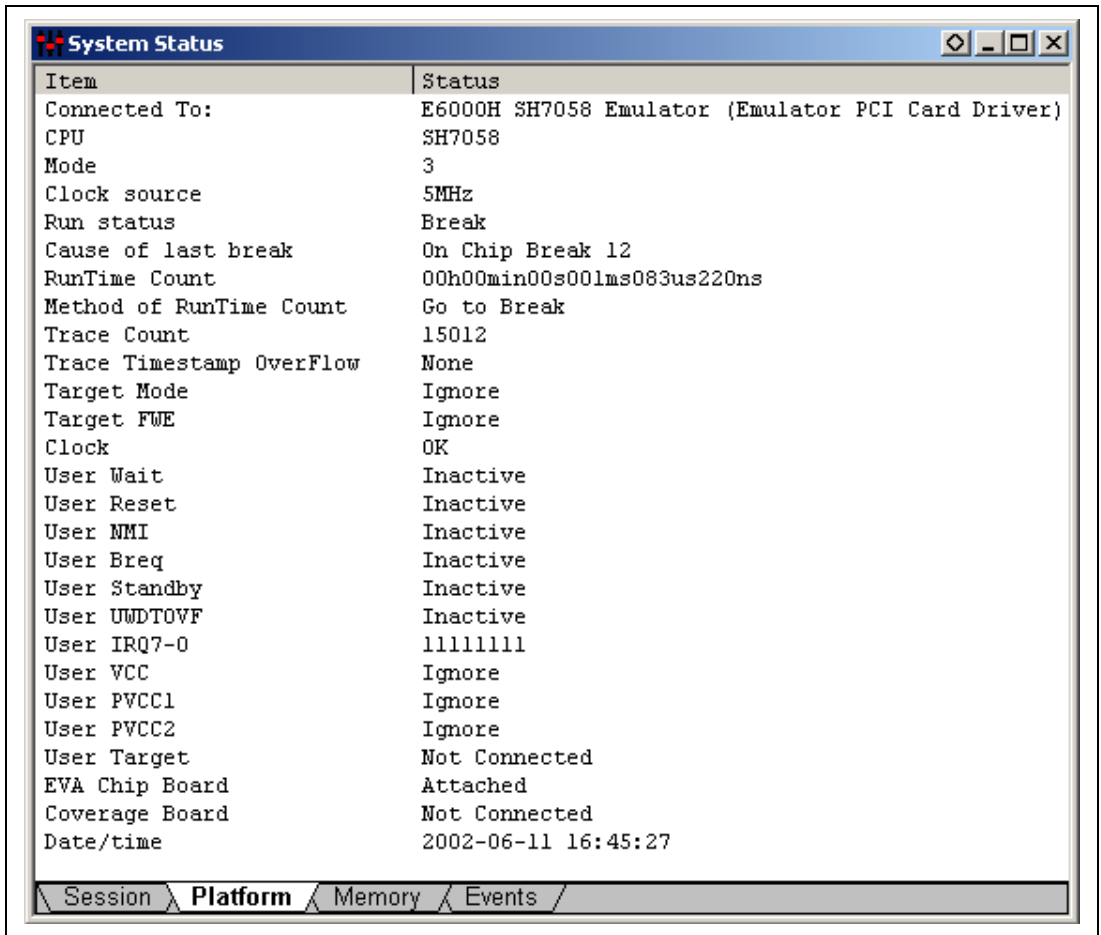

Figure 4.11 [System Status] Window

The [Cause of last break] line shows that the cause of the break is On Chip Break 12.

For details on program execution, refer to section 5.3, Program Execution.

4.7 Reviewing Breakpoints

The user can see all the breakpoints set in the program in the [Breakpoints] window.

- Select [Breakpoints] from the [View] menu. The [Breakpoints] window is displayed. The contents of the breakpoint set will be displayed. A ● will be displayed in the [Enable] column.

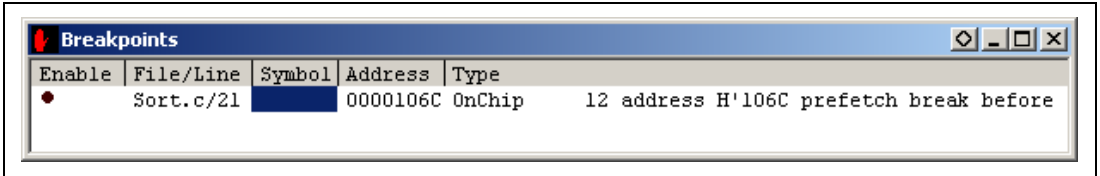

Figure 4.12 [Breakpoints] Window

The [Breakpoints] window also allows the user to change breakpoints, set new breakpoints, and delete breakpoints.

- Close the [Breakpoints] window.

4.8 Viewing Memory

The user can view the contents of a memory block in the [Memory] window. For example, to view the memory contents corresponding to the external variable array `a`:

- Select [Memory...] from the [View] menu. The [Open Memory Window] dialog box is displayed.
- Input `a` in the [Address] edit box, and set the [Format] combo box as [Long Word].

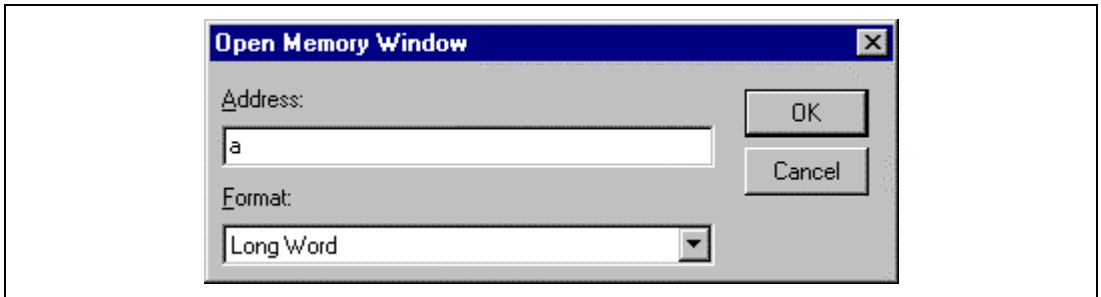
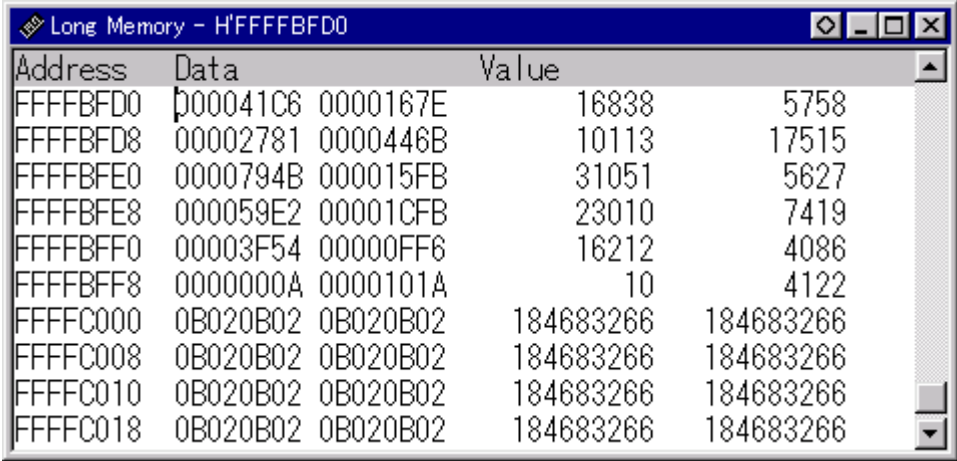

Figure 4.13 [Open Memory Window] Dialog Box

- Click the [OK] button. The [Long Memory] window showing the specified area of memory is displayed.



The screenshot shows a window titled "Long Memory - H'FFFFBFD0". The window contains a table with three columns: "Address", "Data", and "Value". The "Data" column contains pairs of hexadecimal values, and the "Value" column contains two decimal values per row. The table is as follows:

Address	Data	Value
FFFFBFD0	000041C6 0000167E	16838 5758
FFFFBFD8	00002781 0000446B	10113 17515
FFFFBFE0	0000794B 000015FB	31051 5627
FFFFBFE8	000059E2 00001CFB	23010 7419
FFFFBFF0	00003F54 00000FF6	16212 4086
FFFFBFF8	0000000A 0000101A	10 4122
FFFFC000	0B020B02 0B020B02	184683266 184683266
FFFFC008	0B020B02 0B020B02	184683266 184683266
FFFFC010	0B020B02 0B020B02	184683266 184683266
FFFFC018	0B020B02 0B020B02	184683266 184683266

Figure 4.14 [Long Memory] Window

4.9 Watching Variables

As the user steps through a program, it is possible to watch the values of variables used in the program. For example, to check the contents of the long-type array `a` declared at the beginning of the program, use the following procedure:

- Click the left of array `a` displayed in the [Source] window to position the cursor.
- Click the [Source] window with the right mouse button, and select [Instant Watch...] from a pop-up menu.

The [Instant Watch] dialog box is displayed.

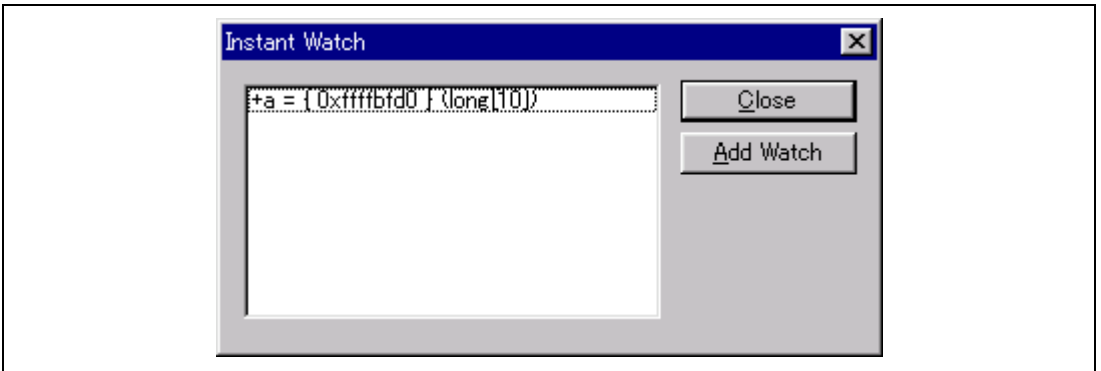

Figure 4.15 [Instant Watch] Dialog Box

- Click the [Add Watch] button to add a variable to the [Watch Window] window.

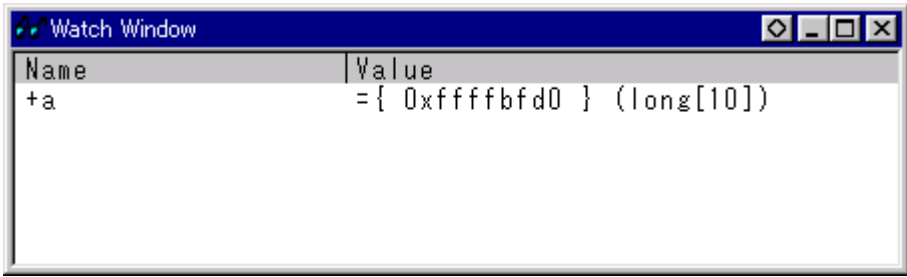

Figure 4.16 [Watch Window] Window (Displaying the Array)

The user can also add a variable to the [Watch Window] window by specifying its name.

- Click the [Watch Window] window with the right mouse button and select [Add Watch...] from the pop-up menu.

The [Add Watch] dialog box is displayed.

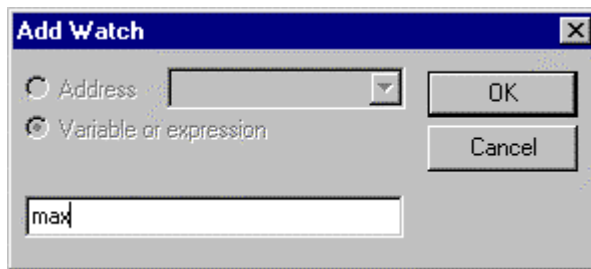

Figure 4.17 [Add Watch] Dialog Box

- Input variable **max** and click the [OK] button.

The [Watch Window] window will now also show the Volatile long-type variable max.

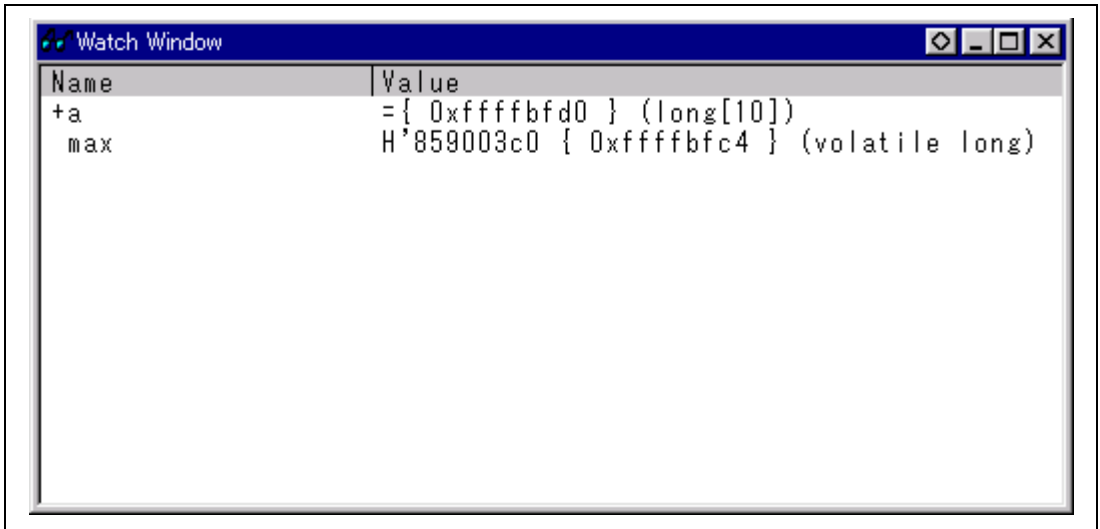

Figure 4.18 [Watch Window] Window (Displaying the Variable)

- Double-click the + symbol to the left of array a in the [Watch Window] window to expand the variable and watch all the elements in the array.

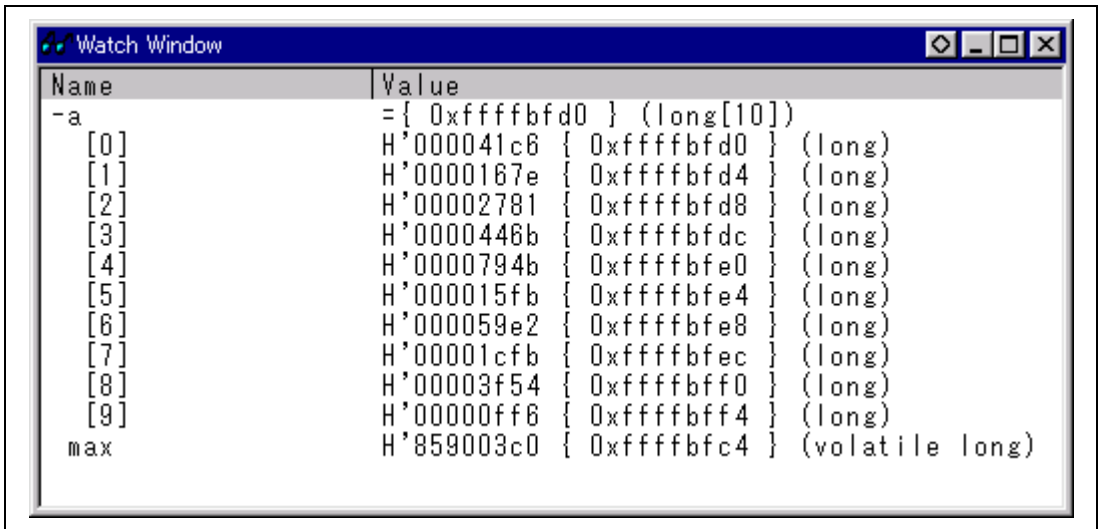

Figure 4.19 [Watch Window] Window (Displaying Array Elements)

4.10 Stepping Through a Program

The HDI provides various step commands that allow efficient program debugging. For details on step function, refer to section 5.5, Step Functions.

Table 4.2 Step Command

Command	Description
Step In	Steps through the statements in a function by each line, or steps through assembly statements by each instruction. (For a line that calls a function, execution stops at the first line of the called function.)
Step Over	Steps through the statements in a function by each line, or steps through assembly statements by each instruction. (For a line that calls a function, the whole of the called function is executed in a single step.)
Step Out	Steps out of a function, and stops at the next line that calls the function in the program.
Step...	Steps the specified counts repeatedly at a specified rate.

Before executing program stepping, confirm that the program is executed up to the sort function line at address H'0000106c.

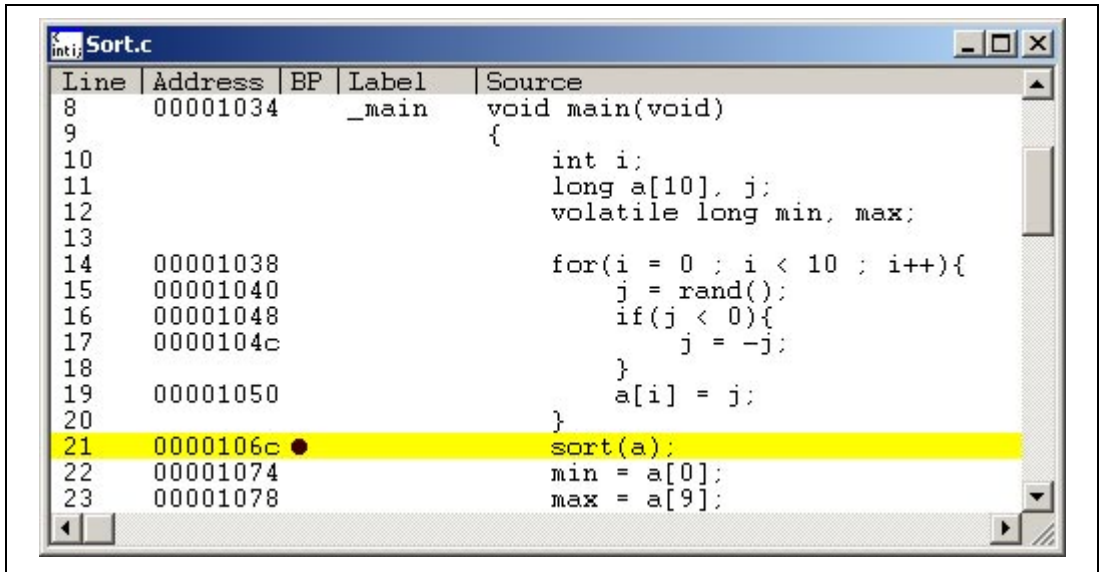

Line	Address	BP	Label	Source
8	00001034		_main	void main(void)
9				{
10				int i;
11				long a[10], j;
12				volatile long min, max;
13				
14	00001038			for(i = 0 ; i < 10 ; i++){
15	00001040			j = rand();
16	00001048			if(j < 0){
17	0000104c			j = -j;
18				}
19	00001050			a[i] = j;
20				}
21	0000106c			sort(a);
22	00001074			min = a[0];
23	00001078			max = a[9];

Figure 4.20 [Source] Window (Step Execution)

4.10.1 Executing [Step In] Command

The [Step In] command steps into the called function and stops at the first line of the function.

- To step into the `sort` function, select [Step In] from the [Run] menu, or click the [Step] button  in the toolbar.

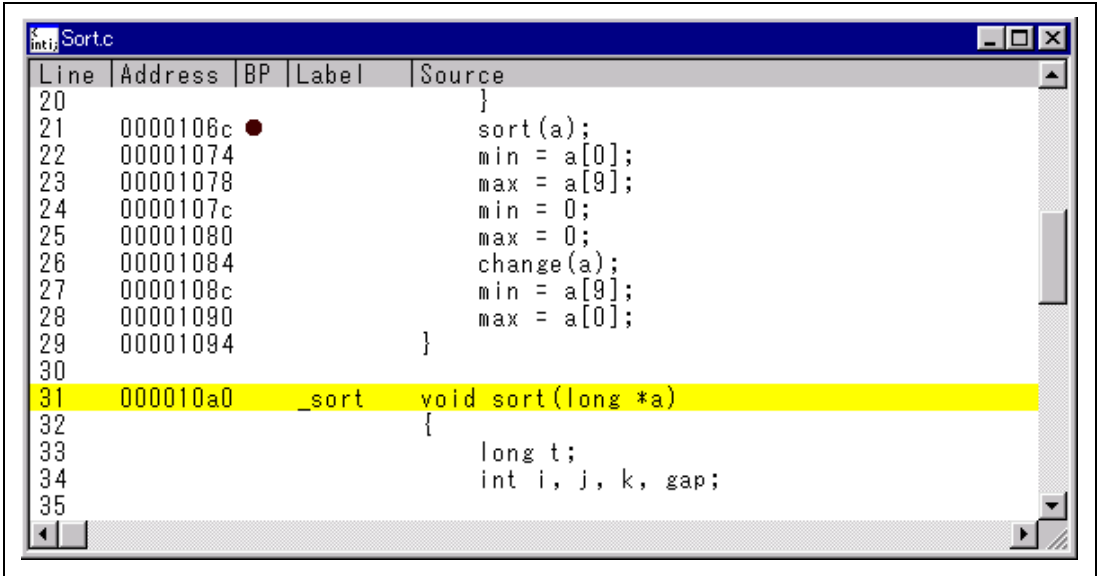

Figure 4.21 [Source] Window (Step In)

The highlighted line moves to the first line of the `sort` function in the [Source] window.

4.10.2 Executing [Step Out] Command

The [Step Out] command steps out of the called function and stops at the next line that called the function in the program.

- To step out of the `sort` function, select [Step Out] from the [Run] menu, or click the [Step Out] button  in the toolbar.

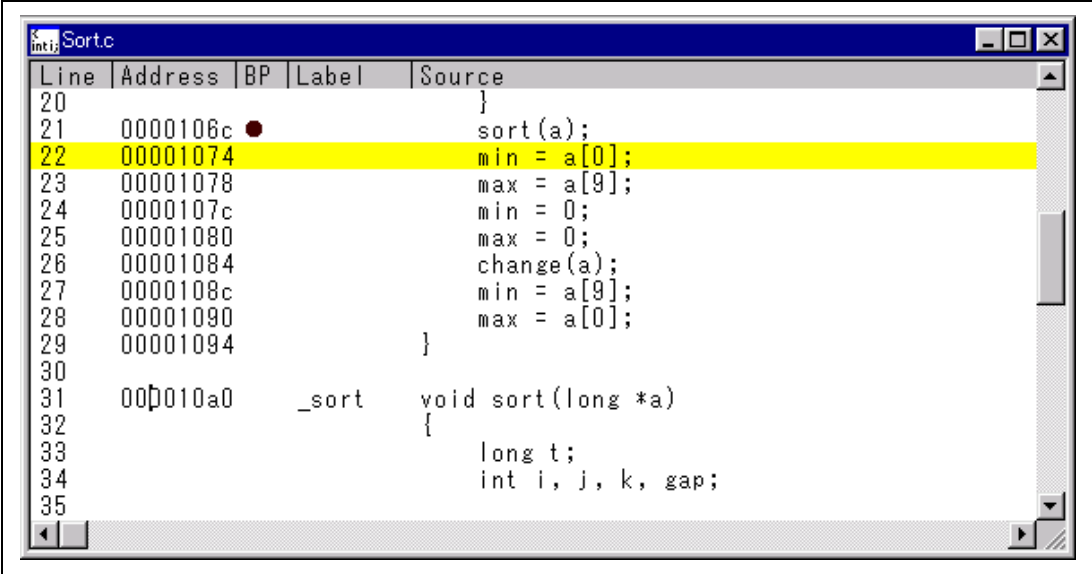

Line	Address	BP	Label	Source
20				}
21	0000106c	●		sort(a);
22	00001074			min = a[0];
23	00001078			max = a[9];
24	0000107c			min = 0;
25	00001080			max = 0;
26	00001084			change(a);
27	0000108c			min = a[9];
28	00001090			max = a[0];
29	00001094			}
30				
31	000010a0		_sort	void sort(long *a)
32				{
33				long t;
34				int i, j, k, gap;
35				

Figure 4.22 [Source] Window (Step Out)

The data of array a displayed in the [Watch Window] window is sorted in ascending order.

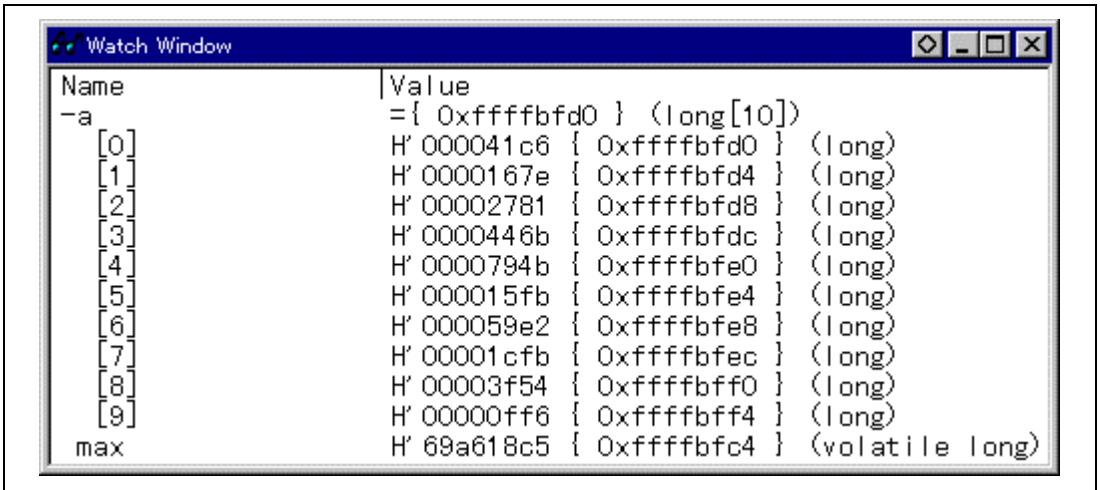

Figure 4.23 [Watch Window] Display Example (1)

To execute two steps, use the [Step In] command twice.

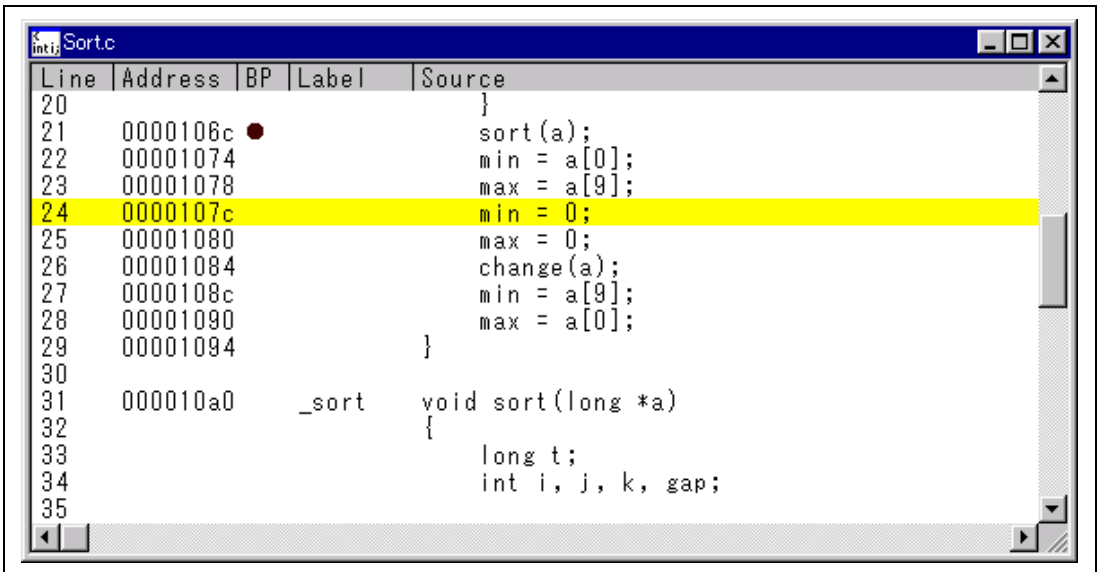

Figure 4.24 [Source] Window (Step Out → Step In)

The value of variable max displayed in the [Watch Window] window is changed to the maximum data value.

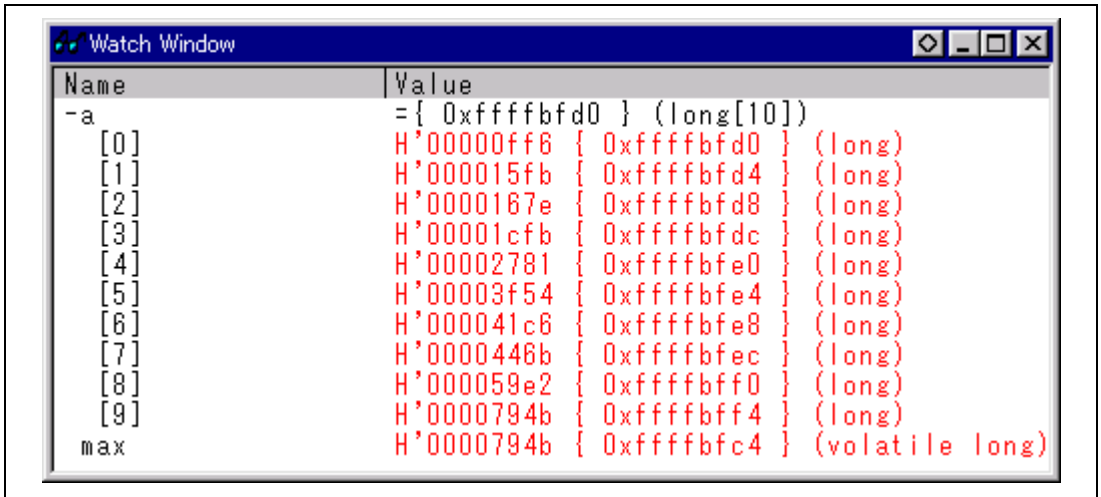
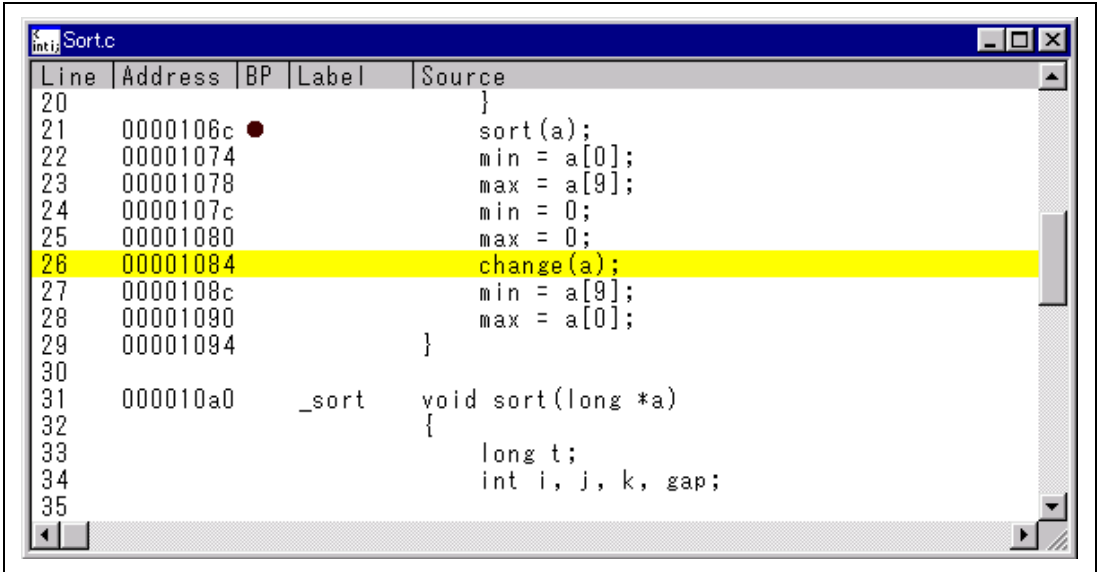

Figure 4.25 [Watch Window] Display Example (2)

4.10.3 Executing [Step Over] Command

The [Step Over] command executes a line that calls a function as a single step.

- Before executing the [Step Over] command, execute two steps up to a line that calls the change function by using the [Step In] command twice.



Line	Address	BP	Label	Source
20				}
21	0000106c	●		sort(a);
22	00001074			min = a[0];
23	00001078			max = a[9];
24	0000107c			min = 0;
25	00001080			max = 0;
26	00001084			change(a);
27	0000108c			min = a[9];
28	00001090			max = a[0];
29	00001094			}
30				
31	000010a0		_sort	void sort(long *a)
32				{
33				long t;
34				int i, j, k, gap;
35				

Figure 4.26 [Source] Window (Before Step Over Execution)

- Select [Step Over] from the [Run] menu, or click the [Step Over] button  in the toolbar.

A line that calls the change function is executed as a single step, and execution stops at the next line in the program.

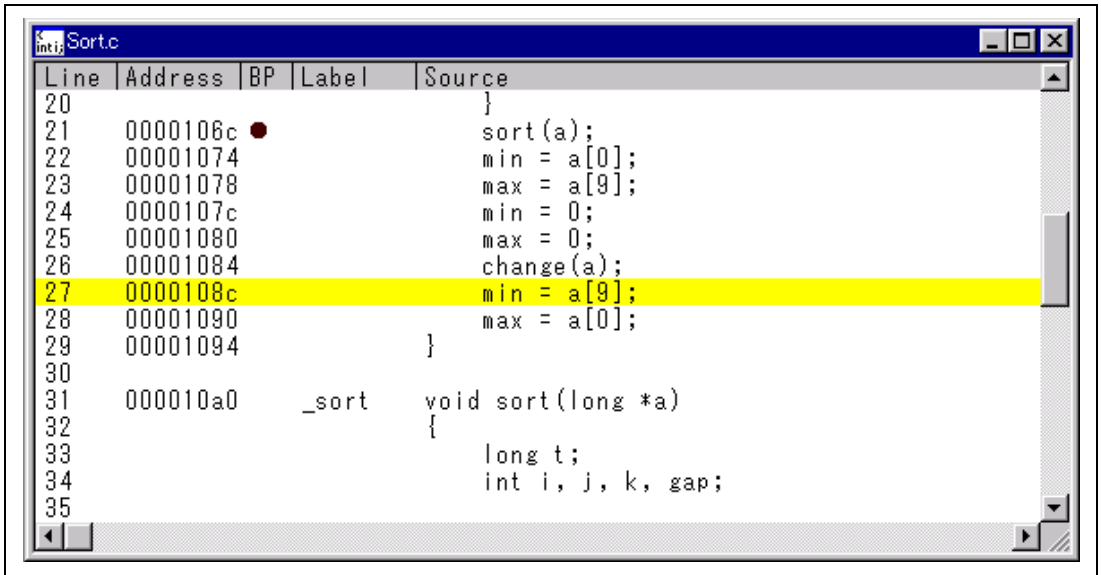

Figure 4.27 [Source] Window (After Step Over Execution)

When the last line of the change function is executed, the data of array a, which is displayed in the [Watch Window] window, is sorted in descending order.

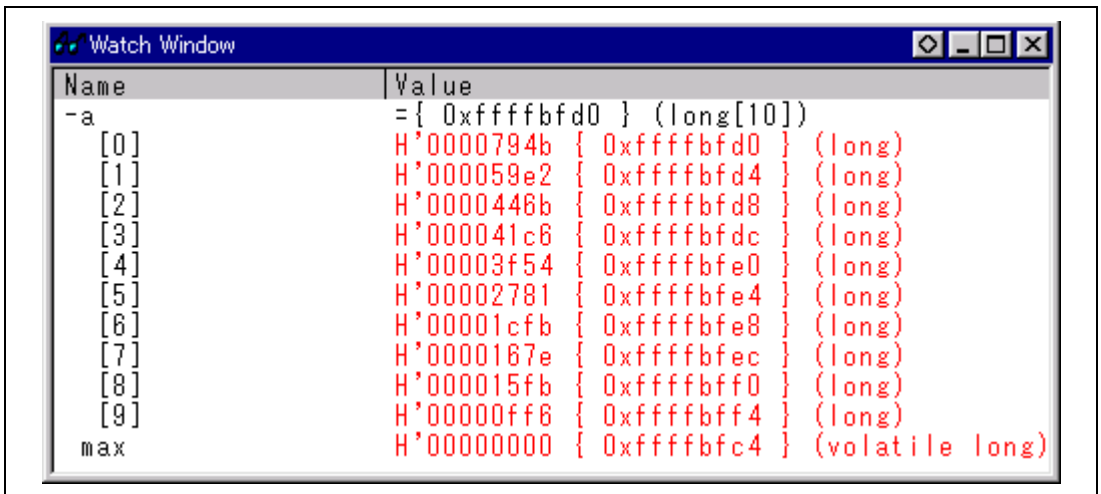

Figure 4.28 [Watch Window] Display Example (3)

4.11 Displaying Local Variables

The user can see local variables in a function using the [Locals] window. For example, the local variables in the main function, which declares five local variables; a, min, max, j, and i will be examined.

Select [Locals] from the [View] menu. The [Locals] window is displayed. When no local variables exist, the [Locals] window is empty.

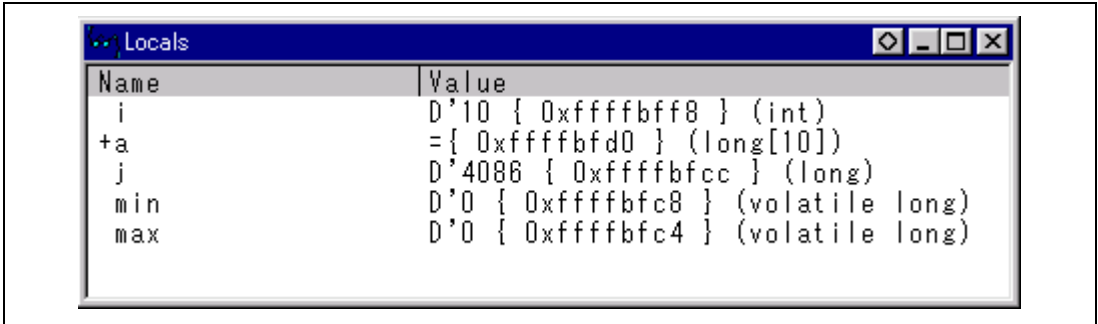

Figure 4.29 [Locals] Window

Double-click the + symbol to the left of array a in the [Locals] window to expand the variable and watch all the elements in the array.

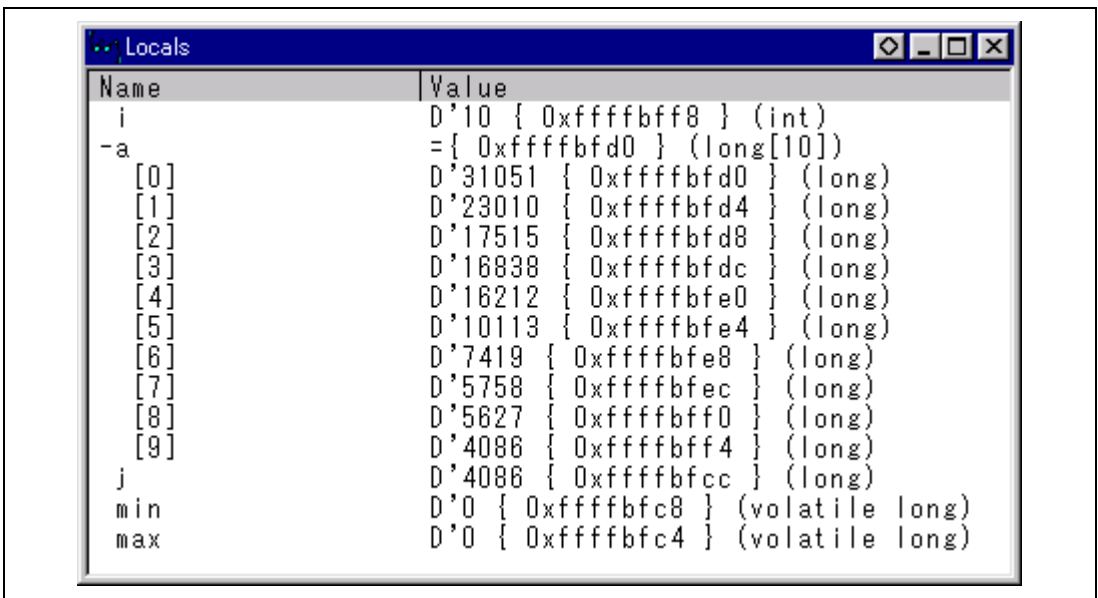

Figure 4.30 [Locals] Window (Displaying Array a Elements)

4.12 Saving and Loading the Session

The information set to the HDI windows and dialog boxes can be saved as a session file. Loading this session file at HDI initialization will allow debugging to be resumed from the same state as the last session.

To save the session file, select [Save Session As...] from the [File] menu. At this time, the window for specifying the file name is displayed. Input the session file name in the window and click the [Save] button.

To load the session file, select [Load Session...] from the [File] menu.

A session file can be automatically saved and loaded by setting the [HDI Options] dialog box of [Options...] in the [Setup] menu.

To automatically save the session file, click on the [Save session automatically] radio button in the [Session] page. The dialog box for specifying the file at HDI termination is then displayed. Specifying the file name enables session information to be automatically saved to the file from the following HDI termination.

To automatically load the session file, enable [Load last session on startup] check box in the [Session] page. The session information is automatically loaded.

For more details on sessions and a setting method, refer to the Hitachi Debugging Interface User's Manual on the CD-R.

Section 5 Emulator Functions

5.1 Introduction

The following is a full description of the emulator's functions, including those that were not described in section 4, Tutorial.

Table 5.1 is a list of the emulator functions that are described in this section.

Table 5.1 Emulator Functions

Section	Function	Description
5.2	Operating mode setting	Sets the operating conditions for the emulator
5.3	Execution	Emulation
5.4	Display of cause for termination and operating status	Displays the cause for emulation termination and the MCU's operating status
5.5	Step execution	Emulation with step execution
5.6	Break	Break functions
5.7	Realtime trace	Acquires, searches for, and displays tracing information
5.8	Execution time measurement	Measures the total execution time of the user program
5.9	Performance analysis	Performance and profile data measurement functions
5.10	Information display	Displays the various items set in each dialog box
5.11	Trigger output	Trigger outputs
5.12	Stack trace	Displays the history of called functions
5.13	Displaying memory and auto-update memory	Displays memory in one of two ways: by parallel access or the auto-update memory display function (the contents of a range of locations is displayed and the display is updated every 500 ms during execution of the user program)
5.14	Entering masks	Formats for the input of masks
5.15	Extended function for [Source] window	Extended functions for the [Source] window of the HDI

5.2 Setting the Emulator's Operating Conditions

The user must set the operating conditions before using the emulator. Table 5.2 lists the settings.

Table 5.2 Setting the Emulator's Operating Conditions

Setting	Item	Description
(Note: Use the [Configuration] dialog box to make these settings.)	MCU setting	Selects the MCU to be used.
	Operating mode setting	Selects the MCU operating mode.
	Clock setting for MCU	Selects the clock to be supplied to the MCU.
	H-UDI (JTAG) clock setting	Selects the clock to be supplied to the H-UDI (JTAG) clock.
	Minimum measurement time setting for the execution-time measurement counter	Selects the measurement unit time for the measurement counter of the execution time.
	Operation setting when using the on-chip flash memory	Sets the operation when the on-chip flash memory is used.
	Operation setting of the emulator function	Enables the use of the emulator function. Interrupt during step execution Selection of the use of the AUD Multibreak mode
	User signal input setting	Enables the use of the user signal input. Enabling the input of the RES signal Enabling the input of the NMI signal Enabling the input of BREQ/WAIT
	Threshold setting for Bus Time Out	Sets the threshold of Bus Time Out.
Threshold setting for user Vcc	Sets the threshold of user Vcc.	
Driver setting	Opens the dialog box to change the driver.	
(Note: Use the [ERam] page to make this setting.)	Mode selection	Selects the mode for the emulation memory.
		Selecting the user RAM mode
		Selecting the emulation memory mode
		Selecting the software-break automatic setting mode for the on-chip ROM area (on-chip flash memory area)

5.2.1 [Configuration] Dialog Box

Select [Configure Platform...] from the [Setup] menu to open the [Configuration] dialog box.

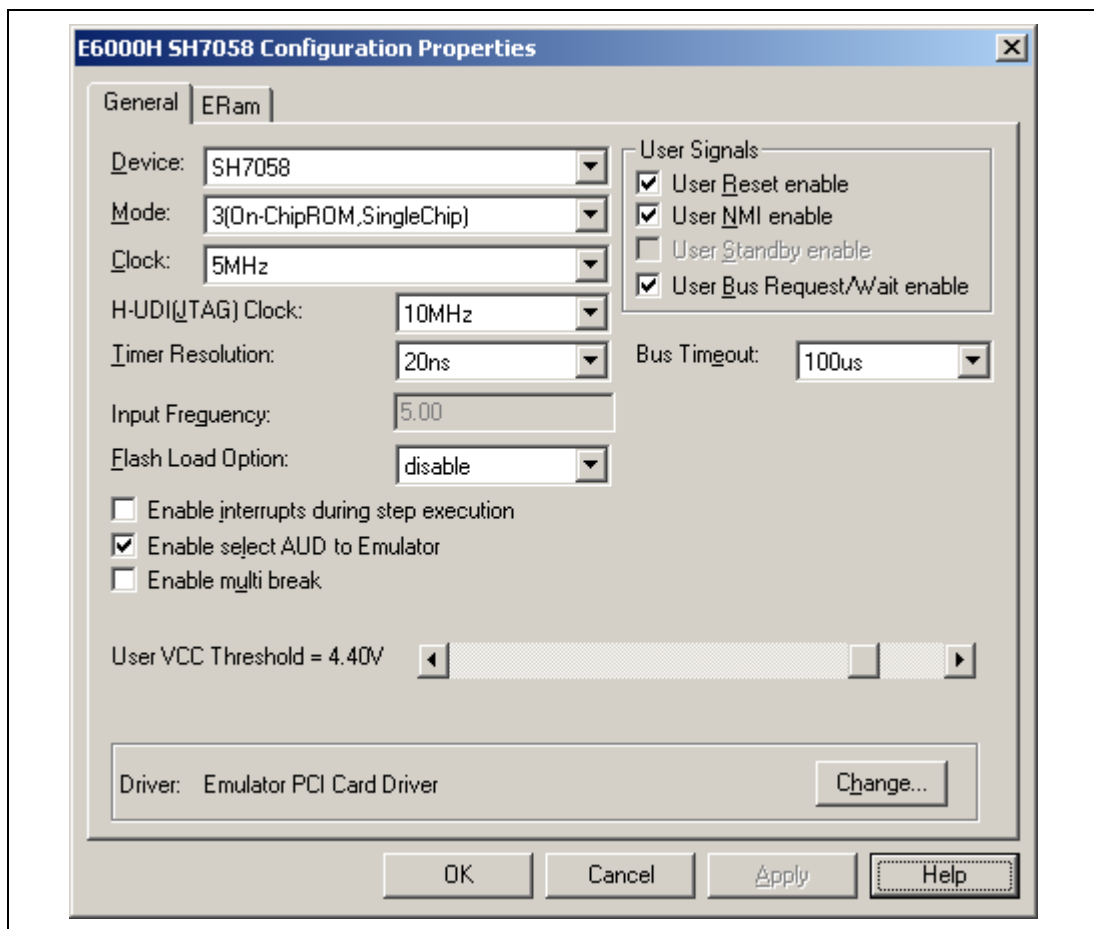

Figure 5.1 [Configuration] Dialog Box

Use this dialog box to set the emulation conditions for the emulator.

Table 5.3 [Configuration] Dialog Box

Page	Description
[General]	Selects the MCU, operating clock, H-UDI (JTAG) clock, the minimum measurement time for the execution-time measurement counter, operation when using the on-chip flash memory, and thresholds of bus time out and user Vcc, sets the mode and the clock when programming the on-chip flash memory, enables emulator operation and the input of the user signal, and displays the dialog box to change the driver
[ERam]	Selects the mode and sets the address for allocating the emulation memory and automatic copy of the on-chip flash memory to the emulation memory

Each page of the [Configuration] dialog box is described below.

[General] Page:

Use this page to select the MCU, operating clock, H-UDI (JTAG) clock, the minimum measurement time for the execution-time measurement counter, and threshold of user Vcc, set the mode, enable emulator operation and the input of the user signal, and display the dialog box to change the driver.

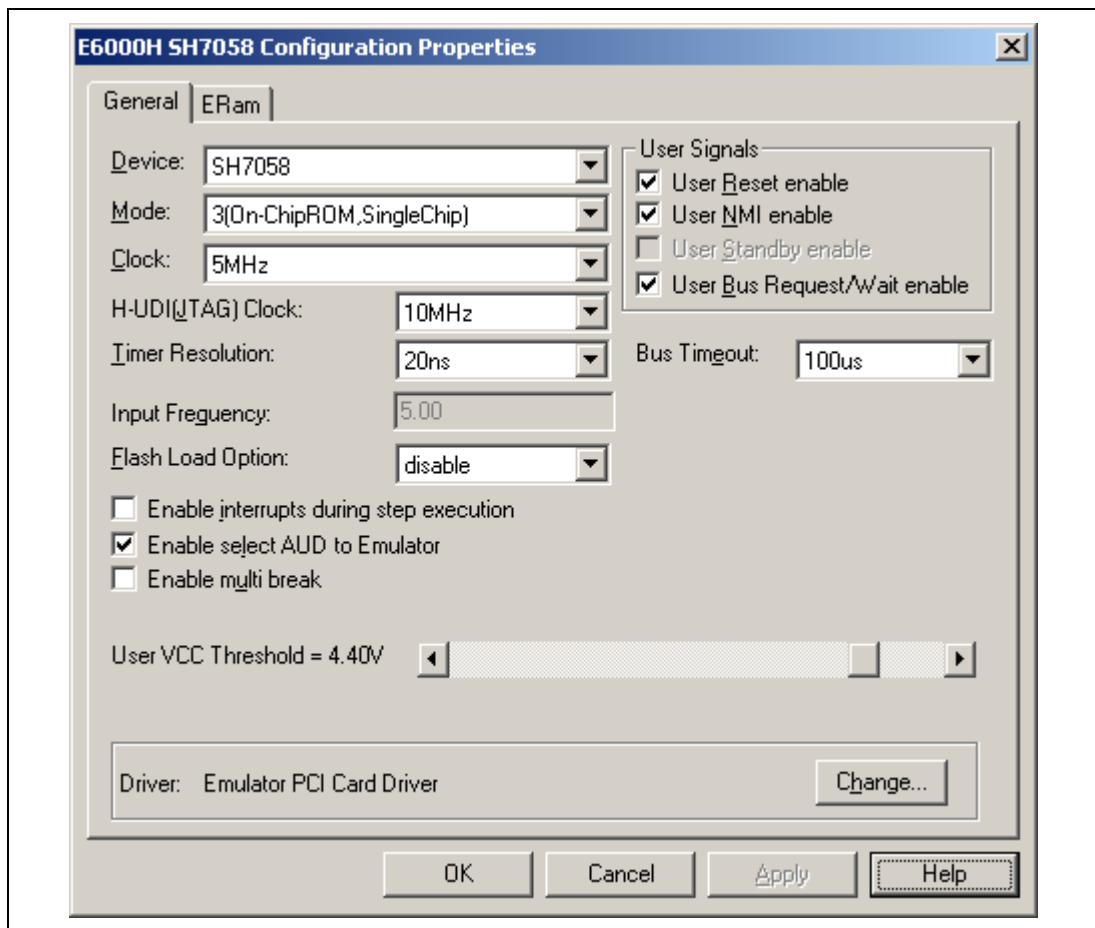

Figure 5.2 [Configuration] Dialog Box ([General] Page)

Table 5.4 [General] Page

Option	Item	Description
[Device]	Selects the MCU	
	SH7xxx	Selects the MCU for emulation
[Mode]	Selects the operating mode for emulation	
	0 (8-bit bus)	MCU expansion mode 0
	1 (16-bit bus)	MCU expansion mode 1
	2 (on-chip ROM)	MCU expansion mode 2
	3 (on-chip ROM, single chip)	MCU single chip mode
	Target	Mode that has been set on the user system
[Clock]	Selects the clock to be supplied to the MCU	
	Emulator Clock (x MHz)	Internal clock (x = 5 MHz or 10 MHz)
	Target clock	Clock signal for the user system
	X'TAL	Crystal oscillator on the evaluation chip
[H-UDI (JTAG) Clock]	Selects the clock to be input to the H-UDI	
	Frequency	Frequency x (x = 10 MHz, 15 MHz, or 20 MHz)
[Timer Resolution]	Selects the execution time or the minimum measurement time width of the counter. The value set here affects the display of the runtime and performance.	
	Runtime measurement	52 us, 1.6 us, or 20 ns
	Clock counter measurement	CLOCK, CLOCK/2, CLOCK/4, or CLOCK/8
[Input Frequency]	Sets the clock when programming the on-chip flash memory. The clock is input when X'tal or Target is specified for [Clock]. The value must be input up to two places of decimals between 5.00 MHz to 10.00 MHz.	
[Flash Load Option]	Sets the operation when programming the on-chip flash memory. disable: Programming disabled update: Programs the on-chip flash memory without initialization erase: Initializes and programs the on-chip flash memory of the target block (4 kbytes) all erase: Initializes and programs all the on-chip flash memory	

Table 5.4 [General] Page (cont)

Option	Item	Description
[User Signals]	User Reset enable	Enables the RES signal from the user system
	User NMI enable	Enables the NMI signal from the user system
	User Bus Request/Wait enable	Enables BREQ or Wait from the user system
[Enable interrupts during step execution]	Specifies whether or not the interrupt is generated during step execution.	
[Enable select AUD to Emulator]	Specifies this option when the AUD is used by the emulator. Remove the check mark when used by the user.	
[Enable multi break]	Specifies whether or not the multibreak is enabled.	
[User VCC Threshold]	Detects the lowered user-system voltage. When the mode is Target, the System Status window informs that the user VCC is lowered than the specified value. When the mode is selected, the initial value is changed. This option also informs when the recommended voltage range is exceeded depending on the mode.	
[Driver...Change]	Specifies the emulator driver. When this dialog box is opened, the emulator is initialized even if the setting is not changed.	

Note: When the check mark for [Enable select AUD to Emulator] is removed and the AUD function is used by the user, memory access is disabled during program execution.

[ERam] Page:

Use this page to select the used mode of emulation memory and to allocate the emulation memory. The emulation memory is mapped to addresses from H'FFFE8000 to H'FFFEFFFF, and used for on-chip ROM emulation. The addresses H'FFFE8000 to H'FFFEFFFF can also be used for on-chip RAM. In the actual MCU, the emulation memory is reserved and not installed.

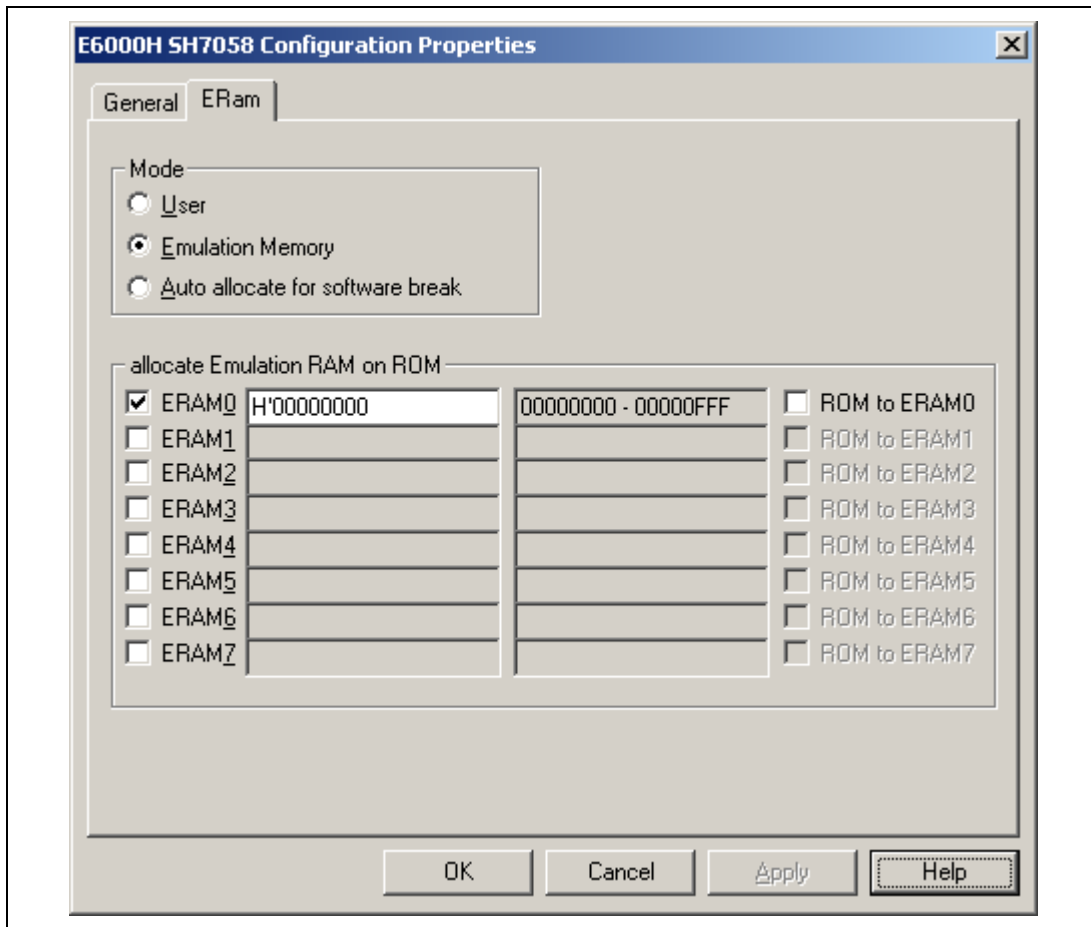

Figure 5.3 [Configuration] Dialog Box ([ERam] Page)

Table 5.5 [ERam] Page

Option	Description
[Mode]	Selects the ERAM mode to be used.
[User]	Uses the emulation memory for on-chip RAM. Addresses from H'FFFE8000 to H'FFFEFFFF can be used as the on-chip RAM.
[Emulation Memory]	Performs on-chip ROM emulation. The ROM area (on-chip flash memory area) to be emulated is allocated to the address by the [Emulation RAM].
[Auto allocate for software break]	Sets the mode to automatically emulate the on-chip ROM when a software break is set on the on-chip ROM.
[allocate Emulation RAM on ROM]	When the emulation memory is selected with [Mode], selects the ERAM area and sets the ROM area address to be emulated.
ERAM 0 to 7	Selects the ERAM to be allocated.
Address input	Inputs the start address of ROM to be emulated. When a value is set outside the 4-kbyte boundary, round down the value below the boundary.
Set range address display	Displays the address range of ROM to be emulated.
Checkbox for automatic writing to the on-chip flash memory	When this checkbox is checked, the contents of the on-chip flash memory are read and written to the emulation memory when the emulation memory is allocated. When the user program is downloaded to the on-chip flash memory in this state, the program is also downloaded to the emulation memory.

Note: Stop the DMAC operation when the emulation memory is set.

[User] Mode:

The emulation memory is used as the on-chip RAM. The addresses from H'FFFE8000 to H'FFFEFFFF can be used as the on-chip RAM. Figure 5.4 shows the selection in [User] mode, and figure 5.5 shows the emulation memory diagram when the [User] mode is selected.

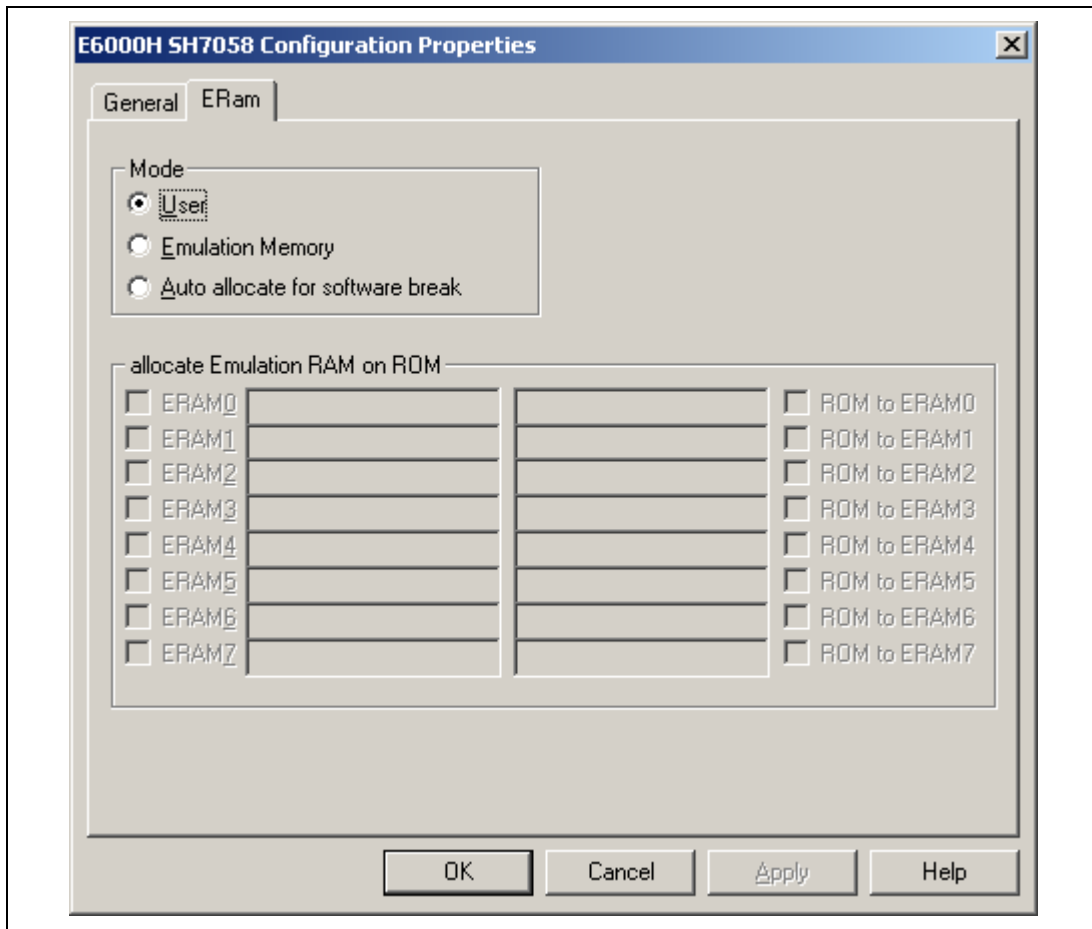

Figure 5.4 [User] Mode in [ERam] Page

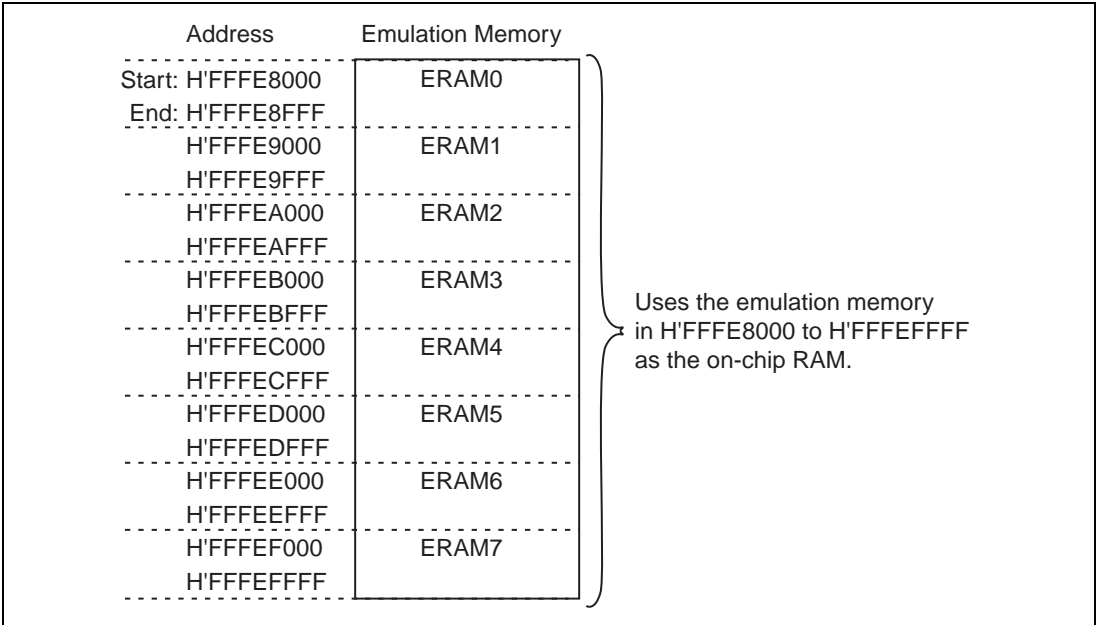

Figure 5.5 Diagram for Emulation Memory in [User] Mode

[Emulation Memory] Mode:

The ERAM area can be used for the emulation of the ROM area (on-chip flash memory area). The emulation memory can be allocated in 4-kbyte boundaries. The ROM contents can be downloaded to ERAM automatically, and the ERAM contents can also be downloaded to the ROM area (on-chip flash memory) automatically.

(a) Emulation Memory Allocation

Figure 5.6 shows the display when the ROM area from H'00000000 to H'00000FFF, and H'00001000 to H'00001FFF are allocated to ERAM0 and ERAM1, respectively. Figure 5.7 shows the diagram.

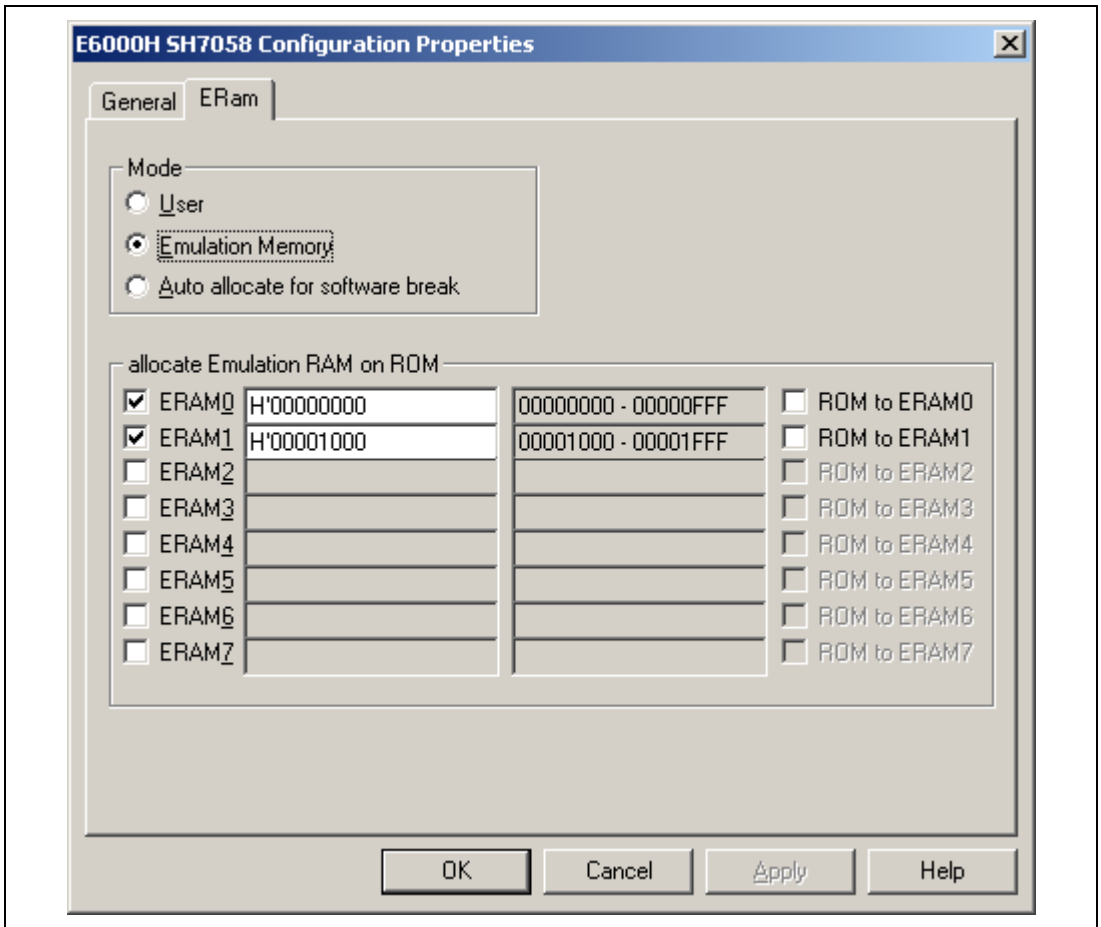

Figure 5.6 Allocation to ERAM0 and ERAM1 Display

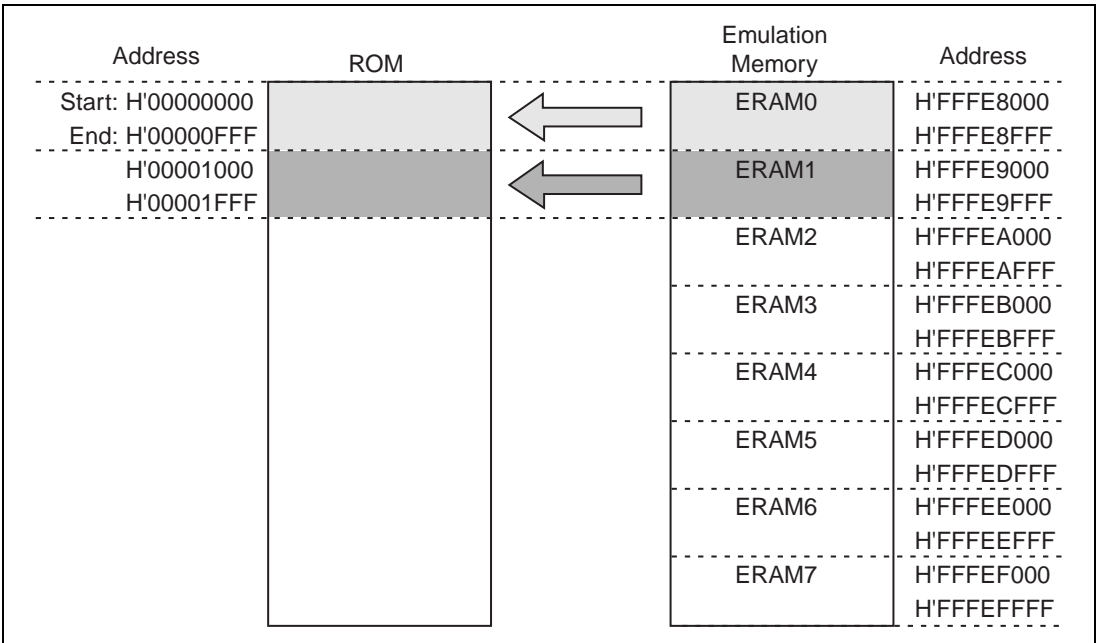

Figure 5.7 Diagram for Allocation to ERAM0 and ERAM1

Figure 5.8 shows the display when the ROM area from H'00000000 to H'00000FFF is allocated to ERAM4, and H'00002000 to H'00002FFF to ERAM0, respectively. Figure 5.9 shows the diagram.

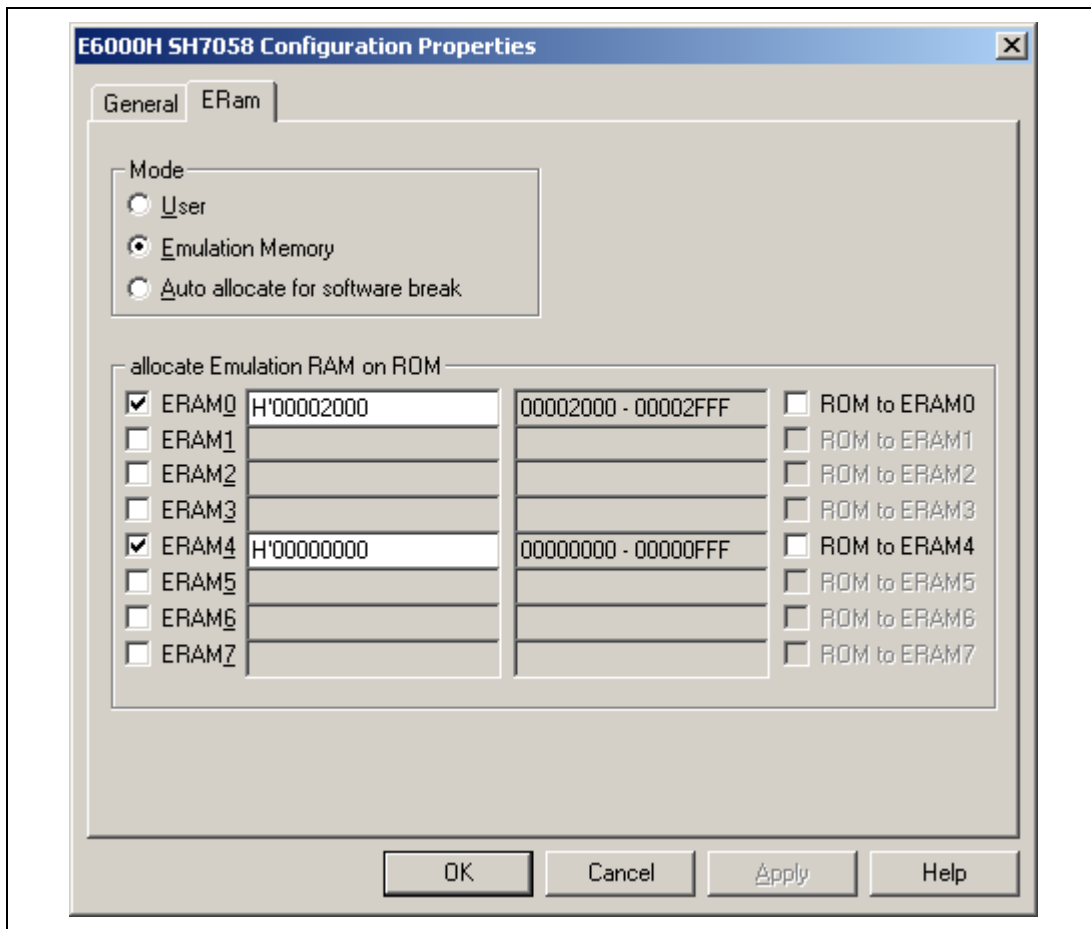

Figure 5.8 Allocation to ERAM4 and ERAM0 Display

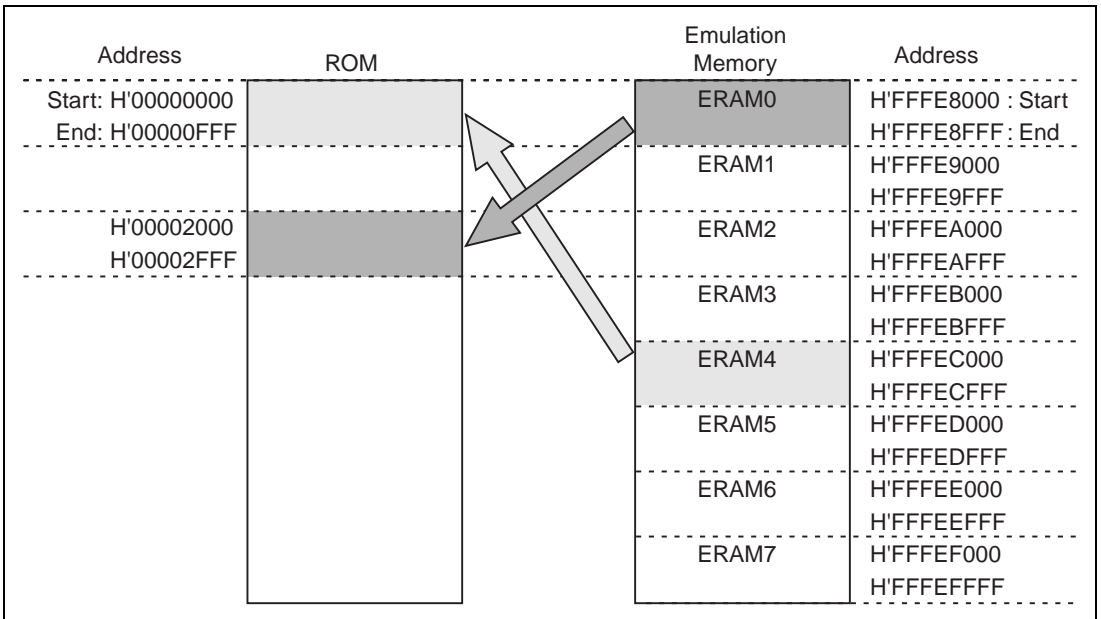

Figure 5.9 Diagram for Allocation to ERAM4 and ERAM0

(b) Automatically Copying ROM Contents to ERAM

Figure 5.10 shows the setting when the ROM area from addresses H'00000000 to H'00000FFF and H'00001000 to H'00001FFF are allocated to ERAM0 and ERAM1, respectively, then automatically copying the ROM area from addresses H'00000000 to H'00000FFF contents to ERAM0.

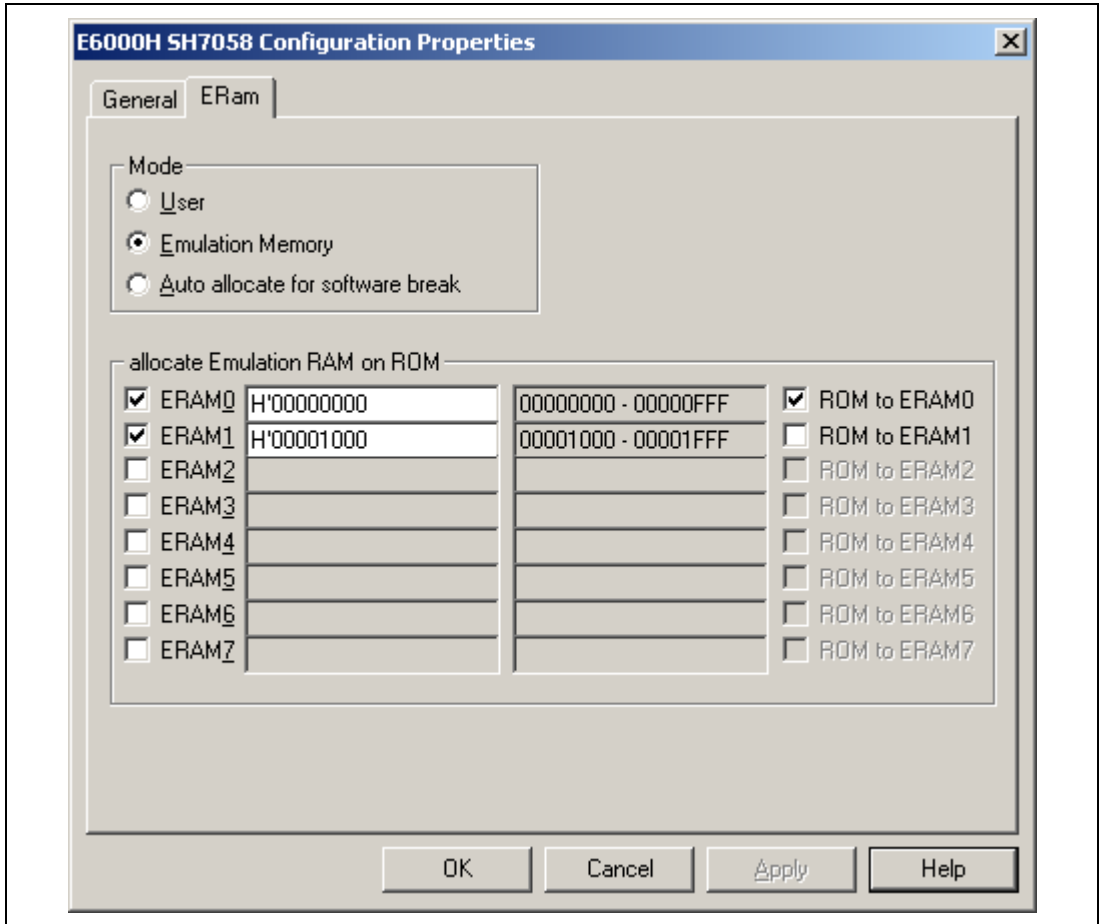

Figure 5.10 Automatically Copying ROM Contents to ERAM0

As shown in figure 5.10, when the [ROM to ERAM n ($n = 0$ to 7)] checkbox on the right side of the [allocate Emulation RAM on ROM] group box is checked and [OK] is clicked, the contents of the on-chip ROM are written to the area that has been emulated by the specified ERAM.

(c) Automatically Writing (Copying) ERAM Contents to the ROM Area (On-chip Flash Memory)

When the ERAM is released to the user, the automatic writing (copying) ERAM contents to ROM area (on-chip flash memory) is enabled. As shown in figure 5.6, when the ROM area from addresses H'00000000 to H'00000FFF and H'00001000 to H'00001FFF are allocated to ERAM0 and ERAM1, respectively, and ERAM0 and ERAM1 is released, the display is as shown in figure 5.11. Figure 5.12 shows the selection for automatically writing (copying) ERAM contents to ROM area (on-chip flash memory).

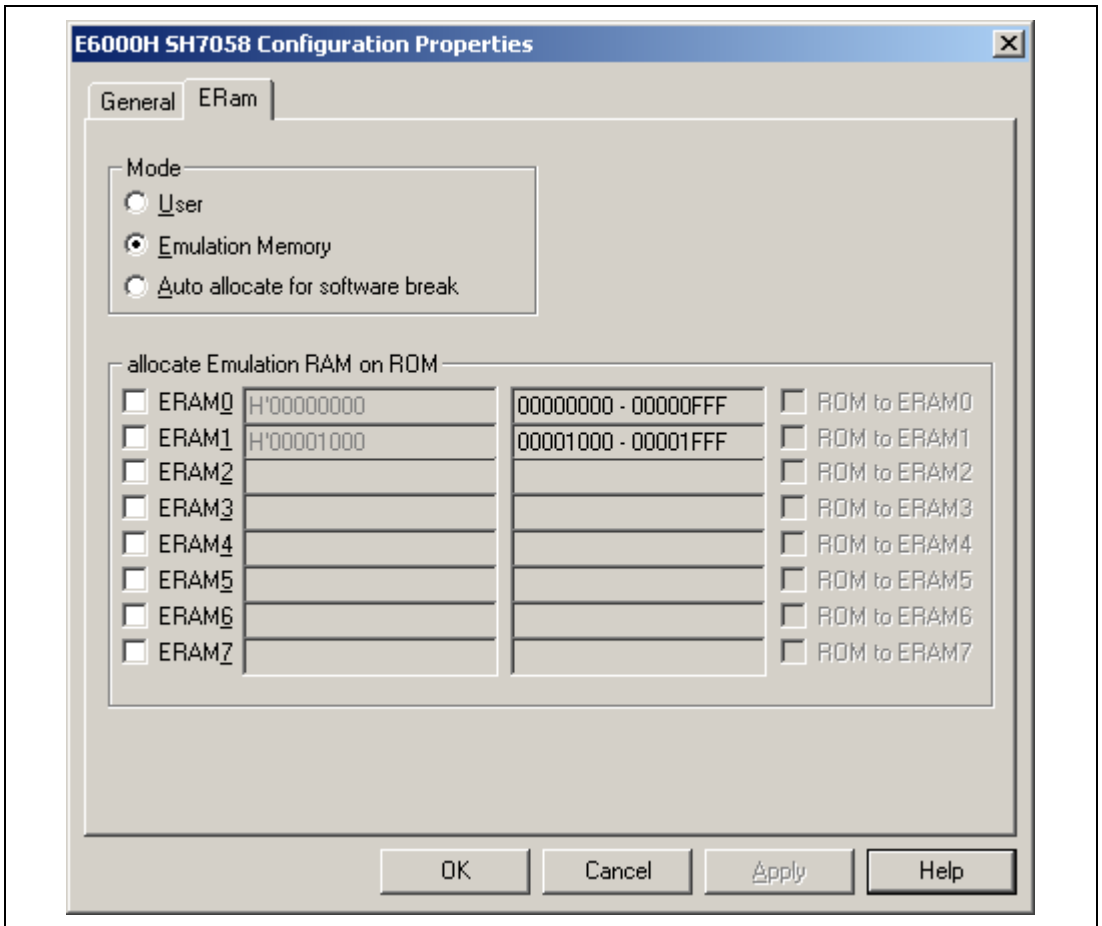

Figure 5.11 Releasing ERAM0 and ERAM1

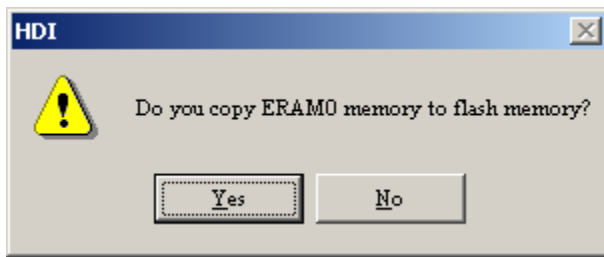

Figure 5.12 Selection of Automatic Downloading of ERAM contents to ROM Area (On-chip Flash Memory)

As shown in figure 5.11, remove the checking in the checkbox on the left side of the [allocate Emulation RAM on ROM] group box, and click [OK]. When the check is removed, the display shows the selection whether or not to write the ERAM contents to on-chip ROM (on-chip flash memory) for each ERAM area, so click [Yes] or [No].

[Auto allocate for software break] Mode:

When a software break is set for the ROM area in the [Auto allocate for software break] mode, the ERAM area is automatically used to emulate the ROM area including the address where the software break has been set. This function enables automatically setting the software break to the ROM area without setting the area to be emulated. The emulation memory is allocated in 4-kbyte boundaries. Figure 5.13 shows the setting of the [Auto allocate for software break] mode.

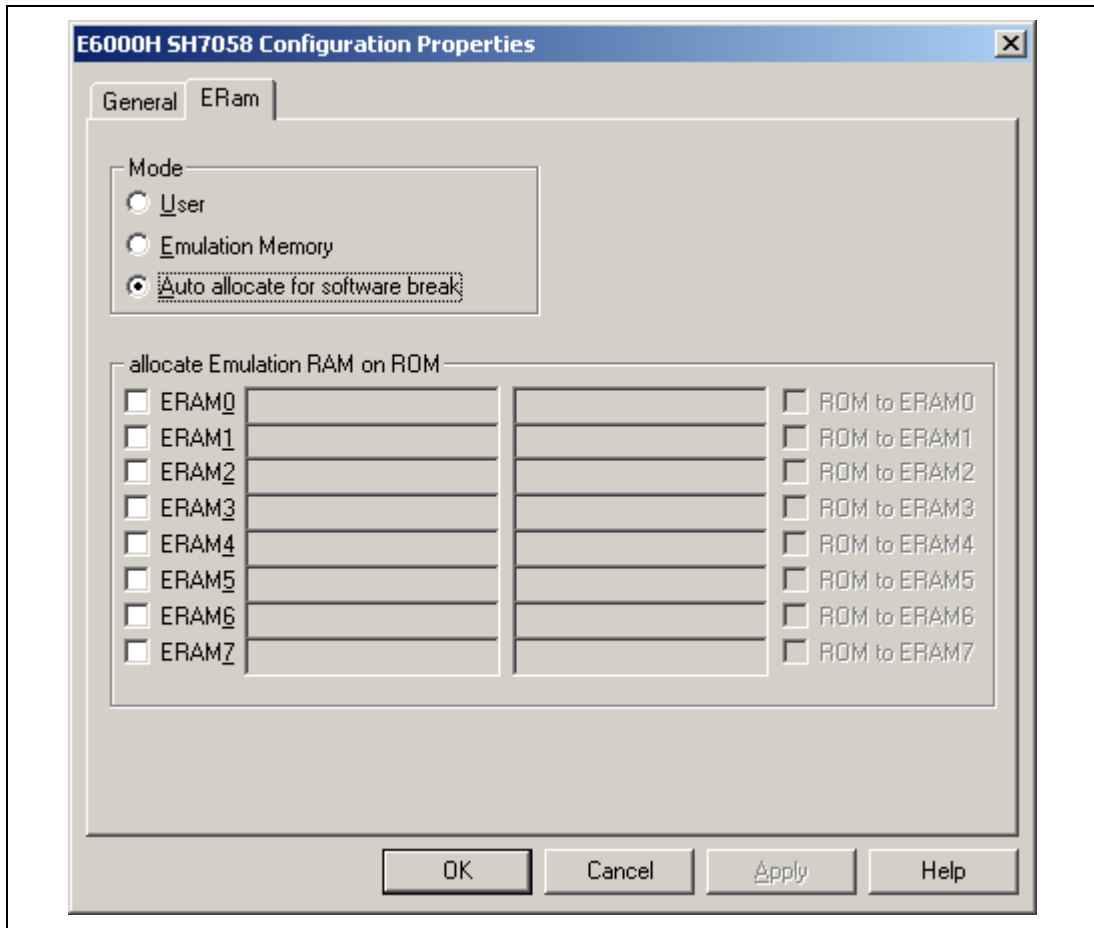

Figure 5.13 Selection of the [Auto allocate for software break] Mode in [ERam] Page

5.3 Program Execution

5.3.1 Execution

Table 5.6 shows the main forms of program execution.

Table 5.6 Program Execution

Form	Function	Procedure
Normal execution	Executes the user program from the current PC (program counter) address.	Click the [Go] button Select [Go] from the [Run] menu
Execution from the reset vector	Inputs the RES signal to the MCU, then executes the user program from the reset vector.	Click the [Reset Go] button Select [Reset Go] from the [Run] menu
Setting a program counter to a specified address	Sets the program counter to the specified address.	Place the mouse cursor on the [Source] window. Then click the [Set PC Here] button or select [Set PC to Cursor] from the [Run] menu
Execution to a specified address	Executes the user program to the specified address. Specifies the end address, and executes the user program up to that address.	Place the mouse cursor on the [Source] window. Then click the [Go to Cursor] button or select [Go to Cursor] from the [Run] menu Select [Run...] from the [Run] menu, specify a start address for [Program Counter] in the [Run] dialog box, specify an end address for [Stop At] in the [Run] dialog box, then click the [Go PC] button. More than one address can be specified as an end address.

Note: The function, which is executed by placing the mouse cursor on the specified address in the [Source] window and then selecting the [Go to Cursor] button, or by selecting [Go to Cursor] from the [Run] menu, uses a channel for the on-chip break. Therefore, when 12 channels of the on-chip break are used with the break condition, this function cannot be used.

5.4 Display of Cause for Termination and Operating Status

Cause for Termination: When emulation is terminated, the cause of termination is displayed as the [Cause of last break] on the [Platform] sheet in the [System Status] window, and on the HDI window's status bar.

Table 5.7 is a list of the messages that indicate the various causes for termination.

Table 5.7 Causes for Termination

Display	Meaning
User Break	A forced break has been issued via the [STOP] button or [Halt] from the [Run] menu.
Software Break	The break was triggered by a software break.
On Chip Channel n ($n = 1$ to 12)	The break was triggered by an on-chip break.
On Emulator Break	The break was triggered by an on-emulator break.
Stepping Completed	A step execution has been completed.
Stepping Aborted	A step execution has been aborted.
Performance Break	The break was triggered by performance analysis.
Invalid breakpoint	The break was triggered by an instruction other than PC Break.

Operating Status Display: While the user program is in execution, the MCU's operating status is monitored and displayed on the HDI window's status bar. This function allows the user to observe the progress of the program. The display is only updated when the status changes.

Table 5.8 is a list of the operating status messages.

Table 5.8 Operating Status Display

Display	Meaning
Address=xxxxxxx	During execution of the user program, the address from which operations are fetched is displayed here.
Reset	The MCU has been reset. The RES signal is low.
Running	Execution of the user program has been initiated. This message is displayed once the execution has been started or restarted. Note that this message is deleted when Address=xxxxxxx starts to be displayed.
Status=SLEEP	The MCU is in its sleep mode
Status=Bus Timeout WAIT signal = Low	The WAIT signal is low.
Status=BREQ	This status is displayed when the BREQ signal is low.
Status=BUSREL	The MCU is in its bus release mode.
Status=STANBY	The MCU is in its hardware or software standby mode.
Status=Bus Timeout RES signal = Low	The RESET pin is low.
Status=VCC Down	The VCC is lower than the value that has been set.

5.5 Step Functions

5.5.1 Step Execution

Several types of step execution are available, and are shown in table 5.9.

Table 5.9 Step Execution

Type	Description	Procedure
Executing each instruction of a function as a single step	Executes each line or instruction as one step. When a function is called, the call is executed, and execution stops at the first line or instruction of the called function.	Click the [Step] button. Select [Step In] from the [Run] menu.
Executing all instructions of a function as a single step	Executes each line or instruction as one step. When a function is called, all instructions of the called function are executed as a single step, and execution stops at the line or instruction immediately after the calling line or instruction. The instructions are executed only in the RAM area on the user system and the area that the emulation memory has been allocated.	Click the [Step Over] button. Select [Step Over] from the [Run] menu.
Executing a specified number of steps	Executes the specified number of steps. Note that the specified address must be the start of an instruction. If, for example, the address of the second byte of an instruction is specified, execution will not stop, and the specified number of steps will still be executed.	Click the [Step dialog] button, specify the number of steps in [Steps] in the [Step Program] dialog box, and start execution. Selecting [Step Over Calls] allows a function call to be executed as a single step. Select [Step...] from the [Run] menu. The settings are the same as above.
Stopping function execution	Steps out of a function. Execution stops at the line after the calling line in the program.	Click the [Step Out] button. Select [Step Out] from the [Run] menu.

Note: Breaks become disabled during step execution. However, the trigger is output.

5.5.2 Accepting Interrupts during Step Execution

Interrupts cannot normally be accepted during step execution. Select [Enable interrupts during step execution] from the [General] page of the [Configuration] dialog box if you want interrupts to be accepted during step execution.

5.6 Break Functions

The emulator provides break function shown in table 5.10. The HDI displays a list of breakpoints in the [Breakpoints] window, and the break conditions are specified in the dialog boxes for break functions.

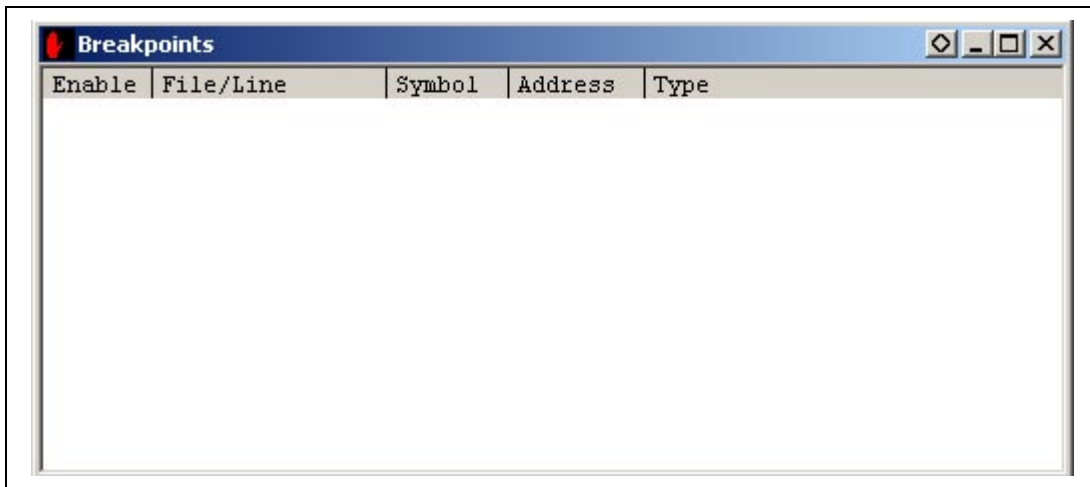

Figure 5.14 [Breakpoints] Window

For details on the [Breakpoints] window, refer to the Hitachi Debugging Interface User's Manual (on the CD-R).

Table 5.10 Break Functions

Type	Description
On-chip break	A break function incorporated in the MCU. When a condition set for On Chip Break Channel n ($n = 1$ to 12) has been satisfied, a break occurs. "OnChip" is displayed under Type in the [Breakpoints] window.
On-chip sequential break	When all of the conditions have been satisfied in the specified order of the on-chip break conditions, a break occurs. On Chip Break Channel 1 to 8 can be used for four- or eight-level sequential break conditions. On Chip Break Channel Reset is used as a reset point for the sequential break condition (can be set only for On Chip Break Channel 8).
On-emulator break	This type of break is generated by the dedicated hardware in the emulator. Conditions can be set to On Emulator Break, and when one of these conditions has been satisfied, a break occurs. "OnEmulator" is displayed under Type in the [Breakpoints] window.
Software break	The contents of the specified address are replaced by a break instruction (a dedicated instruction for use with the emulator), and the program is then executed. When the break instruction is executed, a break occurs. "Software" is displayed under Type in the [Breakpoints] window.
Forced break	This is the break for the forcible termination of a program that is issued when the [STOP] button on the toolbar is pressed.
Break due to trace buffer overflow	This break occurs when the trace buffer in the emulator overflows during trace acquisition.

- Notes:
1. The [Enable] column in the [Breakpoints] window displays ● only when On Chip Break is selected and the Bus/Area condition is Instruction prefetch. When BREAKPOINT is set in other conditions, ○ is displayed.
 2. During user program execution, it is not possible to jump the corresponding source line (or address line) on the [Source] or [Disassemble] window from the breakpoint by using [Go to Source] in the pop-up menu on the [Breakpoints] window.

5.6.1 On-Chip Break

Overview: These break functions built in the MCU. The on-chip break conditions are shown in table 5.11. These conditions are satisfied when all of its specified conditions are satisfied (an AND condition).

Table 5.11 On-Chip Break Conditions

Break Condition	Description
Address bus	Satisfied when the address value matches the specified value.
Data bus	Satisfied when the data value matches the specified value.
Bus/Area	Satisfied when the specified access type, bus status, and read/write cycle conditions are matched. When no condition is set, all bus cycles, including program-fetch cycles, satisfy the condition.
Satisfaction count	This condition is specified in combination with some other conditions. The break occurs when the specified condition has been satisfied the specified number of times.
Reset point	Specifies the reset point condition. This condition is available only for On Chip Break Channel 8.
Operating	Specifies the operation when the condition has been satisfied.

The on-chip break uses 12 channels independently and is used as the PC breakpoint that is set by double-clicking the [Source], [Disassembly], or [Label] window. When there is an empty channel, the PC breakpoint that is set by double-clicking is set for that channel. When there is no empty channel, the empty channel for the software break is used as the PC breakpoint. However, in this case, the PC breakpoint cannot be set in the on-chip ROM area (on-chip flash memory area).

When the software breakpoint is set in the on-chip ROM area, emulate the ROM area by using the ERAM.

Setting an On-Chip Break: The setting of On Chip Break 8 is taken as an example.

Select [Edit...] from the pop-up menu in the [Breakpoints] window, and the dialog box (figure 5.15) will appear. Click the [On Chip Break] tab to select the [On Chip Break] page.

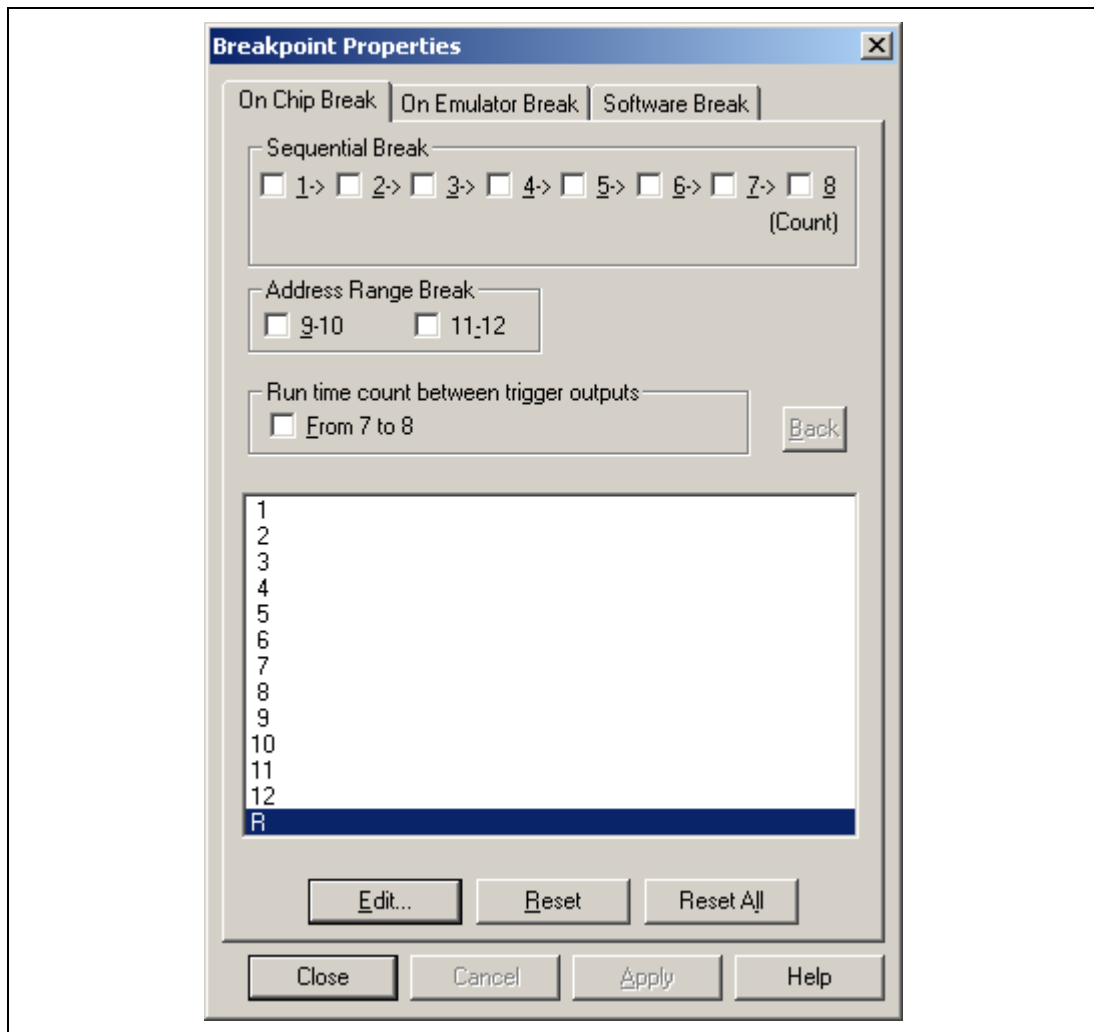

Figure 5.15 [Breakpoint Properties] Dialog Box ([On Chip Break] Page)

Table 5.12 [On Chip Break] Dialog Box Options

Option	Description
[Sequential Break]	Specifies On Chip Break 1 to 8 and the order of halting a breakpoint. Channels are specified in a sequential order.
[Address Range Break]	Specifies the combination of channels and the range of halting a break. For channels, select the following: 9-10: Channels 9 and 10 are used to specify the range of break. 11-12: Channels 11 and 12 are used to specify the range of break.
[Point To Point Time Measurement]	Measures a time between two points by using channels 7 and 8. After channel 7 has been satisfied, the time is measured when channel 8 is satisfied. The measured result is displayed in PtoP Time Count in the [System Status] window, which is EORed to RunTime Count.
[Back]	Puts the setting back when the dialog box has been displayed.
[Edit...]	Modifies the setting selected in the [Condition] list box. Clicking this button opens the [On Chip Break <i>n</i>] dialog box. (<i>n</i> : channel number.)
[Reset]	Clears the settings on the On Chip Break page selected in the [Condition] list box.
[Reset All]	Clears all settings on the On Chip Break page in the [Condition] list box.

Double-click 8 in the list box by using a mouse. Click the [Edit...] button to open the [On Chip Break 8] dialog box.

Close the [On Chip Break 8] dialog box and the display returns to the [On Chip Break] dialog box. The contents of the on-chip break condition set to 8 in the list box are displayed. Click the [OK] button to close the [On Chip Break] dialog box.

On-chip break conditions are specified for the other channels in the same way.

The following sections describe each page.

(a) [Address] Page

Use this page to specify the address bus conditions.

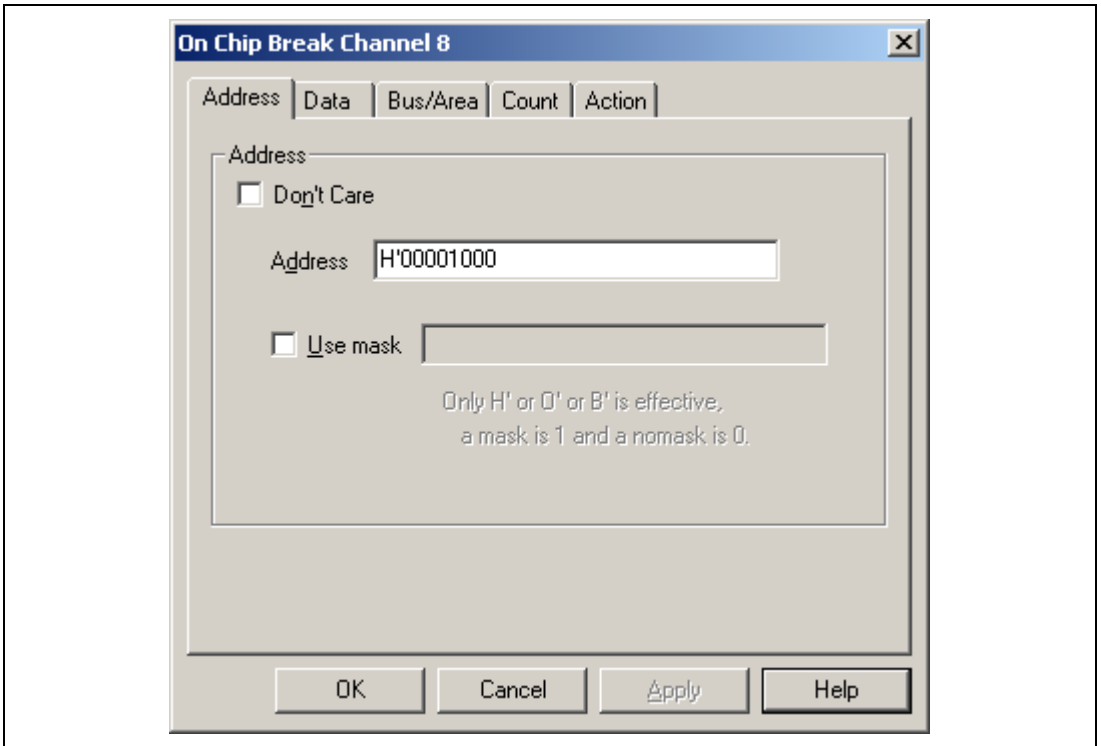

Figure 5.16 [On Chip Break Channel 8] Dialog Box ([Address] Page)

Table 5.13 [Address] Page Options

Option	Description
[Don't Care]	Selects no address bus condition.
[Address]	Select this button to set the address bus value specified in [Start] as the break condition.
[User mask]	Sets mask conditions. Sets the mask bits if [User mask] is selected. Masked bits satisfy this break condition regardless of their values.

- Notes: 1. Set a multiple of two as the address value when the 16-bit area is accessed.
2. Set a multiple of four as the address value when the 32-bit area is accessed.

(b) [Data] Page

Use this page to specify the data bus conditions.

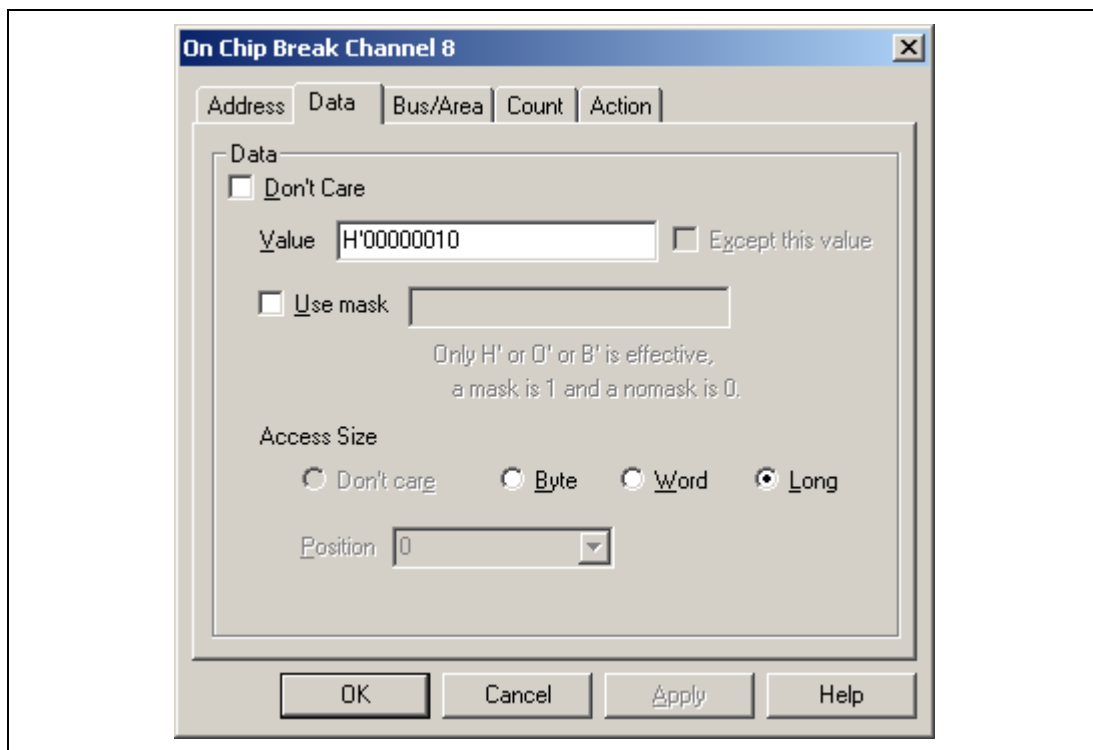

Figure 5.17 [On Chip Break Channel 8] Dialog Box ([Data] Page)

Table 5.14 [Data] Page Options

Option	Description
[Don't Care]	Sets no data bus condition.
[Value]	Sets a data bus value as a number.
[Access Size]	<p>Specifies the data-access size.</p> <p>[Byte]: Sets byte-data-access cycles.</p> <p>[Word]: Sets word-data-access cycles.</p> <p>[Long]: Sets longword-data-access cycles.</p> <p>[Position]: Sets a data bus value as a number. The position of the valid data bus is specified.</p> <p style="padding-left: 40px;">[Long]: None</p> <p style="padding-left: 40px;">[Word]: 4n: Upper word 4n + 2: Lower word</p> <p style="padding-left: 40px;">[Byte]: 4n: Upper byte of the upper word 4n + 1: Lower byte of the upper word 4n + 2: Upper byte of the lower word 4n + 3: Lower byte of the lower word</p>
[Use Mask]	Sets mask conditions. Sets the mask bits if [User mask] is selected. Masked bits on the data bus satisfy this break condition regardless of their values.

Use this page to specify conditions for the read or write cycle and access type.

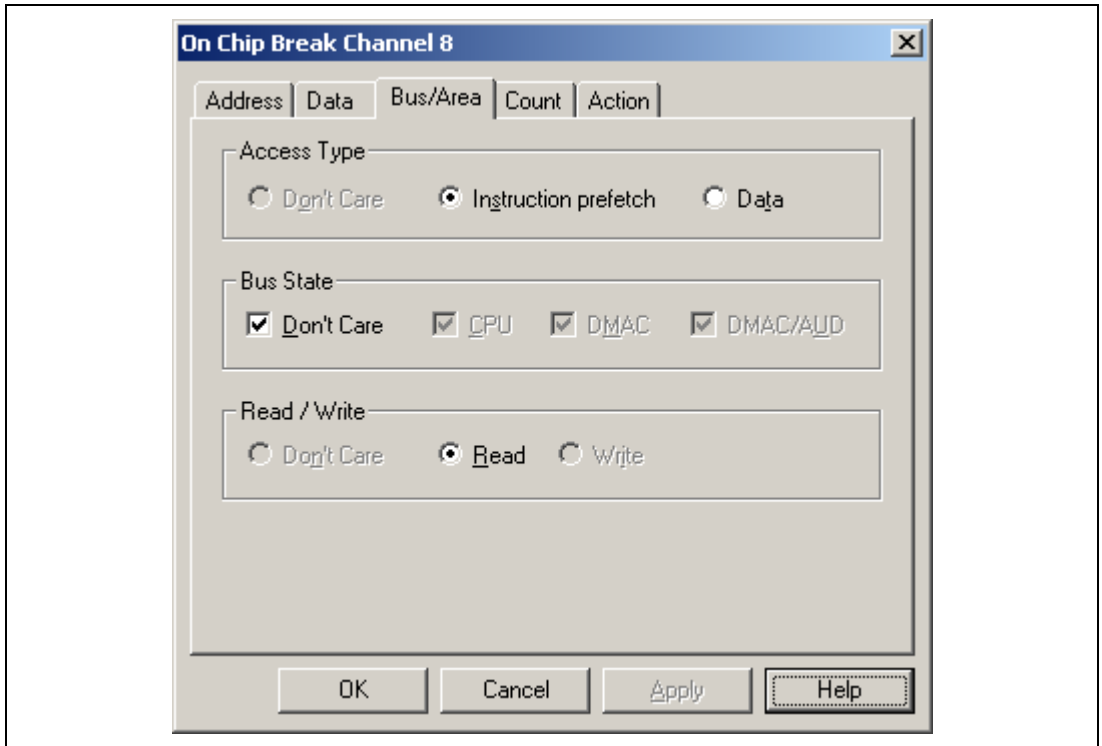

Figure 5.18 [On Chip Break Channel 8] Dialog Box ([Bus State] Page)

Table 5.15 [Bus State] Page Options

[Access Type] Group Box

Option	Description
[Instruction prefetch]	Instruction prefetch cycles satisfy this condition.
[Data]	Data access cycles satisfy this condition.

[Bus State] Group Box

Option	Description
[Don't Care]	All cycles satisfy this condition.
[CPU]	CPU cycles satisfy this condition.
[DMAC]	DMAC cycles satisfy this condition.

[Read/Write] Group Box

Option	Description
[Don't Care]	Both of read and write cycles satisfy this condition.
[Read]	Read cycles satisfy this condition.
[Write]	Write cycles satisfy this condition.

(d) [Count] Page

Use this page to specify a satisfaction count condition.

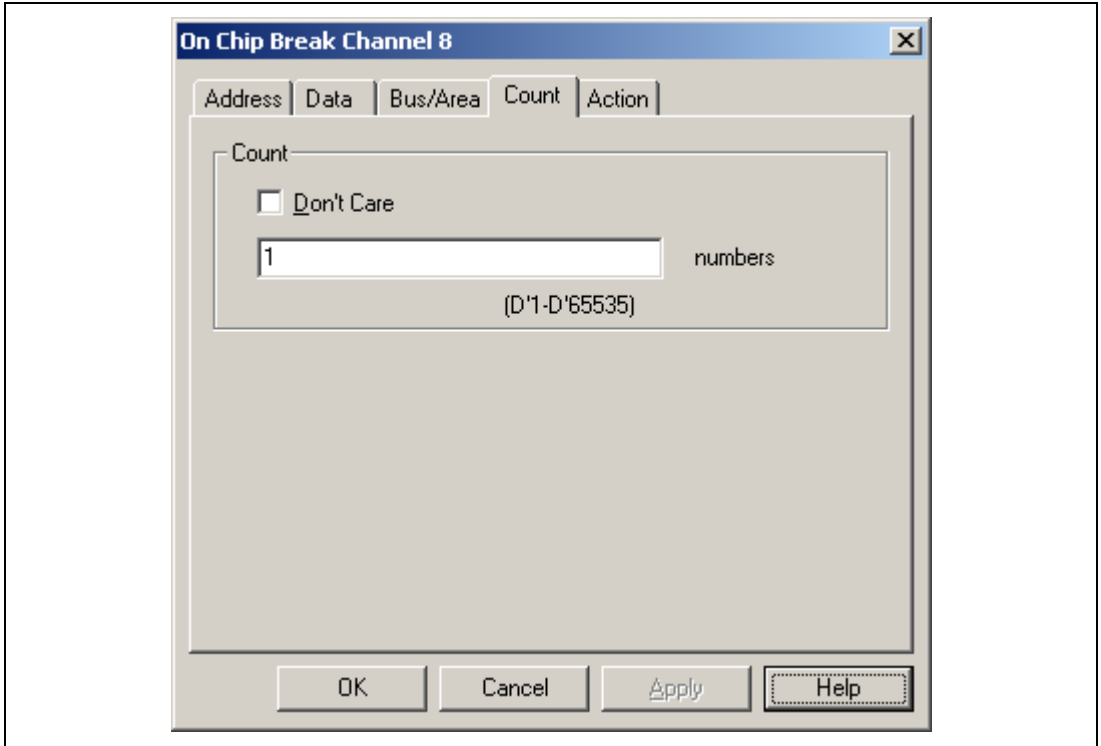

Figure 5.19 [On Chip Break Channel 8] Dialog Box ([Count] Page)

Table 5.16 [Count] Page Options

Option	Description
[Don't Care]	Selects no satisfaction count condition.
Input area	Sets a value for the satisfaction count condition as a numeric. The default is D'1. Any value in the range from D'1 to D'65535 can be set here.

Note: The satisfaction count condition can be set only for channel 8.

(e) [Action] Page

Use this page to specify an operating condition when the setting condition has been satisfied.

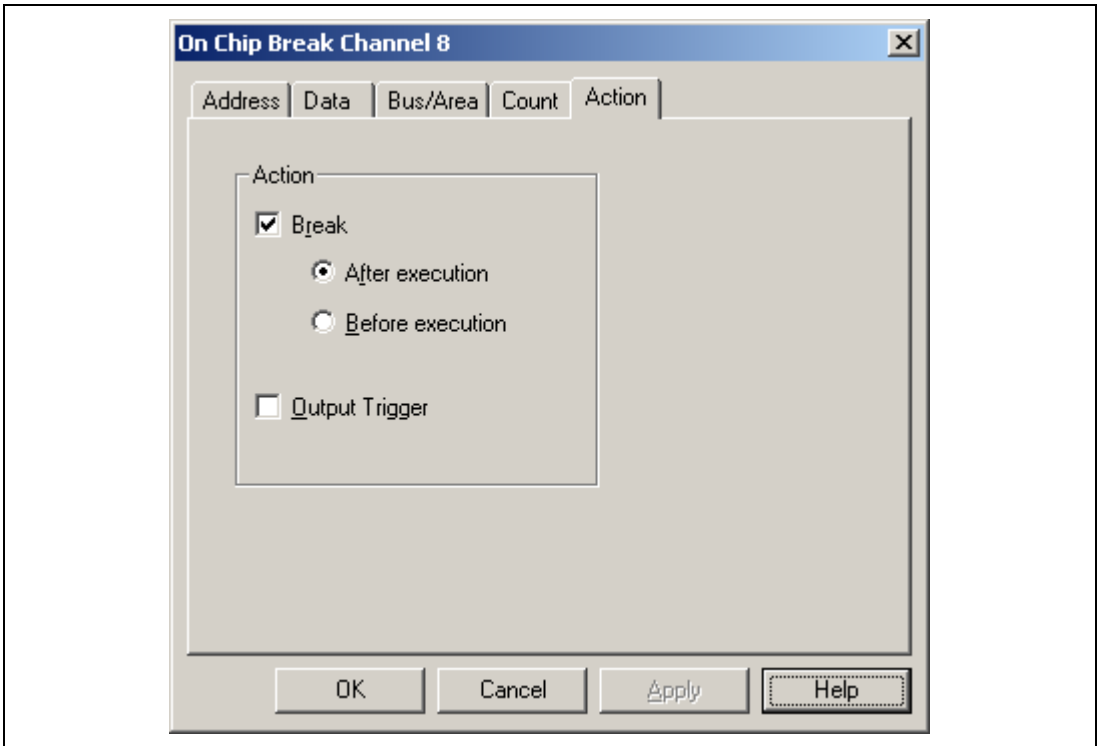

Figure 5.20 [On Chip Break Channel 8] Dialog Box ([Action] Page)

Table 5.17 [Action] Page Options

Option	Description
[Break]	Halts execution when the setting condition has been satisfied. [After execution]: Halts execution after the address at which the condition has been satisfied was executed. [Before execution]: Halts execution before the address at which the condition is satisfied is executed.
[Output Trigger]	Outputs a trigger when the setting condition has been satisfied.

Note: The trigger output when the setting condition has been satisfied can be used only in channels 1 to 8.

(f) [Reset] Page

Use this page to specify the reset point conditions.

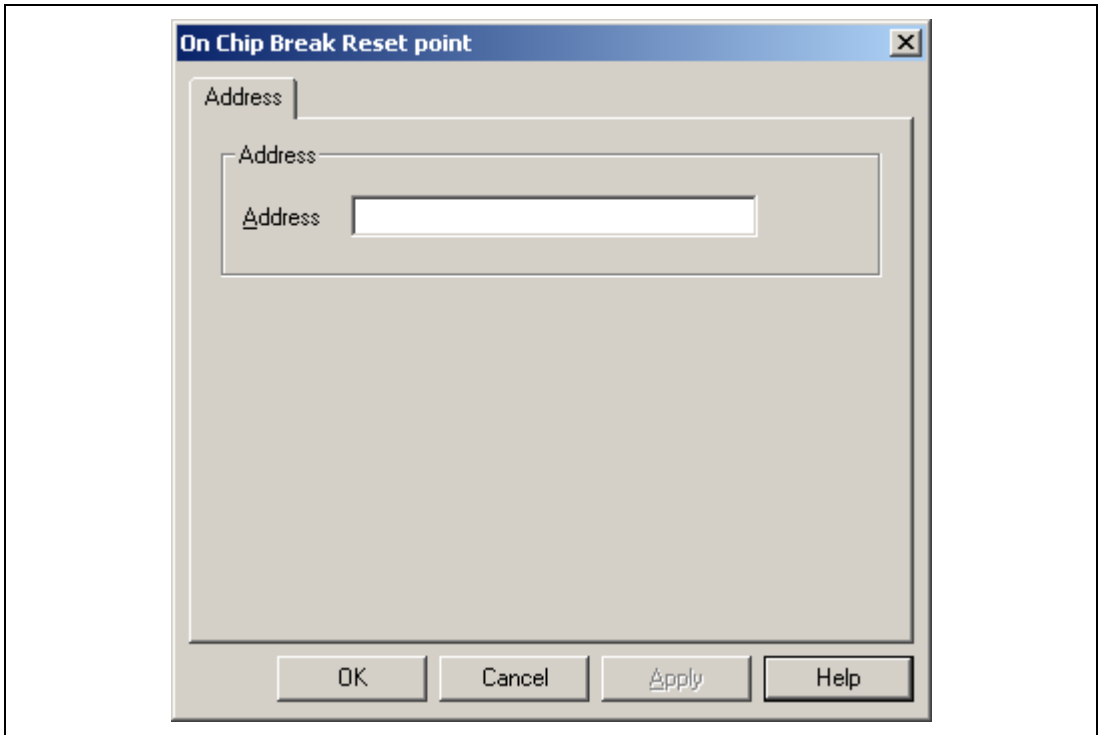

Figure 5.21 [On Chip Break Reset] Dialog Box ([Reset] Page)

Table 5.18 [On Chip Break Reset] Dialog Box Option

Option	Description
[Address]	Specifies the reset point with the address conditions.

5.6.2 On-Chip Sequential Break

Overview: An on-chip sequential break set up with on-chip break occurs when on-chip break conditions are satisfied in one of three specified orders.

As shown in table 5.19, there are two modes for the on-chip sequential break that uses On Chip Break Channel 1 to 8 and Reset. When a reset point condition is satisfied before satisfaction of On Chip Break Channel 8, all the satisfied conditions are cleared. The emulator then restarts checking for satisfaction of the on-chip sequential break conditions from the first condition.

Table 5.19 On-Chip Sequential Break Modes (On Chip Break Channel 1 to 8)

Mode	Description
8-level on-chip sequential break	On Chip Break Channel 1 to 8 are used for sequential break. In this mode, up to eight sequential break conditions can be set. The normal On Chip Break condition can be independently set for On Chip Break Channel 9 to 12.
4-level on-chip sequential break	On Chip Break Channel 1 to 4 are used for sequential break. In this mode, up to four sequential break conditions can be set. The normal On Chip Break condition can be independently set for On Chip Break Channel 1 to 4 and 9 to 12.

Note: When the same sequential break conditions are continued, only the first condition is considered as satisfied. In this case, other conditions are not satisfied and no sequential break occurs.

Setting an On-Chip Sequential Break: Set the on-chip break conditions. To specify the on-chip sequential break mode, which uses On Chip Break Channel 1 to 8, select [Sequential Break] on the [On Chip Break] page of the [Breakpoint Properties] dialog box. In the example shown in figure 5.22, 8-level on-chip sequential break mode is selected.

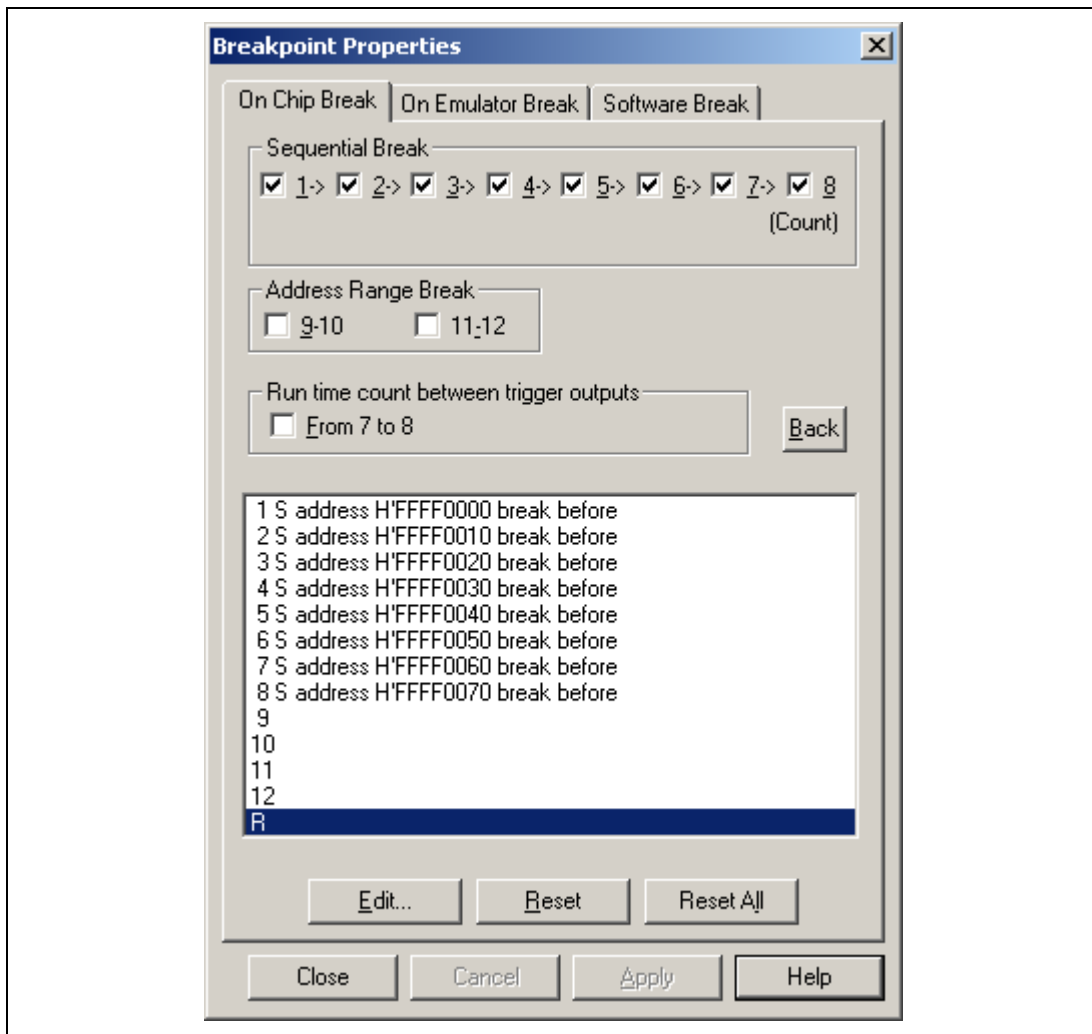

Figure 5.22 [Breakpoint Properties] Dialog Box ([On Chip Break] Page)

Table 5.20 shows the items selected in [Sequential Break] when the on-chip sequential break is specified using On Chip Break Channel 1 to 8.

Table 5.20 [Sequential Break] Options (On Chip Break Channel 1 to 8)

[Sequential Break] Item	Description
8-level on-chip sequential break mode	When either of 1, 2, 3, or 4 is selected, Channels 1 to 8 are always used as a sequential break. Set the different conditions for all of Channels 1 to 8.
4-level on-chip sequential break mode	When either of 5, 6, 7, or 8 is selected, Channels 5 to 8 are always used as a sequential break. Set the different conditions for all of Channels 5 to 8.

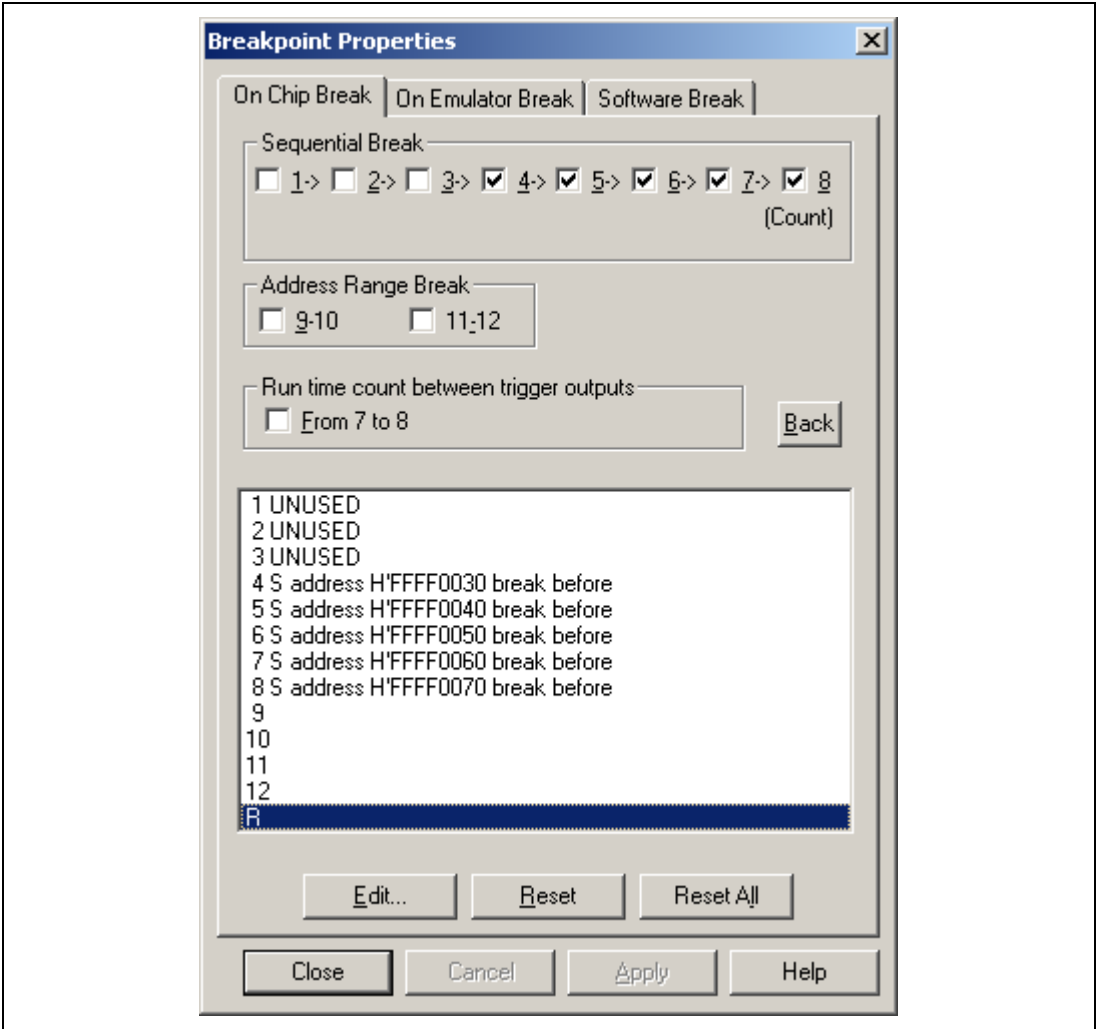

Figure 5.23 Selecting 4 for [Sequential Break]

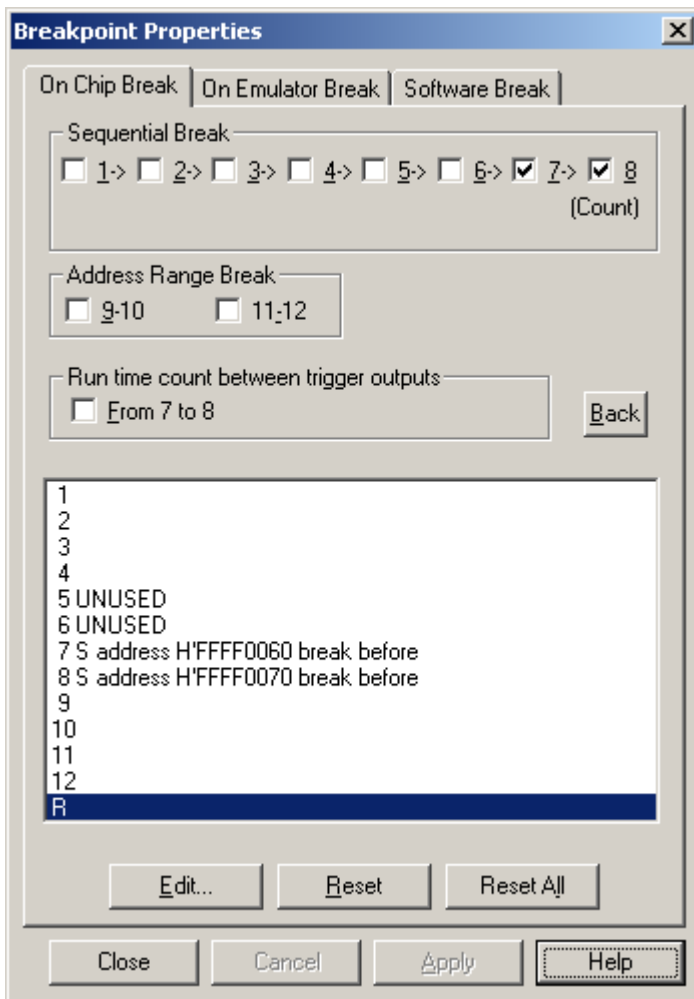

Figure 5.24 Selecting 7 for [Sequential Break]

5.6.3 On-Emulator Break

Overview: On-emulator break functions are implemented by dedicated hardware in the E6000H station. The on-emulator break conditions have four channels (On Emulator Break 1 to 4). On-emulator break occurs when all of the specified conditions (an AND condition) are satisfied.

Table 5.21 On-Emulator Break Conditions

Condition	Description
Address bus	Satisfied when the value on the address bus matches the specified value.
Data bus	Satisfied when the value on the data bus matches the specified value.
Bus/Area	Satisfied when the specified access type, bus status, and read/write cycle conditions are matched. When no condition is set, all bus cycles, including program-fetch cycles, satisfy the condition.
External probe	Satisfied when the external probe (PRB) signal levels match a specification.
External interrupt signal	Satisfied when the external interrupt signal levels match a specification.
Satisfaction count	The break occurs when the above conditions are satisfied the specified number of times.

Setting an On-Emulator Break: The setting of On Emulator Break 1 is taken as an example.

Place the cursor in the [Breakpoints] window then click the right-hand mouse button to display the window's pop-up menu. Select [Edit...] from the menu, and the dialog box will appear (figure 5.15). Click the [On Emulator Break] tab to select the [On Emulator Break] page (figure 5.25).

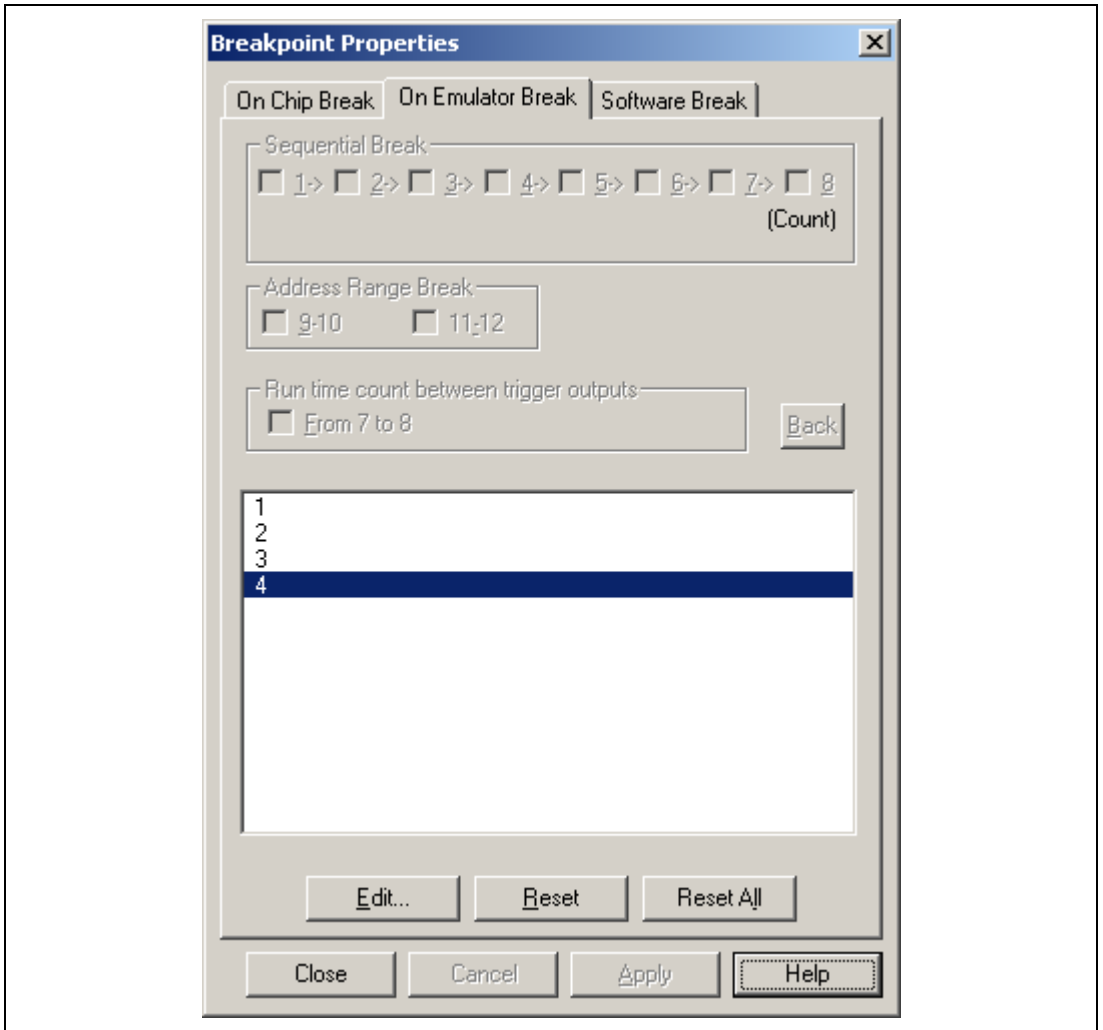

Figure 5.25 [Breakpoint Properties] Dialog Box ([On Emulator Break] Page)

Table 5.22 Options in the [On Emulator Break] Page

Option	Description
[Edit...]	Modifies the settings on On Emulator Break 1 to 4 selected in the list box. Clicking this button opens the [On Emulator Break Channel <i>n</i>] dialog box. (<i>n</i> : 1 to 4)
[Reset]	Clears the settings on On Emulator Break 1 to 4 selected in the list box
[Reset All]	Clears all settings on On Emulator Break 1 to 4 in the list box.

The following sections describe each page.

(a) [Address] Page

Use this page to specify the address bus conditions.

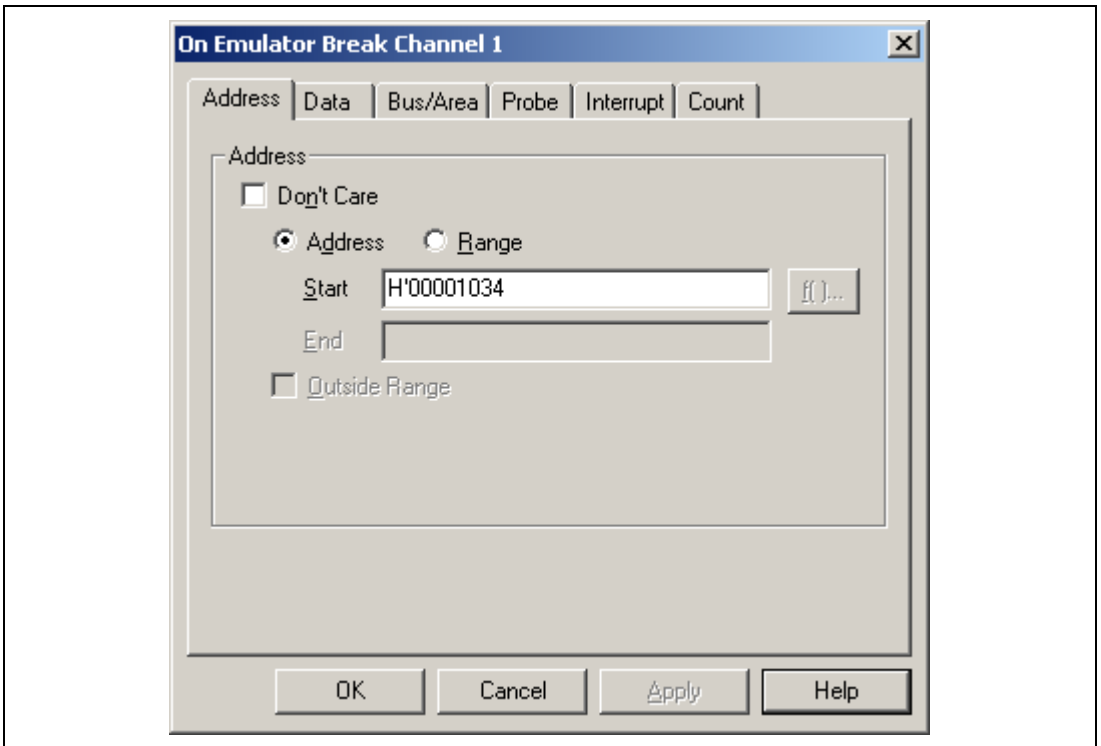

Figure 5.26 [On Emulator Break Channel 1] Dialog Box ([Address] Page)

Table 5.23 [Address] Page Options

Option	Description
[Don't Care]	Selects no address bus condition.
[Address]	Select this button to set the address bus value specified in [Start] as the break condition.
[Range]	A break occurs in the range of the address bus values specified from [Start] to [End]. [Start]: Sets the (start) address bus value as a numeric or a symbol. [End]: Sets the (end) address bus value as a numeric or a symbol.
[Outside Range]	Selects this option to generate a break with the value set in [Start] or an address bus outside the range set from [Start] to [End].

- Notes:
1. Set a multiple of two as the address value when the 16-bit area is accessed.
 2. Set a multiple of four as the address value when the 32-bit area is accessed.

(b) [Data] Page

Use this page to specify the data bus conditions. The data bus condition must be set considering the address bus, data bus width, and access size.

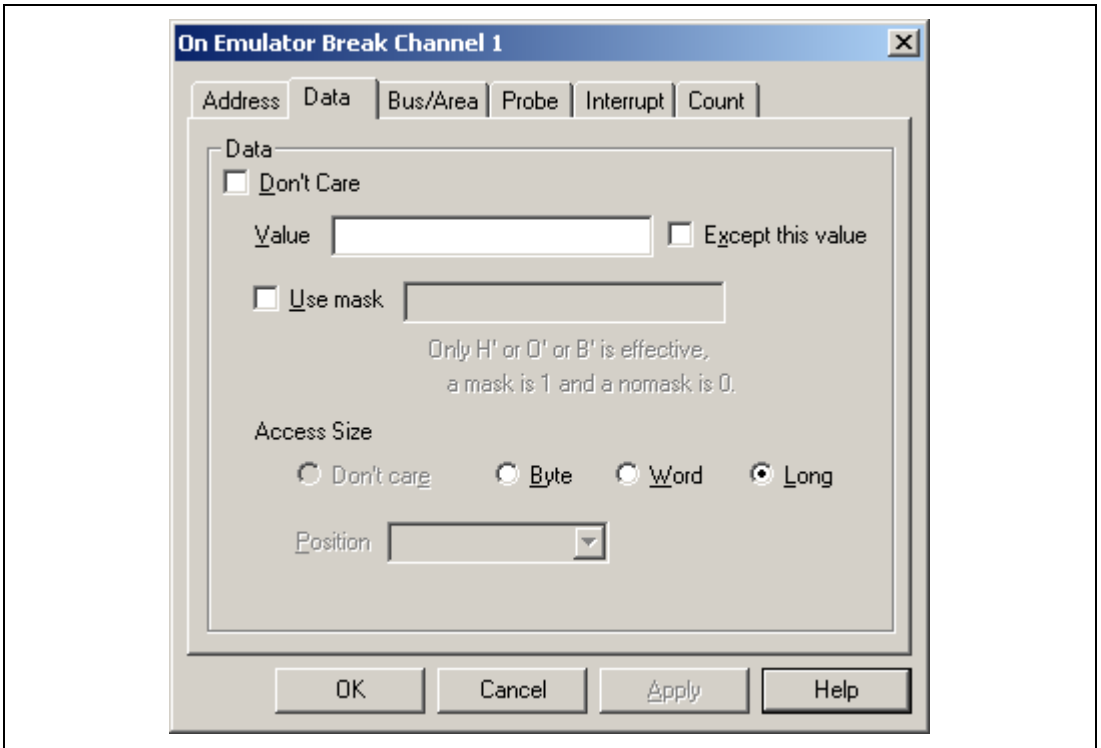

Figure 5.27 [On Emulator Break Channel 1] Dialog Box ([Data] Page)

Table 5.24 [Data] Page Options

Option	Description
[Don't Care]	Sets no data bus condition.
[Value]	Sets a data bus value as a number.
[Access Size]	<p>Specifies the data-access size.</p> <p>[Byte]: Sets byte-data-access cycles.</p> <p>[Word]: Sets word-data-access cycles.</p> <p>[Long]: Sets longword-data-access cycles.</p> <p>[Position]: Sets a data bus value as a number. The position of the valid data bus is specified.</p> <p style="padding-left: 40px;">[Long]: None</p> <p style="padding-left: 40px;">[Word]: 4n: Upper word 4n + 2: Lower word</p> <p style="padding-left: 40px;">[Byte]: 4n: Upper byte of the upper word 4n + 1: Lower byte of the upper word 4n + 2: Upper byte of the lower word 4n + 3: Lower byte of the lower word</p>
[Except this value]	Sets a value other than that has been specified as the data bus condition.
[Use mask]	Sets mask conditions. Sets the mask bits if [User mask] is selected. Masked bits on the data bus satisfy this break condition regardless of their values.

(c) [Bus/Area] Page

Use this page to specify conditions for the read or write cycle and access type.

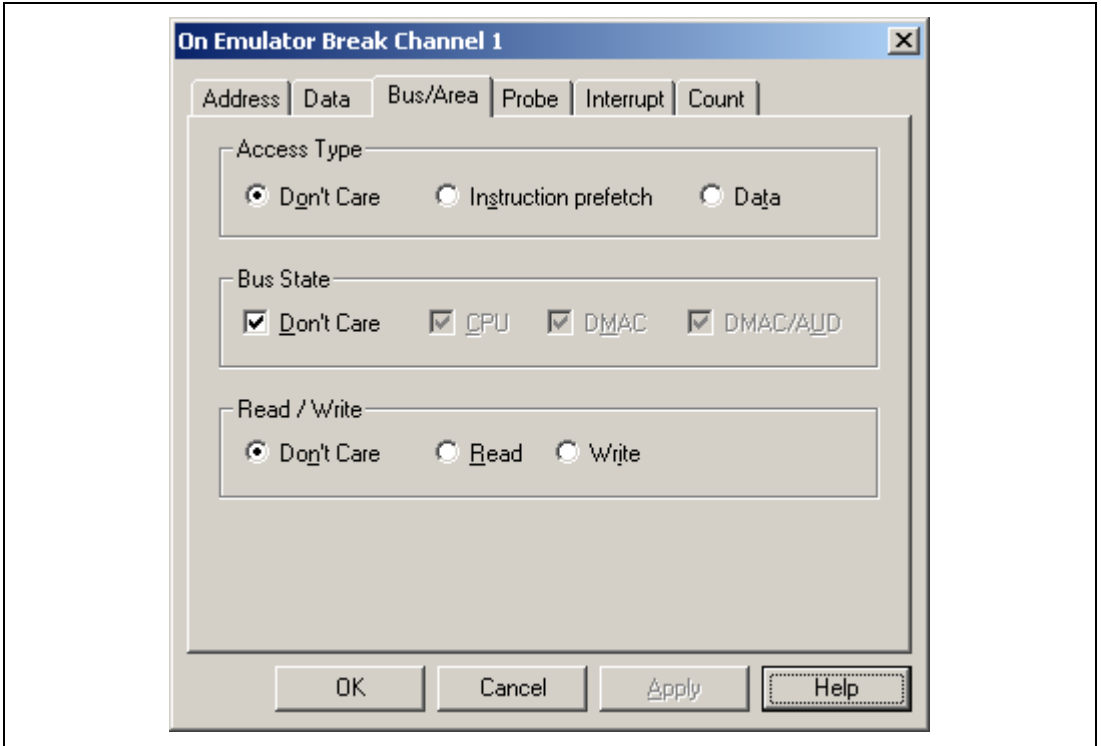

Figure 5.28 [On Emulator Break Channel 1] Dialog Box ([Bus/Area] Page)

Table 5.25 [Bus/Area] Page Options

[Access Type] Group Box

Option	Description
[Don't Care]	All access types satisfy this condition.
[Instruction prefetch]	Instruction prefetch cycles satisfy this condition.
[Data]	Data access cycles satisfy this condition.

[Bus State] Group Box

Option	Description
[Don't Care]	All cycles satisfy this condition.
[CPU]	CPU cycles satisfy this condition.
[DMAC/AUD]	DMAC and AUD cycles satisfy this condition.

[Read/Write] Group Box

Option	Description
[Don't Care]	Both of read and write cycles satisfy this condition.
[Read]	Read cycles satisfy this condition.
[Write]	Write cycles satisfy this condition.

(d) [Probe] Page

Use this page to specify external probe signal (PRB1 to PRB4) conditions.

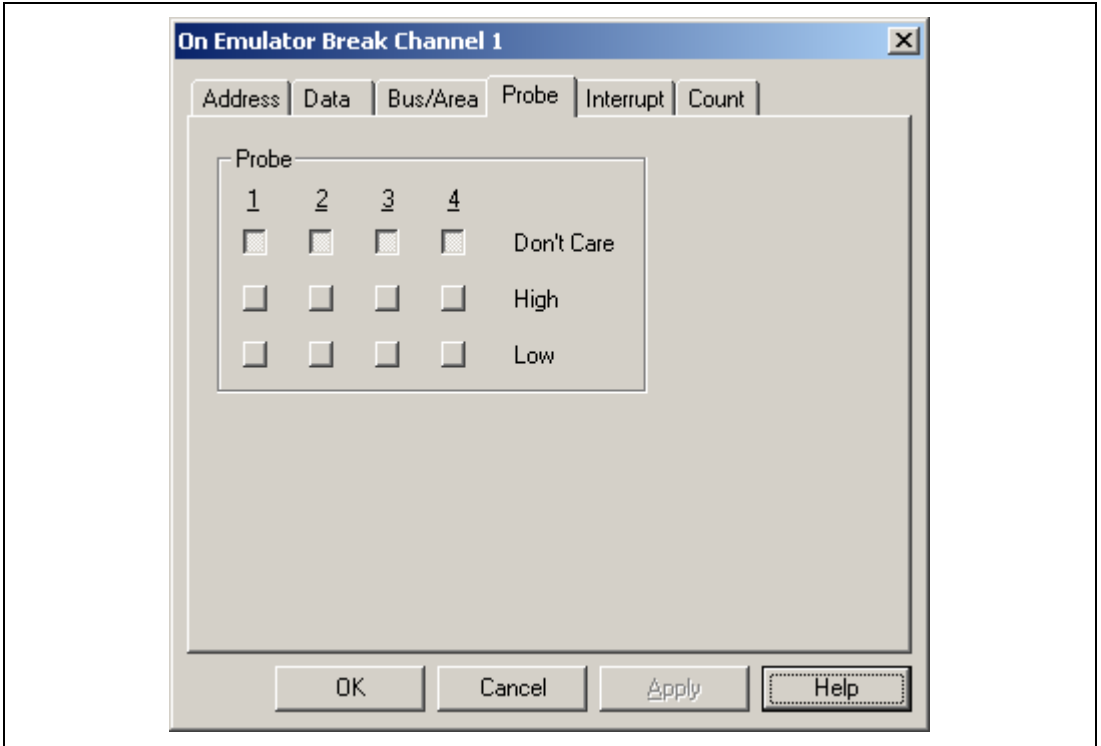

Figure 5.29 [On Emulator Break Channel 1] Dialog Box ([Probe] Page)

Table 5.26 [Probe] Page Options

Option	Description
[Don't Care]	Selects no external probe signal state condition.
[High]	Sets the high level of this external probe signal as a break condition.
[Low]	Sets the low level of this external probe signal as a break condition.

Use this page to specify external interrupt (IRQ0 to IRQ7) and NMI signal conditions.

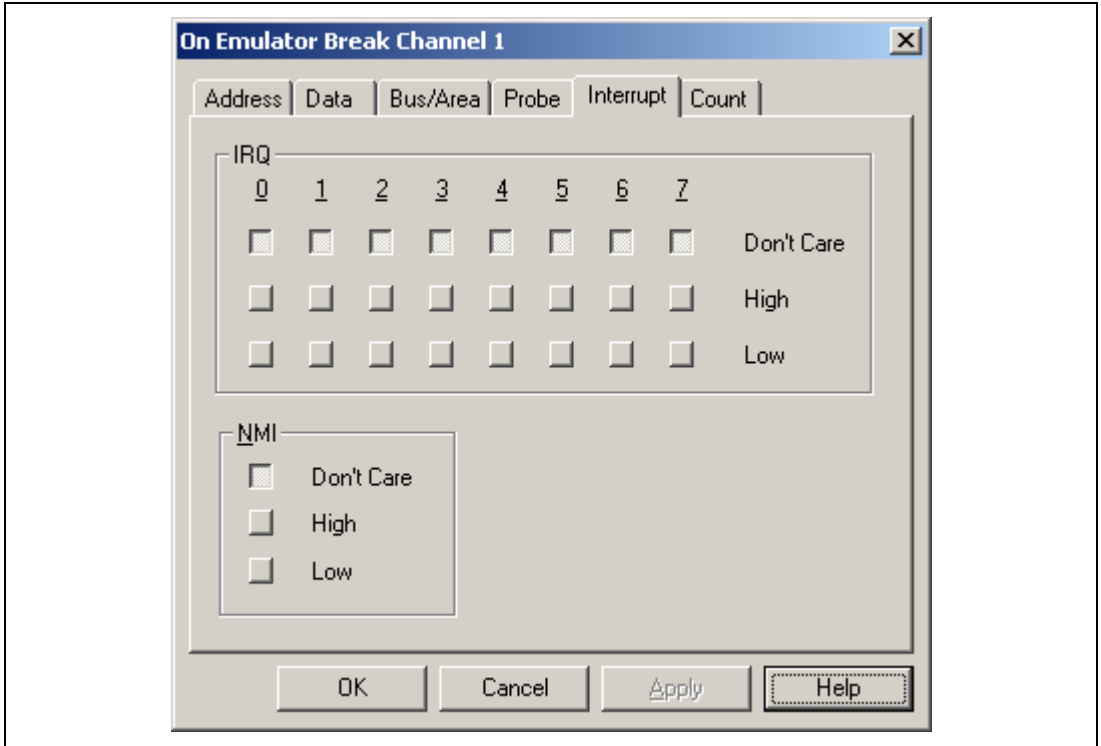

Figure 5.30 [On Emulator Break Channel 1] Dialog Box ([Interrupt] Page)

Table 5.27 [Interrupt] Page Options

[IRQ0 to IRQ7] Group Box

Option	Description
[Don't Care]	Selects no external interrupt signal state condition.
[High]	Sets the high level of this external interrupt signal as a break condition.
[Low]	Sets the low level of this external interrupt signal as a break condition.

[NMI] Group Box

Option	Description
[Don't Care]	Selects no NMI signal-state condition.
[High]	Sets the high level of the NMI signal as a break condition.
[Low]	Sets the low level of the NMI signal as a break condition.

(f) [Count] Page

Use this page to specify a satisfaction count condition.

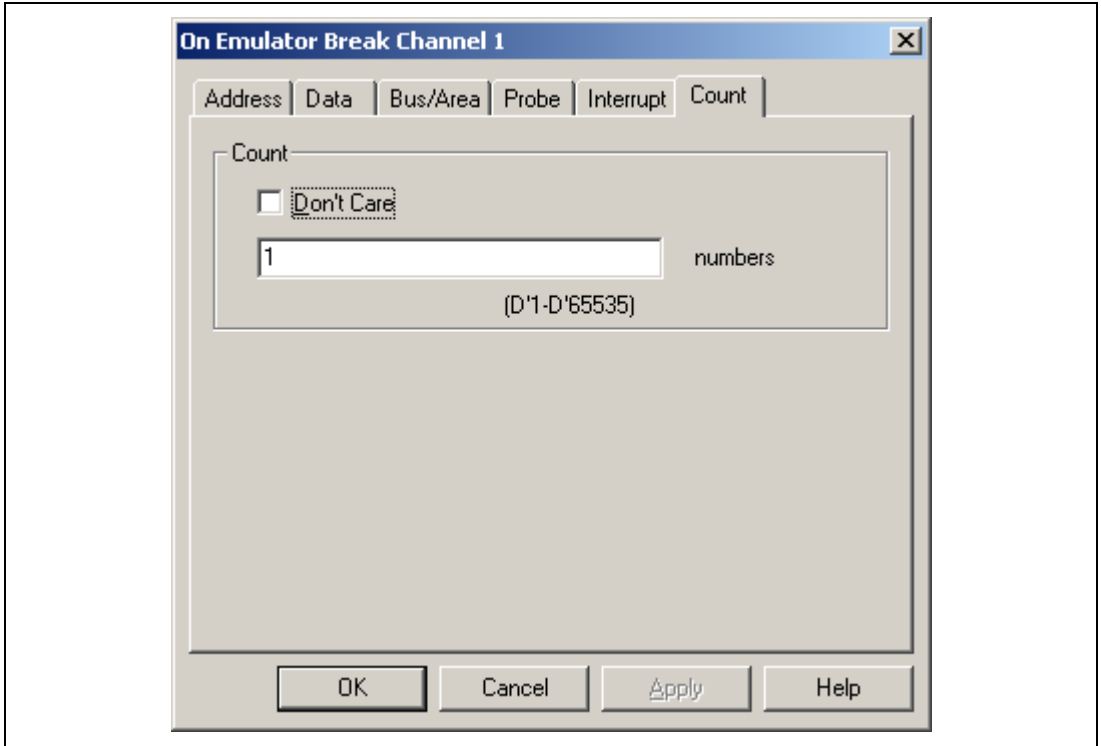

Figure 5.31 [On Emulator Break Channel 1] Dialog Box ([Count] Page)

Table 5.28 [Count] Page Options

Option	Description
[Don't Care]	Selects no satisfaction count condition.
Input area	Sets a value for the satisfaction count condition as a numeric. The default is D'1. Any value in the range from D'1 to D'65535 can be set here.

5.6.4 Software Break

Overview: Any content at the specified address is replaced by a break instruction (a dedicated instruction for use with the emulator). Execution of the user program stops when the break instruction is executed. The instruction that had been at the address is not executed, so the result is a break before execution.

It is possible to specify up to 255 software breakpoints.

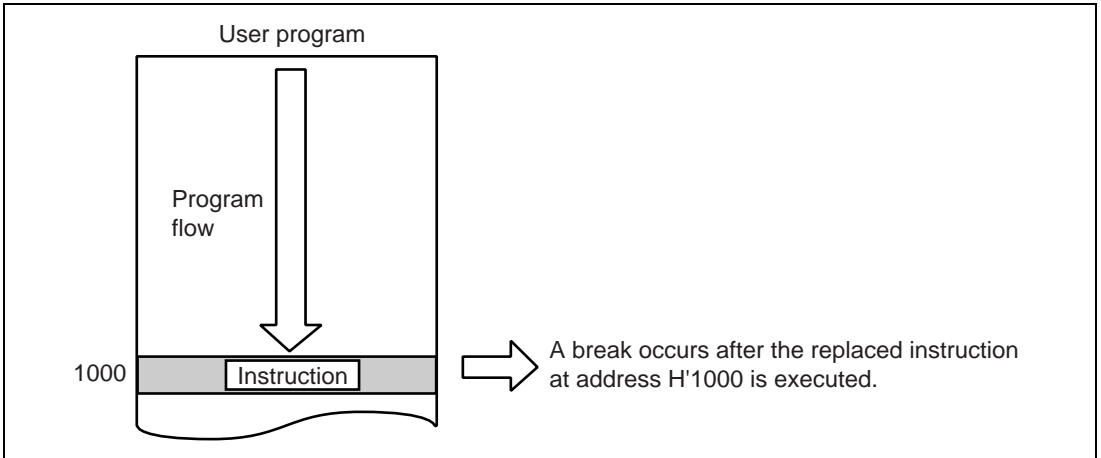

Figure 5.32 Example of a Software Break Instruction

The software break cannot be set in the on-chip ROM area (on-chip flash memory area). To set the software break in the on-chip ROM area, use the ERAM and emulate the ROM area.

Setting a Software Break: Place the cursor in the [Breakpoints] window and click the right-hand mouse button to display the pop-up menu. Select [Add...] from the menu, and the [Breakpoint Properties] dialog box (figure 5.15) will appear. Click the [Software Break] tab and select the [Software Break] page (figure 5.33).

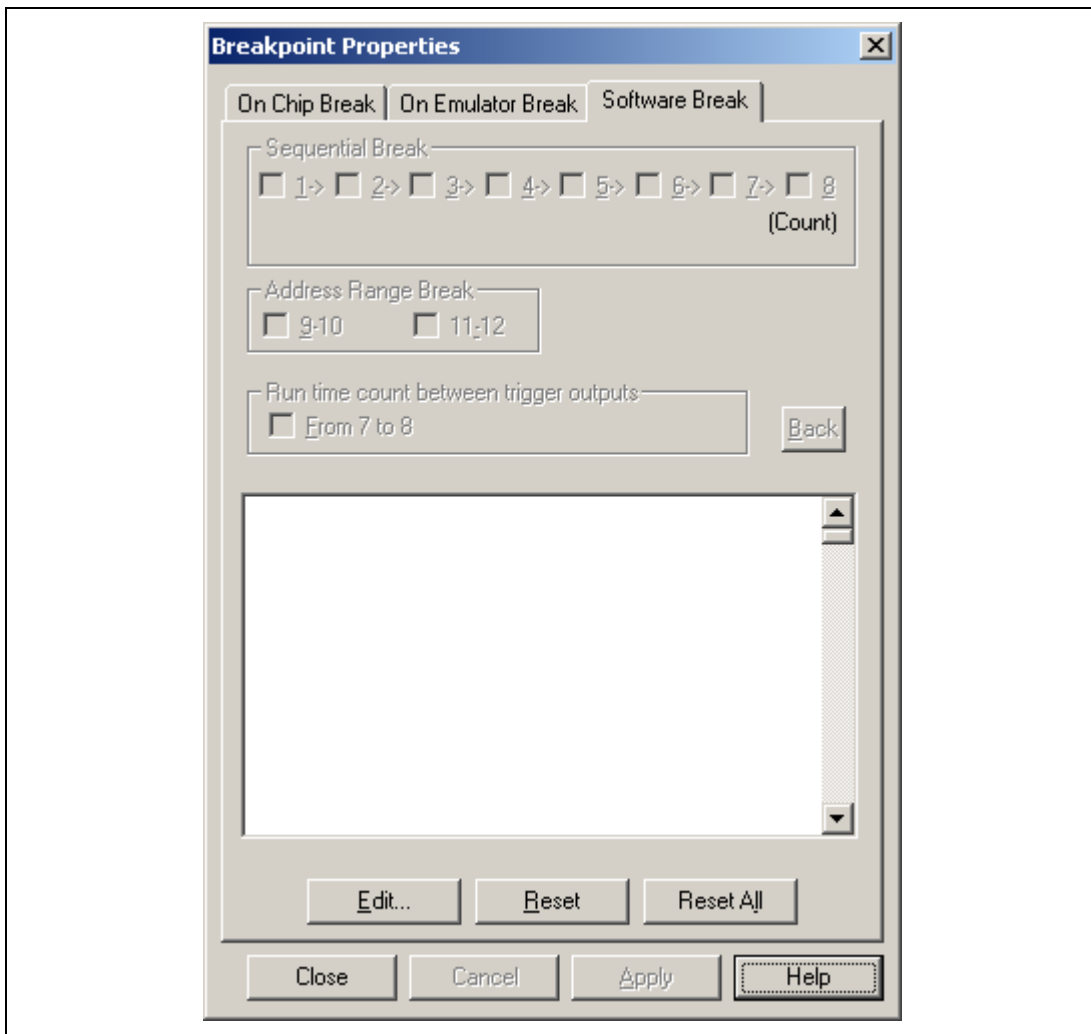

Figure 5.33 [Breakpoint Properties] Dialog Box ([Software Break] Page)

Table 5.29 [Software Break] Page Options

Option	Description
[Edit...]	Allows the user to modify the software breakpoint settings. Clicking the [Edit...] button by selecting the list box displays the [Address] dialog box.
[Reset]	Clears the software breakpoint settings selected in the list box.
[Reset All]	Clears all software breakpoints.

Clicking the [Edit...] button by selecting the list box in the [Software Break] page displays the [Software Break] dialog box. For the software break, only the [Address] page is displayed. Specify the breakpoint's address, then click the [OK] button.

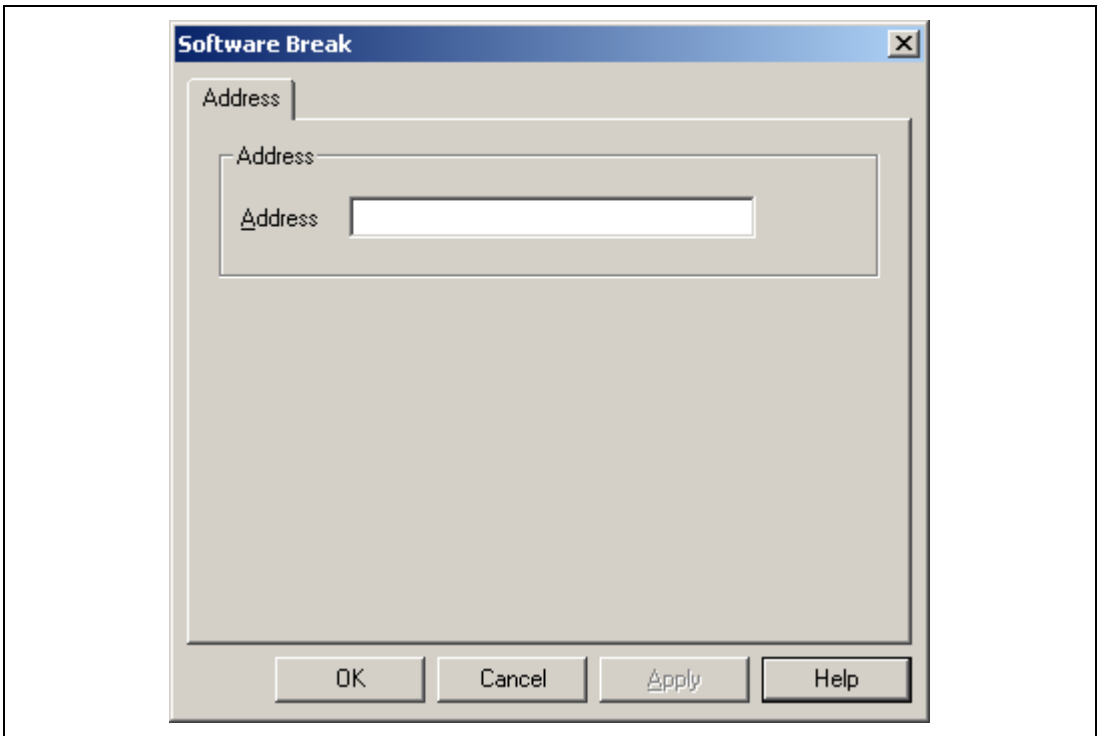

Figure 5.34 [Software Break] Dialog Box ([Address] Page)

The display returns to the [Software Break] page. The list box now displays the specified address. Click the [OK] button to close the [Breakpoint Properties] dialog box.

Table 5.30 [Software Break] Dialog Box Option

Option	Description
[Address]	Sets the breakpoint's value as a numeric.

When a software break is set, the instruction at the specified address is replaced. It is only possible to set a software break in the RAM area (including the emulation memory). However, it is not possible to set a software breakpoint at an address that satisfies any of these conditions:

- The address holds H'0000
- The address is in any area other than CS area (except the on-chip ROM/RAM area)
- The address of the delay slot for a delayed-branch instruction

- Notes:
1. The maximum number of software breakpoints and [Stop At] settings allowed in the [Run Program] dialog box is 255. Therefore, when 255 software breakpoints have been set, any further specification made by using the [Stop At] item in the [Run Program] dialog box is invalid. Ensure that the total number of software breakpoints and settings made by using the [Stop At] item in the [Run Program] dialog box is 255 or less.
 2. When a disabled breakpoint address is specified as a [Stop At] item in the [Run Program] dialog box, the breakpoint becomes enabled after the first time that execution subsequently stops at that address.
 3. If it is not possible to correctly set a breakpoint when a session file is loaded, the breakpoint is registered as DISABLE in the [Breakpoints] window.
 4. Software breakpoints are ignored during step execution.
 5. Do not set a break immediately after the delayed branch instruction (slot instruction). If this is attempted, a slot illegal instruction interrupt will occur when the delayed branch instruction is executed, and the break will not occur.
 6. Do not allow the user program to modify memory at a breakpoint address.
 7. The contents of the specified address where a breakpoint has been set are replaced by a break instruction during emulation.

5.6.5 Forced Break

A user program can be forcibly terminated by clicking the [STOP] button or by selecting [Halt] from the [Run] menu.

5.6.6 Break Due to Trace-Buffer Overflow

A break occurs when the trace buffer in the E6000H station overflows during trace acquisition.

Select [Stop execution and stop trace] in [When trace-buffer full] on the [Other] page of the [Trace Acquisition Properties] dialog box.

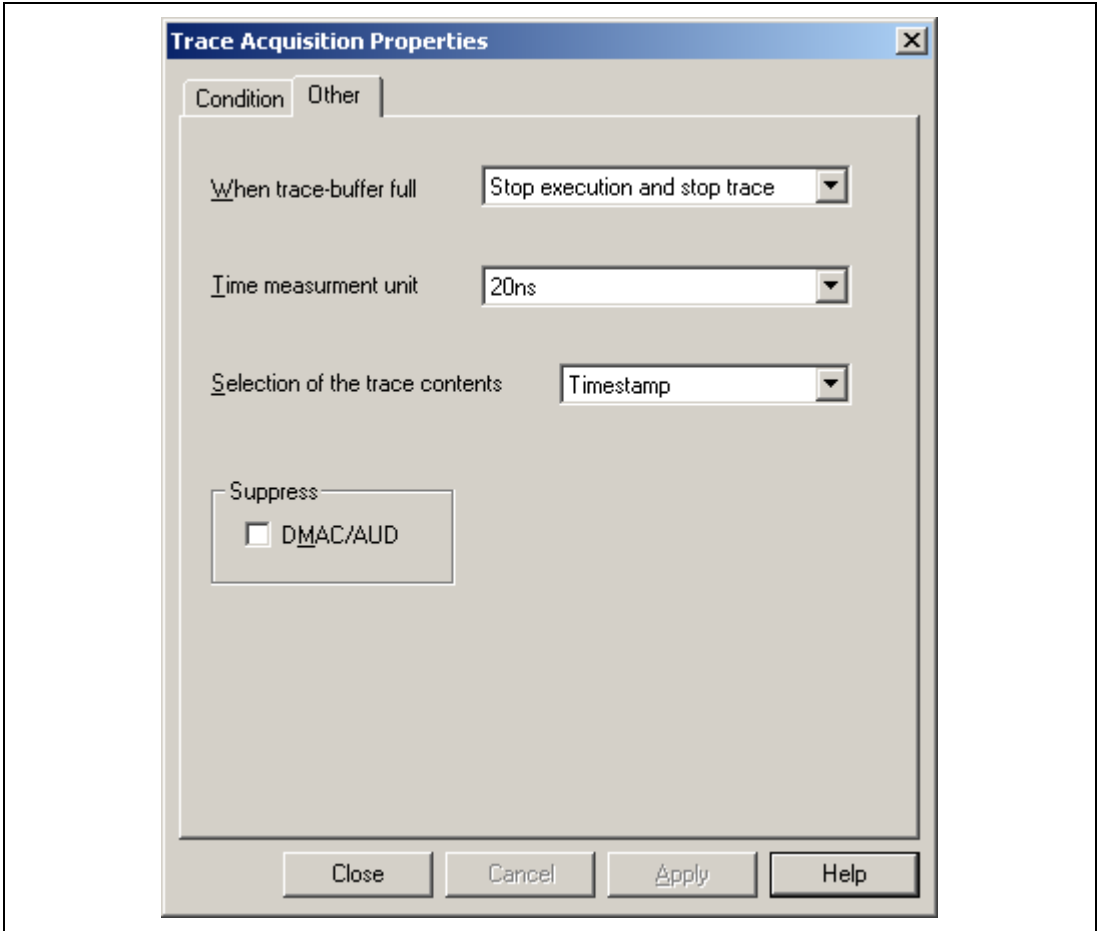

Figure 5.35 [Trace Acquisition Properties] Dialog Box ([Other] Page)

5.7 Realtime Trace Functions

The emulator allows realtime trace acquisition of up to 131,070 cycles of the SH7058 bus information. This has no effect on the user system during emulation.

A total of up to 65,535 lines of information can be displayed in the HDI's [Trace] window. For details on the [Trace] window, refer to the Hitachi Debugging Interface User's Manual (on the CD-R).

5.7.1 Trace Acquisition Condition

Trace Conditions 1 to 12 are available.

Specify a trace acquisition condition on each page of the [Trace Acquisition Properties] dialog box which will be displayed by clicking [Acquisition...] in the pop-up menu of the [Trace] window and the [Action] page in the [Trace Acquisition Condition Channel n] (n : integers 1 to 12).

The trace acquisition modes are shown in table 5.31.

Table 5.31 Trace Acquisition Modes

Acquisition Mode	Description
Free trace	Trace acquisition is continuous; from the start of user-program execution until any of the break conditions is satisfied.
Sequential trace stop	An order in which trace conditions must be satisfied can be specified. When all of the conditions are satisfied in the specified order, trace acquisition will stop. Can be specified for Trace Conditions.*
Trace stop due to an overflow of trace buffer	Trace acquisition stops when the trace buffer in the emulator overflows.*
Trace stop	Trace acquisition stops when a specified condition is satisfied. In this mode, trace acquisition is stopped without halting user program execution.*
Address range trace	Instruction and operand accesses are traced during execution in the range between the start address and end address of a specified subroutine, or of a subroutine specified by its start and end addresses. However, when the specified subroutine calls other subroutines, the called subroutine will not be traced.
Conditional address range trace	In this mode, trace information is only gathered when access is to instructions and operands in the range specified by the start address and end address, during those bus cycles in which the specified conditions are matched.
Conditional trace	Trace is acquired only in the position where the specified conditions are satisfied.
Trigger output	A pulse is output from the trigger pin when the specified conditions are satisfied.

Note: It takes 10 to 11 cycles from the satisfaction of conditions to the halt of trace acquisition.

Free Trace Mode: Trace information is acquired continuously from the start of user program execution until any of the break conditions is satisfied. The free trace mode is the default when [Free trace] in the [Trace Acquisition Properties] dialog box is selected regardless of the settings of other conditions.

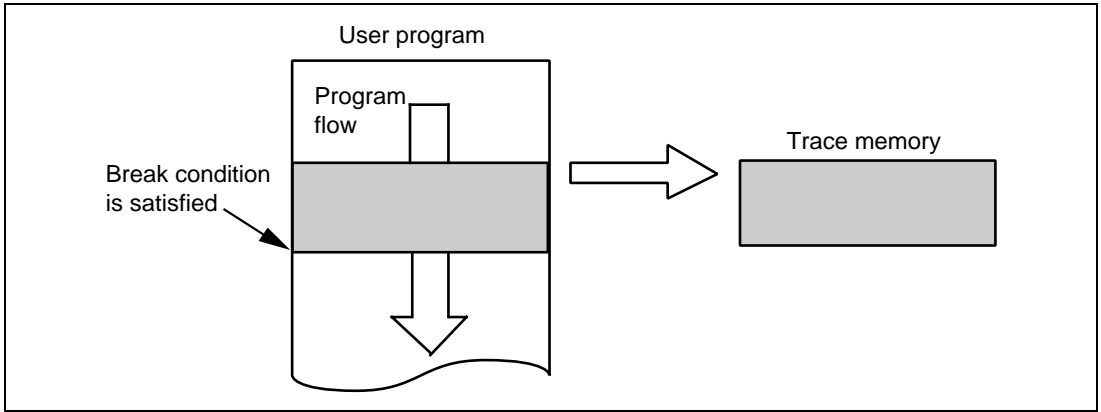

Figure 5.36 Trace Acquisition in Free Trace Mode

Trace-Stop Mode:

(a) Overview

Trace acquisition stops when the specified conditions are satisfied.

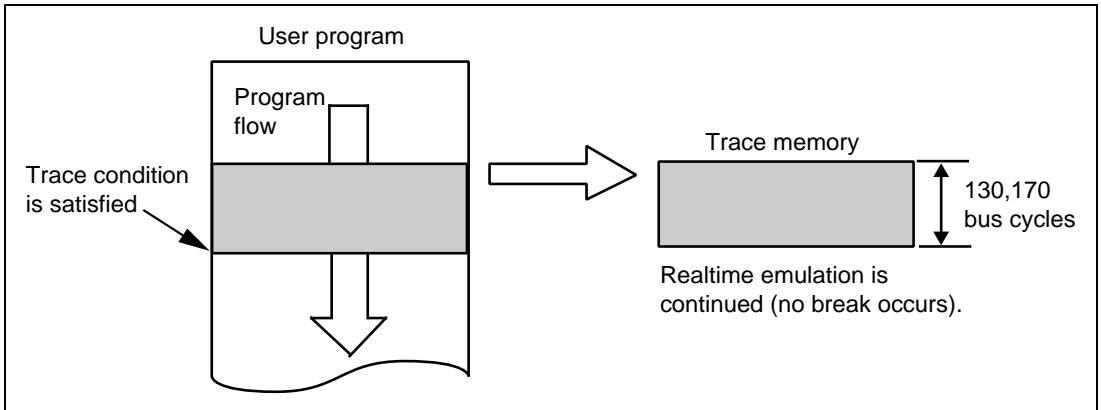

Figure 5.37 Trace Acquisition in Trace-Stop Mode

In this mode, execution of the user program will not be suspended but the emulator enters the trace-halt mode.

The trace stop conditions are shown in table 5.32. When all of the specified conditions (an AND condition) are satisfied, trace acquisition will stop.

Table 5.32 Trace Stop Conditions

Condition	Description
Address bus	The condition is satisfied when the value on the address bus matches the specified value.
Data bus	The condition is satisfied when the value on the data bus matches the specified value.
Bus	The condition is satisfied when the specified access type and read/write cycle conditions match the specification.
External probe signal	The condition is satisfied when the external probe (PRB) signal levels match a specification.
External interrupt signal	The condition is satisfied when the external interrupt signal levels match a specification.
Satisfaction count	Trace acquisition stops when the above conditions are satisfied the specified number of times.
Delay	Trace acquisition stops the specified number of bus cycles after the above conditions have been satisfied. This condition can be set only for Trace Condition 7 and 11.

(b) Setting Trace-Stop Mode Conditions

Trace Condition 7 is taken as an example of setting a trace-stop mode condition.

Place the cursor in the [Trace] window then click the right-hand mouse button to display the pop-up menu. Select [Acquisition] from the menu, and the [Trace Acquisition Properties] dialog box will appear. Select channel 7 from the list box.

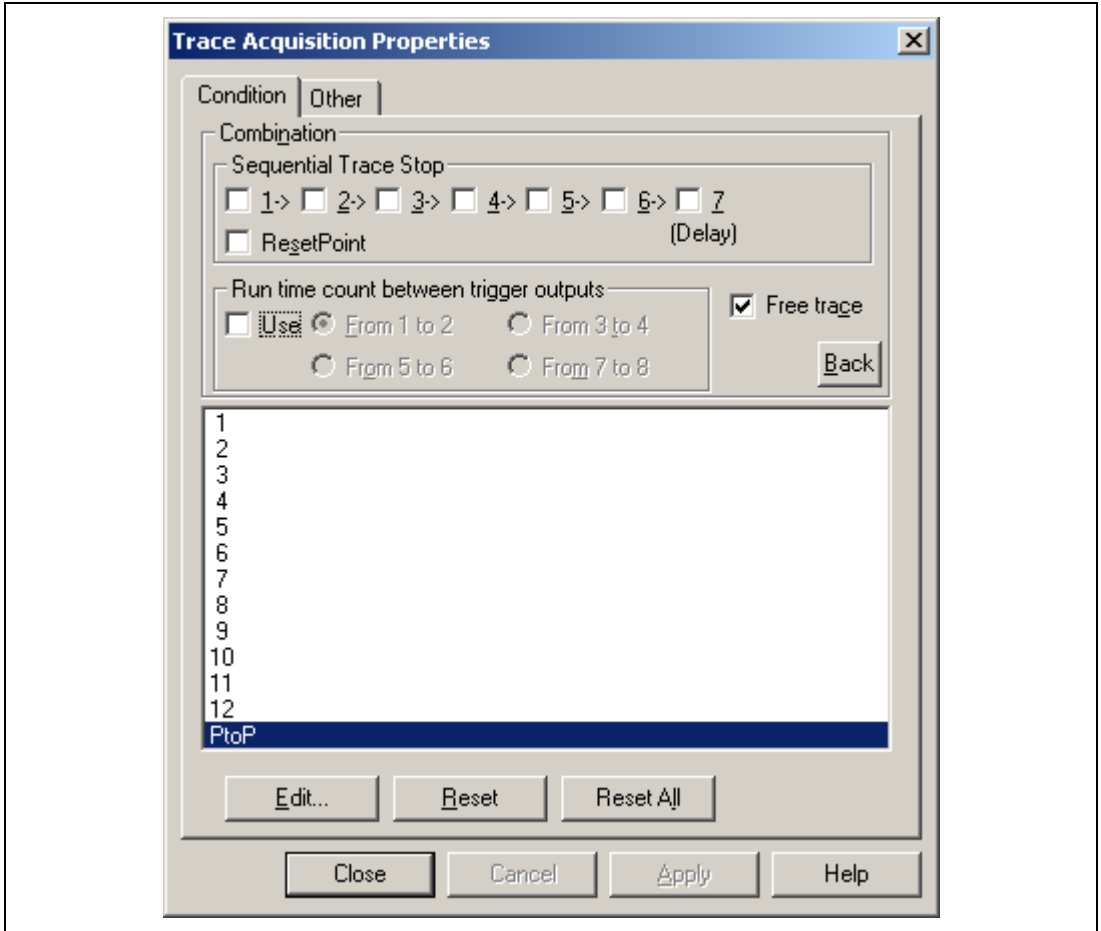

Figure 5.38 [Trace Acquisition Properties] Dialog Box

Table 5.33 shows the [Trace Acquisition Properties] options.

Table 5.33 [Trace Acquisition Properties] Dialog Box Options

Option	Description
[Sequential Trace Stop]	Specifies channels (1 to 7) sequentially and the order of halting trace. A reset point is specified for ResetPoint. The trace is stopped at reset.
[Time measurement between trigger outputs]	Specifies channels that measure the trace time. The time is measured by clicking Use. Channels are used in combination of starting measurement and ending measurement; i.e. 1-2, 3-4, 5-6, and 7-8.
[Free Trace]	Selects free trace.
[Back]	Puts the contents set in the Combination group back when the dialog box has been displayed.
List box	Displays the setting status of Trace Condition. The contents of conditions that are currently set are displayed. Channels 1 to 12 and PtoP (Point to Point measurement) setting channel.
[Edit...]	Modifies the Trace Condition settings selected in the list box. Clicking this button opens the [Trace Condition X] dialog box. (X: 1, 2, ..., 11, 12.)
[Reset]	Clears the Trace Condition settings selected in the [Condition] list box.
[Reset All]	Clears all Trace Condition settings.

- Notes:
1. When a combination of 1-2, 3-4, or 5-6 is selected for [Time measurement between trigger outputs], the period from starting measurement to ending measurement must be set with an interval of six or more bus cycles.
 2. When a combination of 7-8 is selected for [Time measurement between trigger outputs], the period from starting measurement to ending measurement must be set with an interval of 15 or more bus cycles.

Double-click 7 in the list box on the [Condition] page by using a mouse. Click the [Edit...] button to open the [Trace Acquisition Condition Channel 7] dialog box. The trace acquisition mode is specified on the [Action] page.

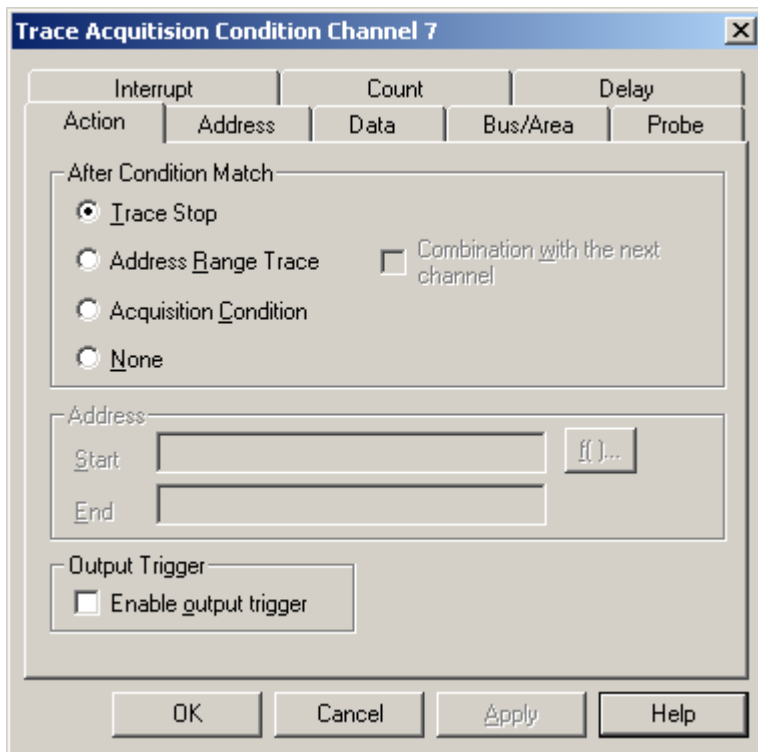

Figure 5.39 [Action] Page

Table 5.34 [Action] Page Options

Option	Description
[After Condition Match]	Specifies the processing after the trace condition has been satisfied. Select the following items.
[Trace Stop]	Sets the trace halt mode. Halting trace is selected after the trace condition has been satisfied.
[Address Range Trace]	Sets the address range trace mode. The trace is acquired by specifying the address range. Combination with the next channel (selected for channels 1, 3, 5, and 7) Uses the next channel to additionally set other acquisition conditions in the range trace and sets the conditional address range trace mode.
[Acquisition Condition]	Sets the conditional trace mode.
[None]	Selects this option when the starting measurement and ending measurement conditions of [Time measurement between trigger outputs] are set, which does not affect the acquired trace.
[Address]	Sets the address range when Address Range Trace is selected.
[Output Trigger]	Outputs a trigger externally after the trace condition has been satisfied.

Table 5.35 shows the dialog box options for each channel.

Table 5.35 [Trace Acquisition Condition Channel] Dialog Box Pages

Dialog Box	Page	Description
Channels 1, 2, 3, 4, 5, 6, 8, 9, 10, and 12	[Action]	Selects the processing after the trace condition has been satisfied.
	[Address]	Sets address bus conditions.
	[Data]	Sets data bus conditions.
	[Bus/Area]	Sets access type and read/write cycle conditions.
	[Probe]	Sets external probe signal conditions.
	[Interrupt]	Sets external interrupt signal conditions.
	[Count]	Sets satisfaction count conditions.
Channels 7 and 11	[Action]	Selects the processing after the trace condition has been satisfied.
	[Address]	Sets address bus conditions.
	[Data]	Sets data bus conditions.
	[Bus/Area]	Sets access type and read/write cycle conditions.
	[Probe]	Sets external probe signal conditions.
	[Interrupt]	Sets external interrupt signal conditions.
	[Count]	Sets satisfaction count conditions.
	[Delay]	Sets delay conditions.

Specify the required conditions on the corresponding pages, then click the [OK] button.

The options on each page are the same as those of the on-emulator break, except the [Action] and [Delay] pages. For details of the options on each page, refer to section 5.6.3, On-Emulator Break. Figure 5.40 shows the setting of the [Delay] page and table 5.36 shows the options.

- Notes:
1. Set a multiple of two as the address value when the 16-bit area is accessed.
 2. Set a multiple of four as the address value when the 32-bit area is accessed.
 3. The trace-stop mode condition must be set with an interval of six or more bus cycles.

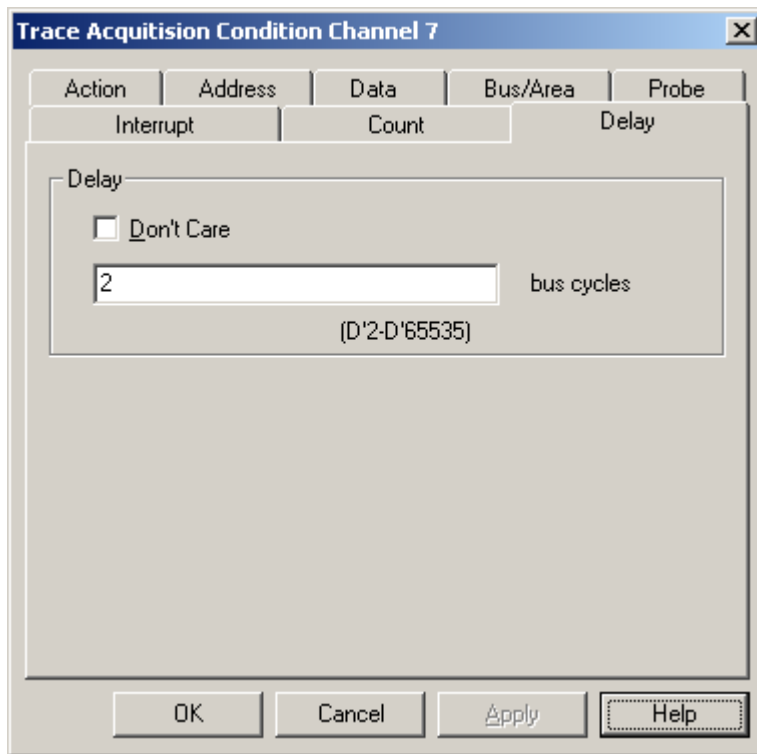

Figure 5.40 [Delay] Page

Table 5.36 [Delay] Page Options

Option	Description
[Don't Care]	Specifies no satisfaction count conditions.
Input area	Sets a value for the satisfaction count condition as a numeric. The default is D'1. Values D'2 to D'65535 can be set.

The [Trace Acquisition Condition Channel 7] dialog box closes and the display returns to the [Condition] page. The specified trace-stop conditions will now be displayed as condition 7 in the list box. Click the [Close] button to close the [Trace Acquisition Properties] dialog box.

Trace stop conditions for the other channels are specified in the same way.

Note: It takes 10 to 11 cycles while the delay condition has been satisfied until the trace acquisition is stopped. Set the delay condition considering the cycle before the trace acquisition is stopped.

Sequential Trace Stop:

(a) Overview

A sequential trace stop occurs after a set of channels of a trace-stop condition has been satisfied in a specified order.

This function uses the trace condition; a sequence of up to seven trace-stop conditions and one reset point can be specified as the trace condition.

The user must consider the order of satisfaction in specifying trace-stop conditions for the trace condition; tracing only stops when the trace-stop conditions have all been satisfied in the order specified by the user.

When the reset point is passed, the record of sequential trace-stop conditions that have been satisfied to that point is cleared, and the emulator restarts checking for satisfaction of the sequential trace-stop conditions from the first condition.

(b) Setting a Sequential Trace Stop

The 5-level sequential trace is taken as an example of using the sequential trace stop.

Place the cursor in the [Trace] window then click the right-hand mouse button to display the pop-up menu. Select [Acquisition].

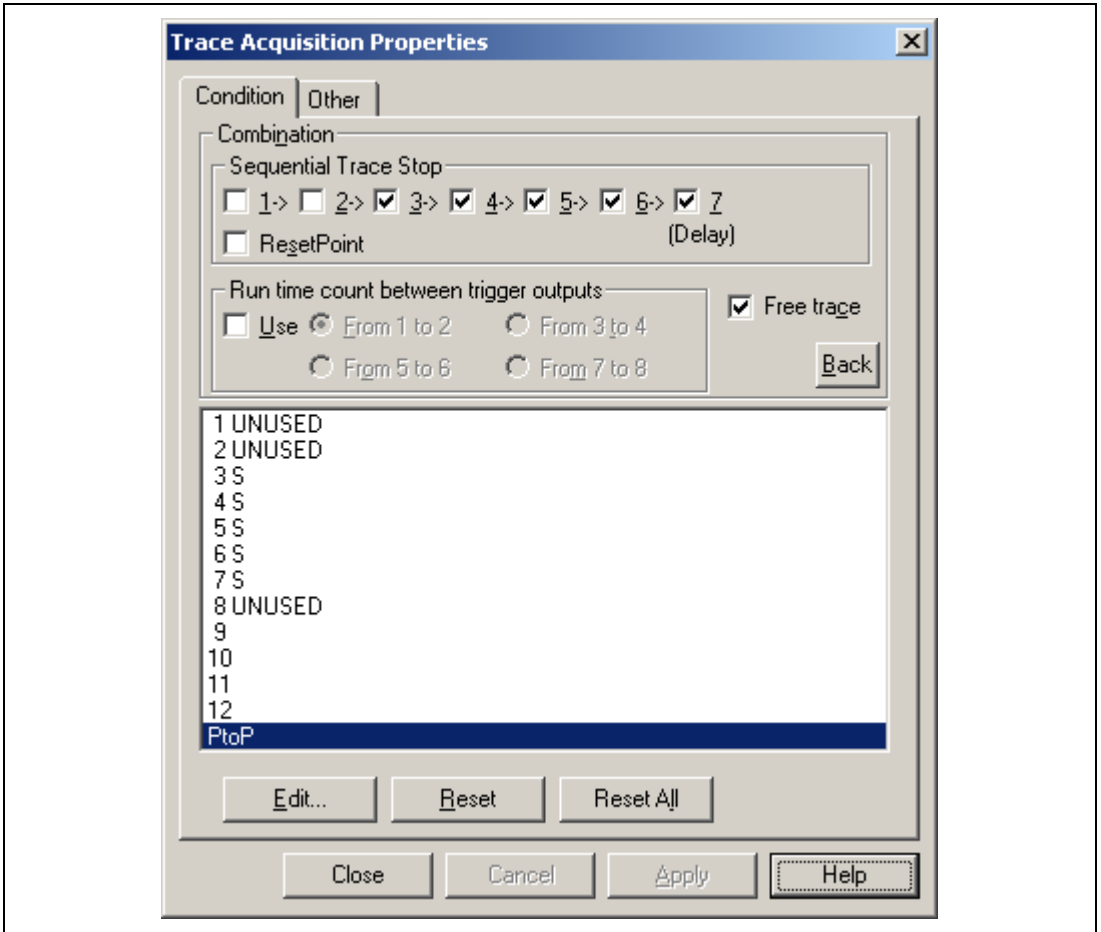

Figure 5.41 [Trace Acquisition Properties] Dialog Box (Sequential Trace Stop)

Checking 5 for [Sequential Trace Stop] enables using channels 3 to 7 as a sequential trace stop. Conditions for channels 3 to 7 before setting the sequential trace stop are maintained as the sequential trace conditions. Set the trace stop condition for channels 3 to 7.

- Notes:
1. Set a multiple of two as the address value when the 16-bit area is accessed.
 2. Set a multiple of four as the address value when the 32-bit area is accessed.

3. The sequential trace stop condition must be set with an interval of six or more bus cycles.

Trace Stop Due to Trace Buffer Overflow: A break occurs when the trace buffer in the E6000H station overflows during trace acquisition.

Select [Stop trace] in [When trace-buffer full] on the [Other] page of the [Trace Acquisition Properties] dialog box.

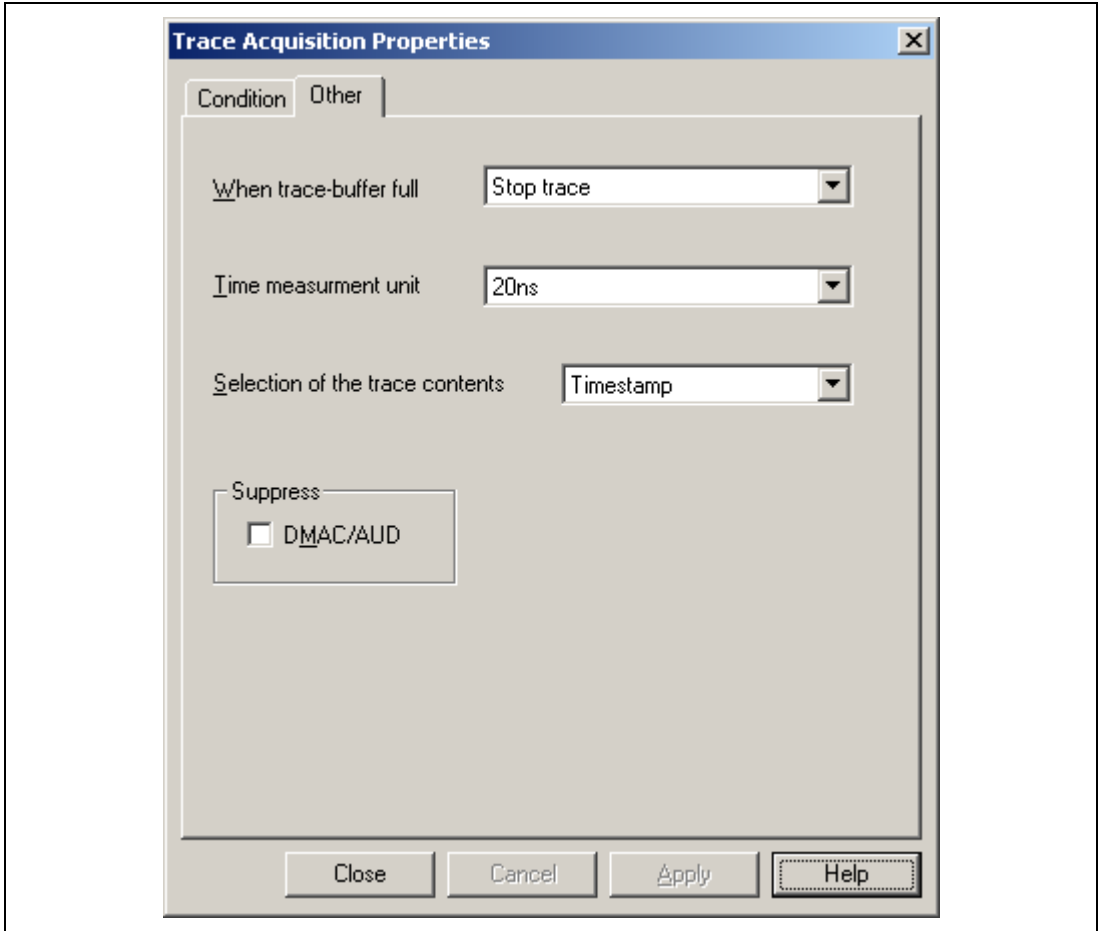

Figure 5.42 [Trace Acquisition Properties] Dialog Box ([Other] Page)

Subroutine Trace Mode:

(a) Overview

Instruction and operand accesses are traced during execution in the range between the start address and end address of a specified subroutine, or of a subroutine specified by its start and end addresses. However, when the specified subroutine calls other subroutines, the called subroutine will not be traced.

The specification of a subroutine trace mode is described (Trace Condition 1 is taken as an example). Select the [Trace] window and click the right-hand mouse button. Select [Acquisition] from the menu, then the [Trace Acquisition Properties] dialog box is displayed. Select Channel 1 from the list box. Selecting [Address Range Trace] on the [Action] page sets the subroutine trace mode.

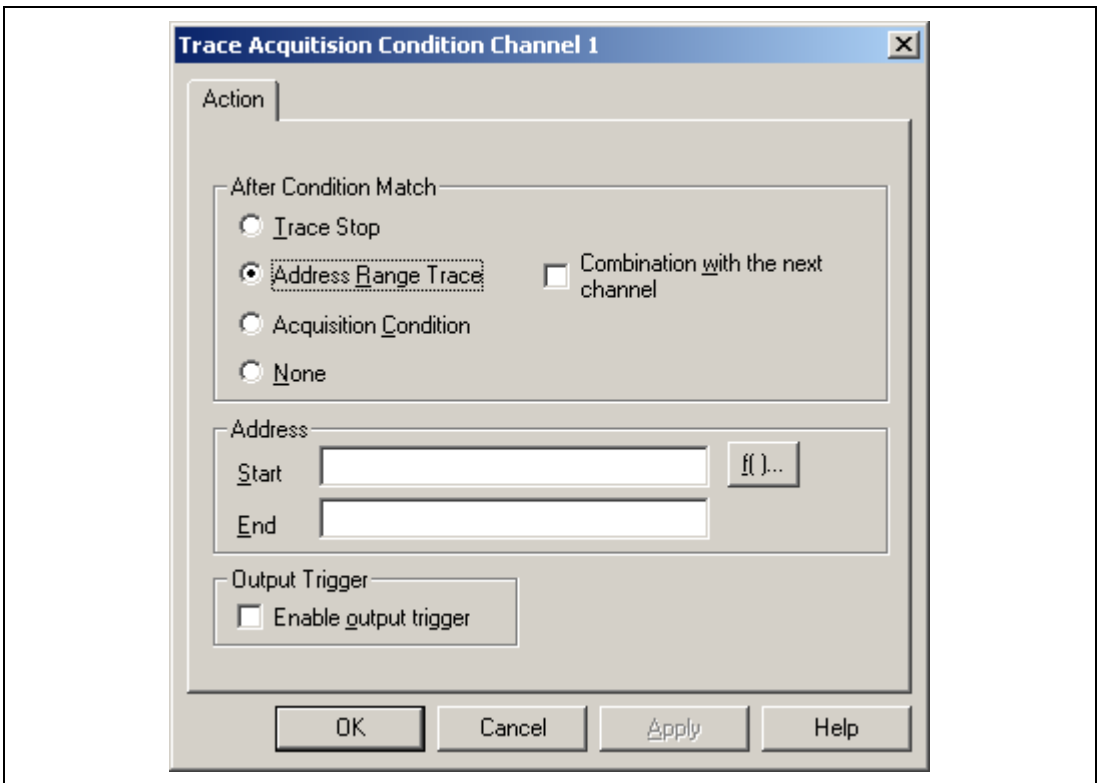

Figure 5.43 Setting the Subroutine Trace Mode ([Action] Page)

When [Combination with the next channel] is selected and each page of the next channel is set, the trace acquisition condition can be set for the subroutine.

When [Combination with the next channel] is selected (only the odd channels can be selected), set each page of the next channel (even channel) corresponding to the selected channels, and click the [OK] button to set the trace acquisition condition.

The [Trace Condition 1] dialog box closes and the display returns to the [Trace Acquisition Properties] dialog box. The specified trace acquisition conditions will now be displayed as channel 1 in the list box. Click the [OK] button to close the [Trace Acquisition Properties] dialog box.

Subroutine trace modes are specified in the same way.

The settings on each page are the same as those of the dialog box for the on-emulator break, except the [Action] page. For details on each page, refer to section 5.6.3, On-Emulator Break.

- Notes:
1. Set a multiple of two as the address value when the 16-bit area is accessed.
 2. Set a multiple of four as the address value when the 32-bit area is accessed.
 3. The subroutine trace mode condition must be set with an interval of six or more bus cycles.

Conditional Trace Mode:

(a) Overview

Cycles are only acquired where the specified conditions are satisfied.

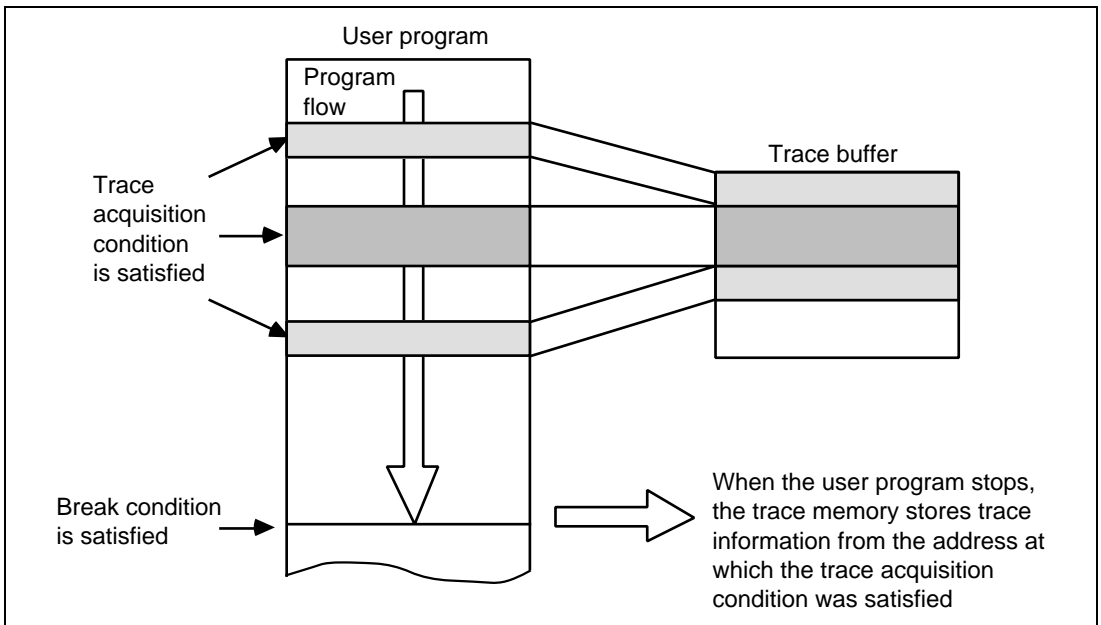

Figure 5.44 Example of Conditional Trace Mode

The conditions for conditional trace mode are shown in table 5.37. Information is acquired when all of the specified conditions (an AND condition) are satisfied.

Table 5.37 Conditional Trace Modes

Condition	Description
Address bus	Satisfied when the value on the address bus matches the specified value.
Data bus	Satisfied when the value on the data bus matches the specified value.
Bus/access type	Satisfied when the bus status condition is as specified.
External interrupt signal	Satisfied when the external interrupt signal levels match the specified conditions.
External probe signal	Satisfied when the external probe (PRB) signal levels match the specified conditions.
Satisfaction count	Satisfied when the specified conditions match the satisfied counts.

- Notes:
1. Set a multiple of two as the address value when the 16-bit area is accessed.
 2. Set a multiple of four as the address value when the 32-bit area is accessed.
 3. The conditional trace mode condition must be set with an interval of six or more bus cycles.

Trace Condition 1 is taken as an example of setting a conditional trace mode.

Place the cursor in the [Trace] window then click the right-hand mouse button to display the pop-up menu. Select [Acquisition...] from the menu, and the [Trace Acquisition Properties] dialog box will appear. Select Channel 1 from the list box. Select [Acquisition Condition] on the [Action] page to set the conditional trace mode.

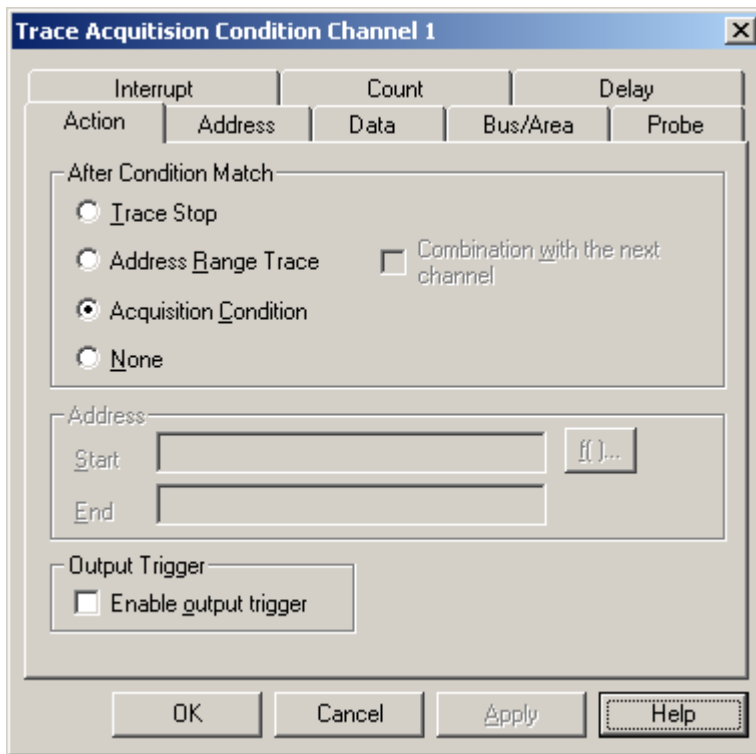

Figure 5.45 Setting the Conditional Trace Mode ([Action] Page)

Trigger Output: A low-level pulse is output from the trigger-output probe when the conditions specified for Trace Condition are satisfied during execution of the user program. For details, refer to figure 5.39 and table 5.34.

Other Conditions: In the [Other] page of the [Trace Acquisition Properties] dialog box, tracing can be specified to stop on the overflow of the trace buffer, suppressing of DMAC or AUD cycles can be selected, and the minimum period for time stamping of acquired bus-tracing information can be specified.

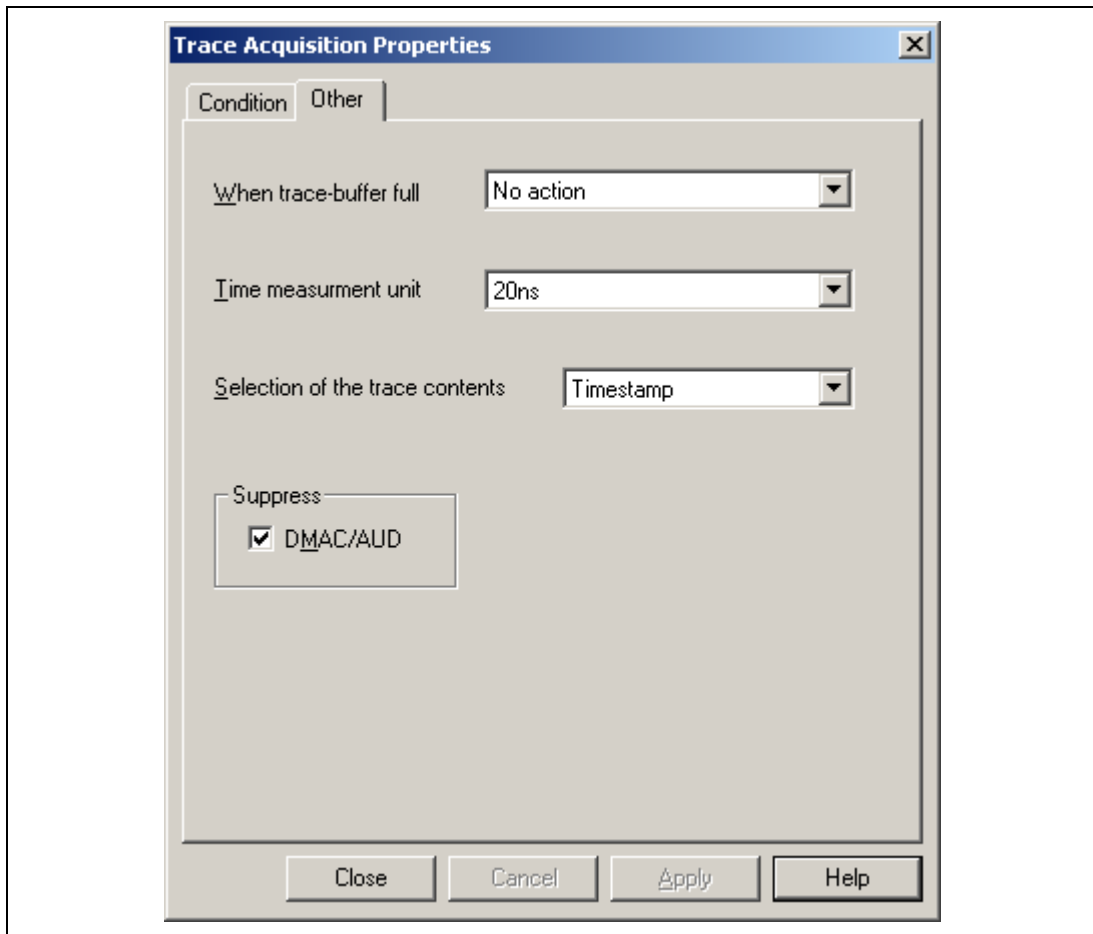

Figure 5.46 [Trace Acquisition Properties] Dialog Box ([Other] Page)

(a) [Suppress]

Cycles that are suppressed (not acquired) are selected. The DMAC and AUD cycles are not acquired when [DMAC/AUD] is checked.

(b) [Time measurement unit]

The minimum period for time stamping is specified.

Table 5.38 [Time measurement unit] Group Box Option

Option	Description
[Time measurement unit]	Selects the minimum time for the time stamping of the measured bus trace information from among the values listed below. 20ns: Time stamping is in minimum time units of 20 ns (default). 1.6us: Time stamping is in minimum time units of 1.6 μ s. 52us: Time stamping is in minimum time units of 52 μ s. CLOCK: Time stamping is in terms of the number of bus-clock cycles, i.e., is synchronized with the cycles of the system clock (ϕ) signal. CLOCK/2: Time stamping is in terms of the number of bus-clock cycles, i.e., is synchronized with 1/2 cycle of the system clock (ϕ) signal. CLOCK/4: Time stamping is in terms of the number of bus-clock cycles, i.e., is synchronized with 1/4 cycle of the system clock (ϕ) signal. CLOCK/8: Time stamping is in terms of the number of bus-clock cycles, i.e., is synchronized with 1/8 cycle of the system clock (ϕ) signal.

Click the [Apply] button to set the minimum time, then click the [Close] button.

5.7.2 External Bus Trace Timing

The acquisition of trace information is synchronized with the rising edge of T2 cycles of the CK signal.

In each bus cycle, the number of cycles between the end of the previous bus cycle and the end of the current bus cycle is measured.

An example of a bus-trace timing for the external probe signal is shown in figure 5.47.

Note: When the external probe signal information is traced, changes in the signal may not be traced if its level changes with certain timings. This is because the signal is not synchronized with the CK signal.

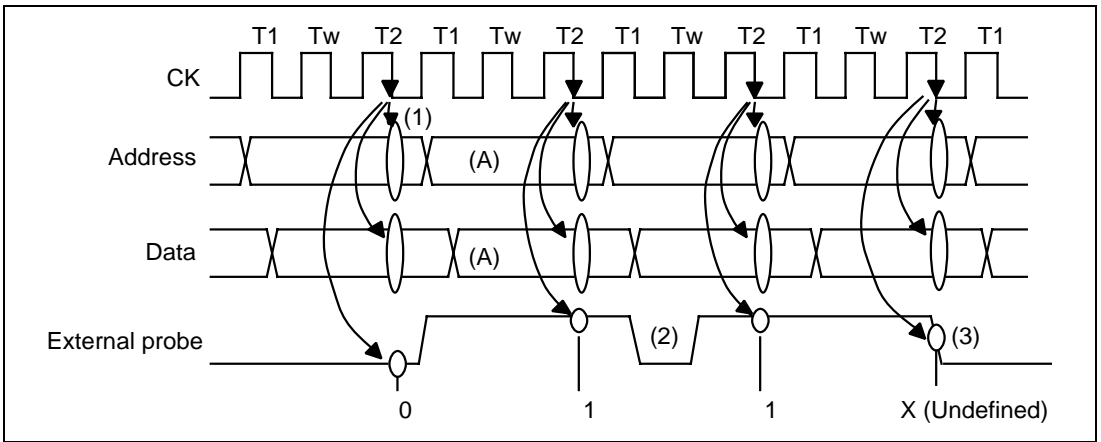

Figure 5.47 Tracing External Probe Signal

(1) External probe signal

(a) Information is traced on the falling edge of the T2 cycle of the CK signal (figure 5.47 (1)).

(b) When the level of the external probe signal changes while information is being acquired, this change will not be included in the trace information (figure 5.47 (2)).

(c) If the sampling edge and the level of an external probe signal change at the same time, the information traced will be undefined (figure 5.47 (3)). If the sampling edge and asynchronous input signal such as NMI or IRQ changes at the same time, the information traced will also be undefined.

(2) Number of clocks

Up to three clock cycles of tracing can take place in one bus cycle (A).

5.7.3 Trace Display

Select the trace display format on the [General] page of the [Trace Filter Properties] dialog box. Select [Filter...] from the pop-up menu of the [Trace] window to produce this dialog box.

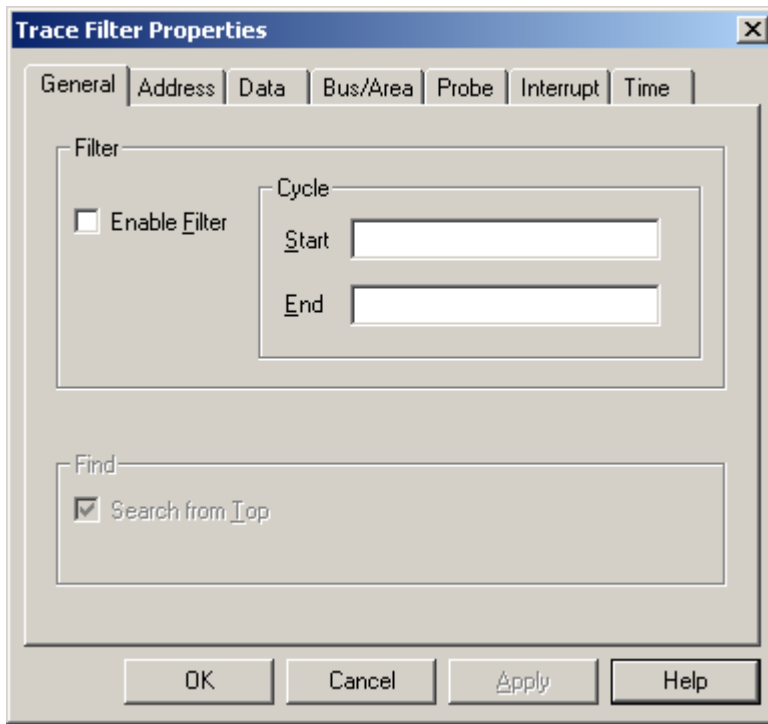

Figure 5.48 [Trace Filter Properties] Dialog Box ([General] Page)

Trace Display: The range for display can be specified by setting the start and end pointers in bus cycles (bus cycle pointers) in [Start] and [End] on the [General] page of the [Trace Filter] dialog box. The pointer is a value relative to the location at which the delay condition has been satisfied. Number of bus cycles before the delay condition has been satisfied are indicated by a minus sign (-), while numbers of cycles after the condition's satisfaction are displayed with a plus sign (+).

Cycle	Address	CS	Label	Code0	Code1	Data	RM	SZ	Bus	Prob	NMI	Irq	Timestamp/Clock	DeltaTime/Clock	Source
-00011	000011e0	C30		NOP		00090000	IF		CPU	1111			0s 1ms 44us260ns	0s 0ms 0us 40ns	
-00010	ffffbfef	C31				000011c6	RD	L	CPU	1111			0s 1ms 44us320ns	0s 0ms 0us 60ns	
-00009	000011c6	C30		LDS.L		00094e26	IF		CPU	1111			0s 1ms 44us420ns	0s 0ms 0us100ns }	
-00008	000011c8	C30		RTS	NOP	000b0009	IF		CPU	1111			0s 1ms 44us460ns	0s 0ms 0us 40ns	
-00007	ffffbfef	C30				00001010	RD	L	CPU	1111			0s 1ms 44us560ns	0s 0ms 0us100ns	
-00006	00001010	C30		MOV.L	MOV.L	40064807	IF		CPU	1111			0s 1ms 44us660ns	0s 0ms 0us100ns	MOV.L
-00005	00001014	C30		LDC	JSR	400e480b	IF		CPU	1111			0s 1ms 44us760ns	0s 0ms 0us100ns	LDC
-00004	0000102c	C30				000000f0	RD	L	CPU	1111			0s 1ms 44us820ns	0s 0ms 0us 60ns	
-00003	00001030	C31				00001034	RD	L	CPU	1111			0s 1ms 44us860ns	0s 0ms 0us 40ns	
-00002	00001018	C31		NOP		0009001b	IF		CPU	1111			0s 1ms 44us920ns	0s 0ms 0us 60ns	NOP
-00001	00001034	C30	_main			4E227fc8	IF		CPU	1111			0s 1ms 45us 20ns	0s 0ms 0us100ns	void main(void)
+00000	-----									1111			0s 1ms 45us520ns	0s 0ms 0us500ns	

Figure 5.49 [Trace] Window

The items shown in table 5.39 are displayed as trace information in the [Trace] window.

Table 5.39 Trace Information Items and Display Format in [Trace] Window

Item	Description and Format
Cycle	Bus cycle pointer.
Address	32-bit address bus values in 4-bit units. The invalid cycle is shown as '---- ----'.
CS	Areas (CS0 to 3) in the user expansion space in the expansion mode. Nothing is displayed in the non-expansion mode. This item may be displayed before or after the bus cycle that accessed the area in the user expansion space.
Label	Label name related to an address (if any).
Code0	Upper 16-bit instruction code being executed. Nothing is displayed here in cycles that are not instruction-execution cycles.
Code1	Lower 16-bit instruction code being executed. Nothing is displayed here in cycles that are not instruction-execution cycles.
Data	32-bit data bus values in 4-bit units.
RW	Whether the cycle was for reading, writing, or fetching. RD: read cycle WR: write cycle IF: fetch cycle
SZ	Data size to be accessed. L: longword W: word B: byte
Bus	Bus-cycle type conditions for trace. Cycles for CPU, DMAC, and AUM are displayed as CPU, DMAC, and AUM, respectively.
Prob	External probe (PRB) signal state. x4x3x2x1 (xn is the state of PRBn) (0: low level; 1: high level)
NMI	NMI signal state. (0: low level; 1: high level)
IRQ	IRQ0 to IRQ7 signal state. x7x6x5x4x3x2x1x0 (xn is the state of IRQn) (0: low level; 1: high level)
Time Stamp	Time stamp. xxxxmsxxxusxxxns (s: second; ms: millisecond; us: microsecond; ns: nanosecond) When IRQ is selected, an approximate value is displayed for Time Stamp. Time Stamp and Clock are displayed by EORed.

Table 5.39 Trace Information Items and Display Format in [Trace] Window (cont)

Item	Description and Format
Deltatime	Difference of time immediately before the cycle.
Clock	Number of clock cycles from the end of the previous bus cycle to the end of the current bus cycle. Only one of Time Stamp or Clock can be displayed at a time.
Source	The corresponding source line to the cycle. Clicking in the [Source] column jumps to the [Source] window.

5.7.4 Trace Search Functions

The emulator has the two functions for searching for trace information that are shown in table 5.40.

Table 5.40 Trace Search Functions

Search Function	Description
Trace Filter	Displays all trace information that satisfies the specified conditions.
Trace Find	Jumps to the next record of trace information that satisfies the specified conditions

Trace Filter Function: This function displays all trace information that satisfies the conditions specified in the [Trace] window. The search conditions can be specified in the [Trace Filter Properties] dialog box.

Place the cursor in the [Trace] window then click the right-hand mouse button to display the pop-up menu. Select [Filter...] from the menu, and the [Trace Filter Properties] dialog box will appear. Select [Enable Filter] on the [General] page.

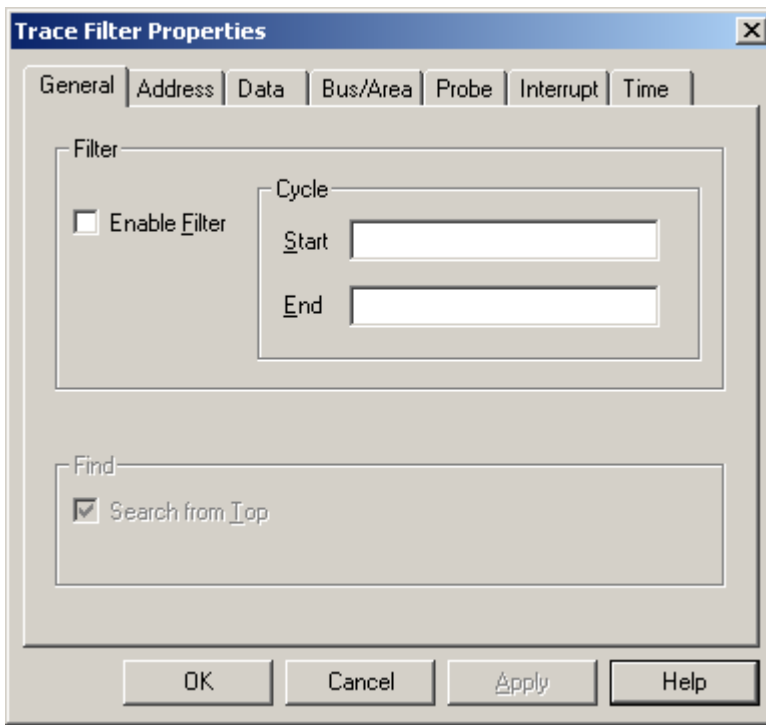

Figure 5.50 [Trace Filter Properties] Dialog Box ([General] Page)

If there is no trace information in updating the [Trace] window, 'No trace data' is displayed in the window (nothing is displayed when there is no trace information at opening the [Trace] window).

Table 5.41 [General] Page Option

Option	Description
Filter	Sets a range to be displayed.
[Cycle]	Set negative values for as cycles before the delay condition was satisfied with the bus cycle on which the conditions are satisfied as the origin (0). [Start] is the pointer to the first bus cycle. [End] is the pointer to the last bus cycle. The input area must always be set.

Specify the required conditions on the corresponding pages, then click the [OK] button. The [Trace Filter Properties] dialog box closes and the search results are displayed in the [Trace] window.

The trace search conditions that can be specified and the corresponding pages in the [Trace Filter Properties] dialog box are shown in table 5.42.

Table 5.42 Trace Search Conditions and Pages in the [Trace Filter Properties] Dialog Box

Page	Condition	Description
[General]	—	Sets trace-search range.
[Address]	Address bus	Searches for records in which the value on the address bus, program counter, or memory access area matches the specified condition.
[Data]	Data bus	Searches for records in which the value on the data bus matches the specified condition.
[Bus/Area]	Bus state	Searches for records in which access type, read/write access, and BREQ signal match the specified condition.
[Probe]	External probe signal	Searches for records in which the external probe signal levels match the specified condition.
[Interrupt]	External interrupt signal	Searches for records in which the NMI, RES, MRES, or IRQ0 to IRQ7 signal levels match the specified condition.
[Time]	Time stamp	Searches for records in which the time stamp matches the specified condition (time or range).

The setting of conditions for [Data] and [Probe] is the same as setting the on-emulator break condition. For details on specifying the conditions, refer to section 5.6.3, On-Emulator Break.

The descriptions given below are of [Address], [Bus State], [Interrupt], and [Time] settings.

Note: During using the Trace Filter function, do not save the trace.

(a) [Address] Page

Use the [Address] page to specify bus conditions for use in searching for address bus information.

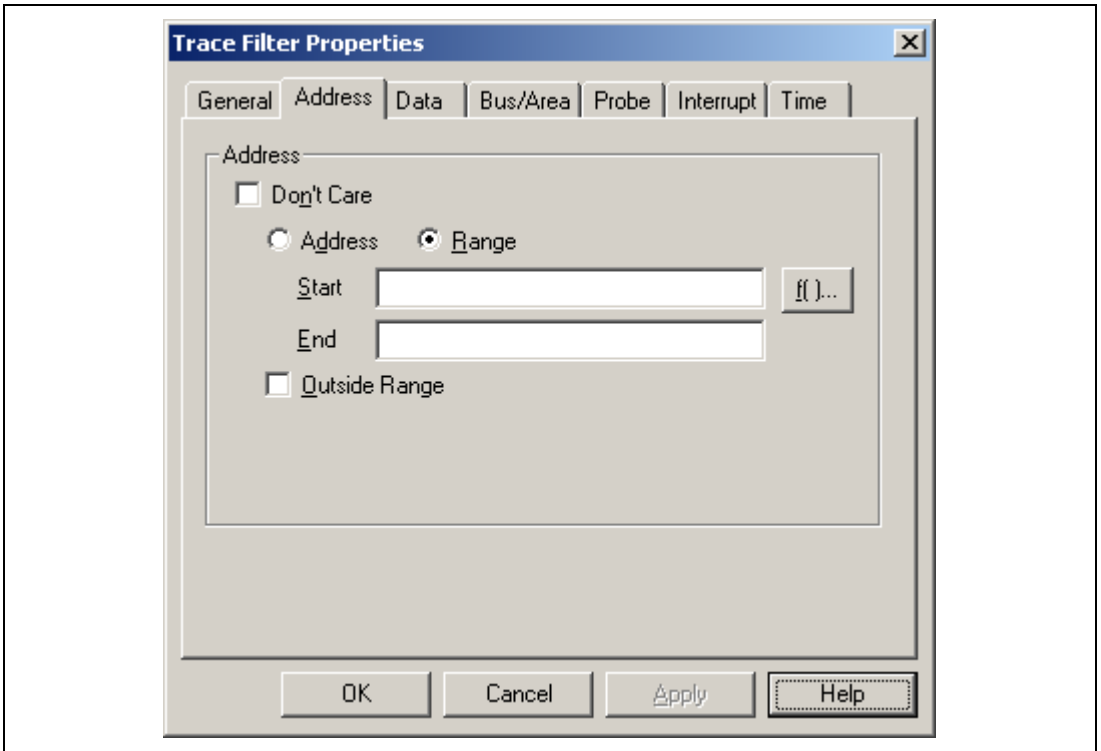

Figure 5.51 [Trace Filter Properties] Dialog Box ([Address] Page)

Table 5.43 [Address] Page Options

Option	Description
[Don't Care]	No address bus condition is set.
[Address]	Selects the range set as [Start] or [Mask] as a trace-search condition.
[Range]	Selects the range set as [Start] to [End] as a trace-search condition.
[Start]	Sets the (start) address value as a numeric or a symbol.
[End]	When [Range] is selected, sets the (end) address value as a numeric or symbol.
[Outside Range]	Sets the condition that has not been set as a trace-search condition.

(b) [Bus/Area] Page

Use the [Bus/Area] page to specify bus conditions for use in searching, i.e., access type and read or write cycle information.

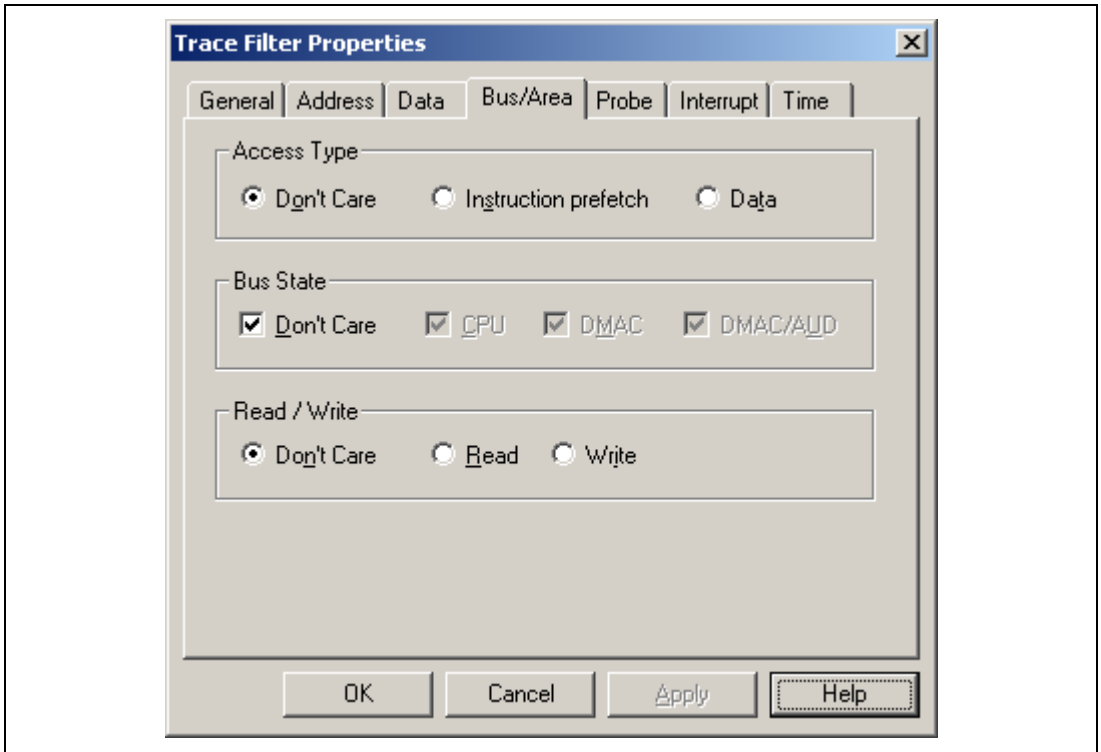

Figure 5.52 [Trace Filter Properties] Dialog Box ([Bus/Area] Page)

Table 5.44 [Bus/Area] Page Options

[Access Type] Group Box

Option	Description
[Don't Care]	Sets all access types as the search condition.
[Instruction prefetch]	Sets CPU instruction fetch cycles as the search condition.
[Data]	Sets data access cycles as the search condition.

[Bus State] Group Box

Option	Description
[Don't Care]	Sets all access types as the search condition.
[CPU]	Sets CPU cycles as the search condition.
[DMAC/AUD]	Sets DMAC/AUD cycles as the search condition.

[Read/Write] Group Box

Option	Description
[Don't Care]	Sets all access types as the search condition.
[Read]	Sets read cycles as the search condition.
[Write]	Sets write cycles as the search condition.

(c) [Interrupt] Page

Use the [Interrupt] page to specify conditions for the external interrupt signals (IRQ0 to IRQ7) and NMI signal for use in searching.

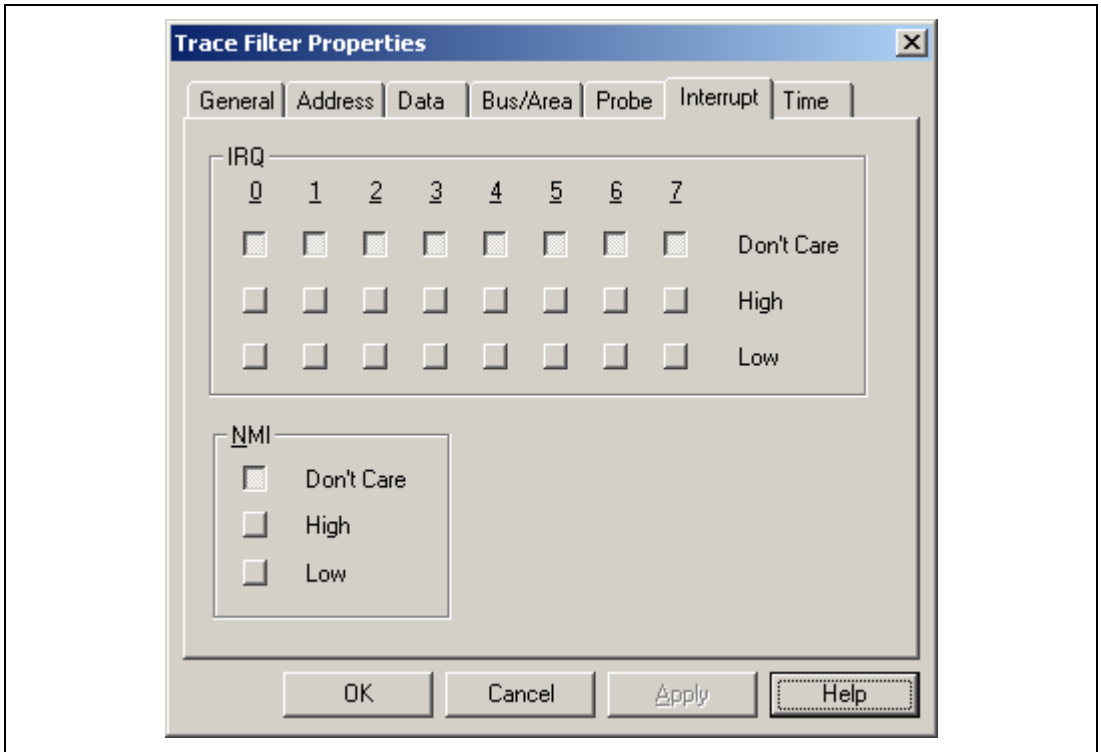

Figure 5.53 [Trace Filter Properties] Dialog Box ([Interrupt] Page)

Table 5.45 [Interrupt] Page Options

[IRQ0 to IRQ7] Group Box

Option	Description
[Don't Care]	The state of the external interrupt signal is not a search condition.
[High]	Sets the high level of the external interrupt signal as a search condition.
[Low]	Sets the low level of the external interrupt signal as a search condition.

[NMI] Group Box

Option	Description
[Don't Care]	The state of the NMI signal is not a search condition.
[High]	Sets the high level of the NMI signal as a search condition.
[Low]	Sets the low level of the NMI signal as a search condition.

(d) [Time] Page

Use the [Time] page to specify time-stamp conditions for use in the search for external bus trace information.

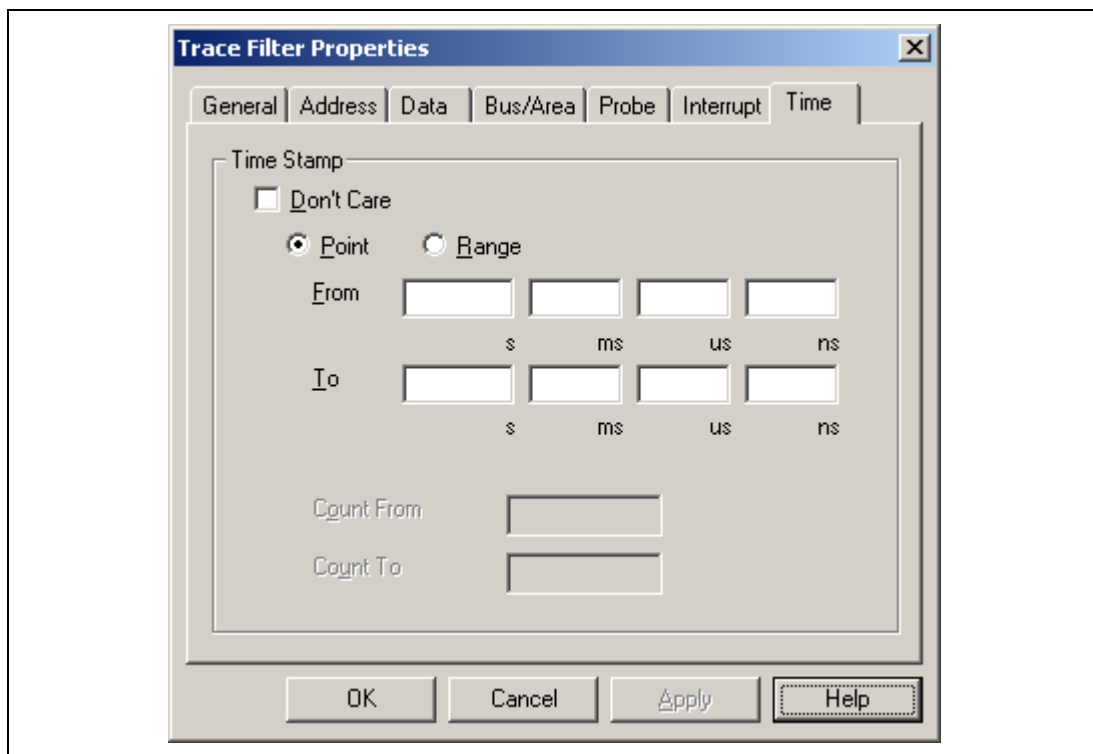

Figure 5.54 [Trace Filter Properties] Dialog Box ([Time] Page)

Table 5.46 [Time] Page Options

Option	Description
[Don't Care]	No time stamp condition is set.
[Point]	Sets the trace-search condition to values above the value set as [From].
[Range]	Sets the range set by [From] to [To] as a trace-search condition.
[From]	Sets the time-stamp value from which the valid range starts as a numeric (decimal). When any number is omitted, 0 is assumed. [s]: (start) second (0 to 999999) [ms]: (start) millisecond (0 to 999) [us]: (start) microsecond (0 to 999) [ns]: (start) nanosecond (0 to 999)
[To]	When [Range] is selected, sets the time-stamp value of the end of the range of valid values as a numerical value (decimal). When any number is omitted, 0 is assumed. [s]: (start) second (0 to 999999) [ms]: (start) millisecond (0 to 999) [us]: (start) microsecond (0 to 999) [ns]: (start) nanosecond (0 to 999)

Note: Do not use this page if number of clock cycles have been selected for display.

5.7.5 Trace Find Functions

This function makes the display jump to the trace information item that satisfies the specified conditions in the [Trace] window. The search conditions can be specified in the [Trace Find Properties] dialog box. Search conditions are the same as those for the trace filter functions.

Place the cursor in the [Trace] window then click the right-hand mouse button to display the pop-up menu. Select [Find...] from the menu. Click [Find Next] in the pop-up menu of the [Trace] window to jump to the next trace information item that satisfies the specified conditions.

(a) [General] page

Select the [General] page, then select the [Search from top] check box to search from the start of the trace information.

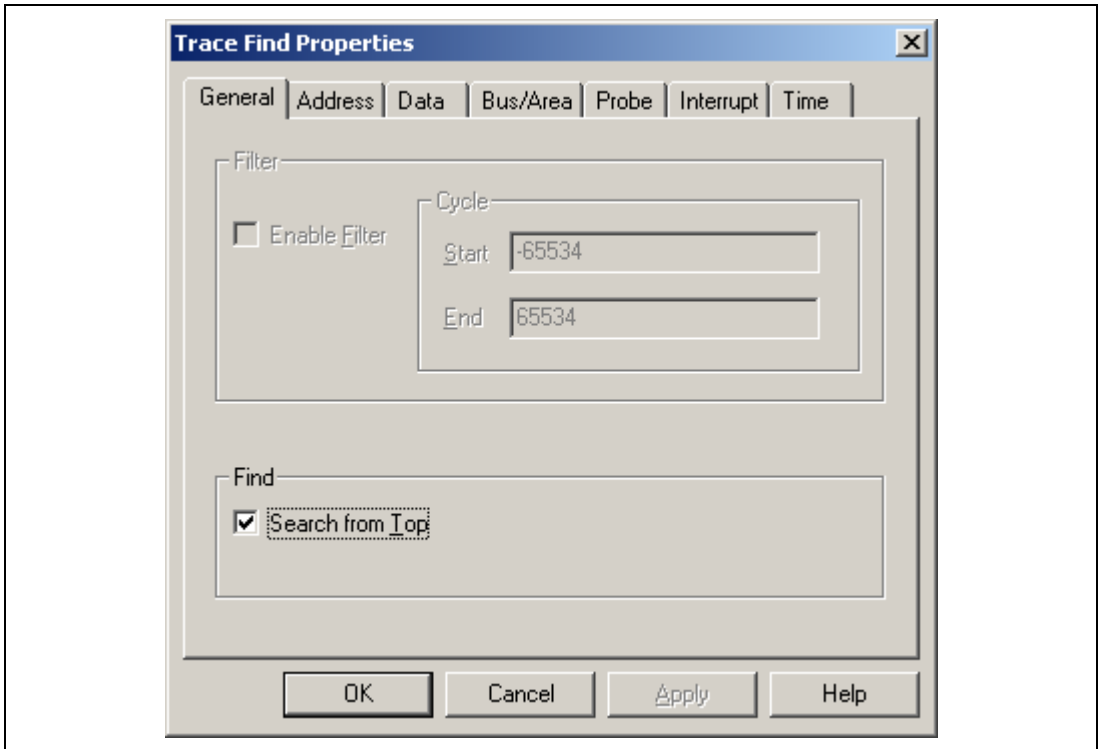

Figure 5.55 [Trace Find Properties] Dialog Box ([General] Page)

5.8 Measurement of Execution Time

5.8.1 Measuring Normal Execution Time

This function provides a way of measuring the total time taken to execute the user program. The user can use any of the methods shown in section 5.3.1, Execution, to start the user program. The total execution time is the total time with the user program in execution; from the start of execution until the program stops due to the satisfaction of a break condition.

The resulting measurement is displayed next to [Run Time Count] in the [Platform] page of the [System Status] window.

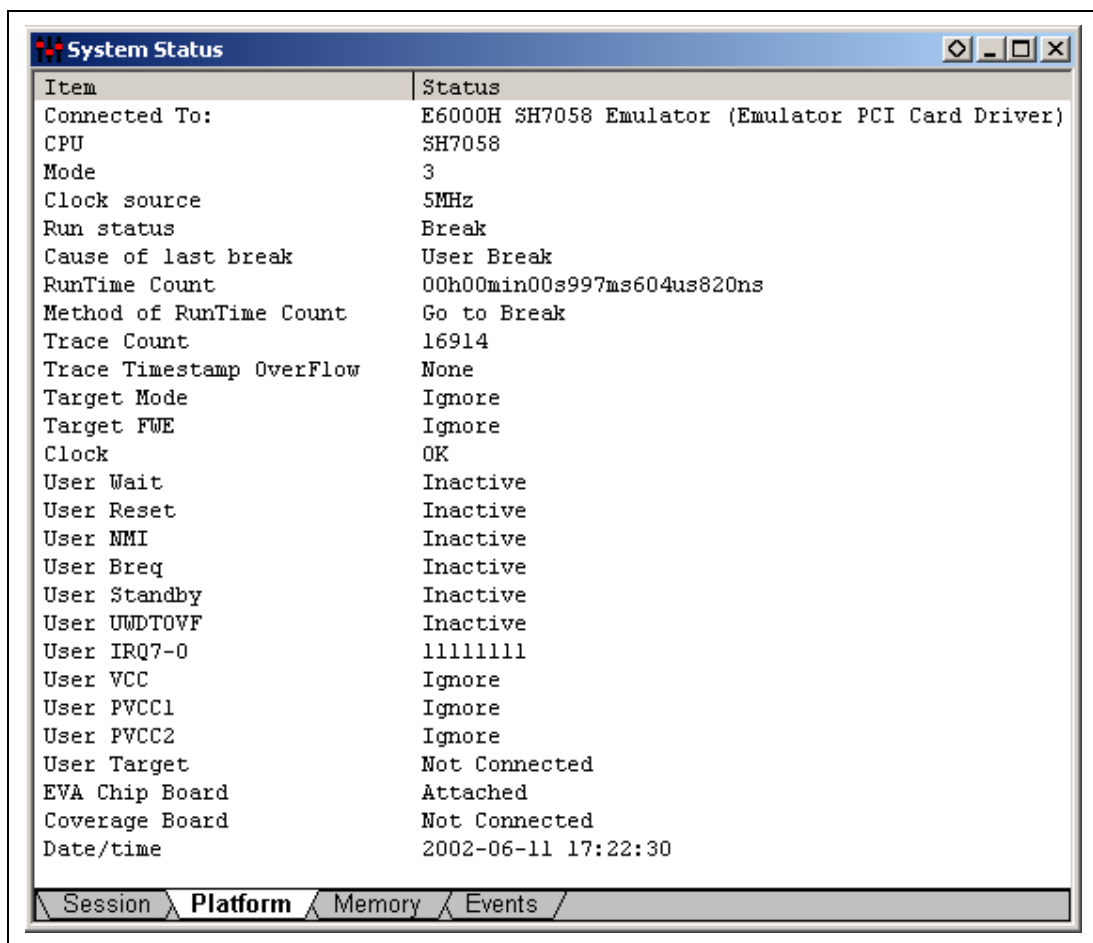

Figure 5.56 [System Status] Window (Display of Execution Time)

In the window, the user program execution time will be displayed as decimal numbers of hours, minutes, etc. The user can use the [Timer Resolution] on the [General] page in the [Configuration] dialog box to set a maximum period of measurement. The maximum times are approximately 15,860 hours (with a sampling interval during execution of 52 μ s), 488 hours (with a sampling interval during execution of 1.6 μ s), or 6 hours (with a sampling interval during execution of 20 ns).

5.8.2 Measuring Execution Time between Satisfaction of Specified Conditions

(1) Point To Point Time Measurement

This function is implemented by measuring the time interval of the user program with a trigger output of On Chip Break.

The execution time is measured from the satisfaction of On Chip Break 7 until the satisfaction of On Chip Break 8. After On Chip Break 7 has been satisfied, the user program stops on the satisfaction of On Chip Break 8. 'On Chip Break' will be displayed as the cause.

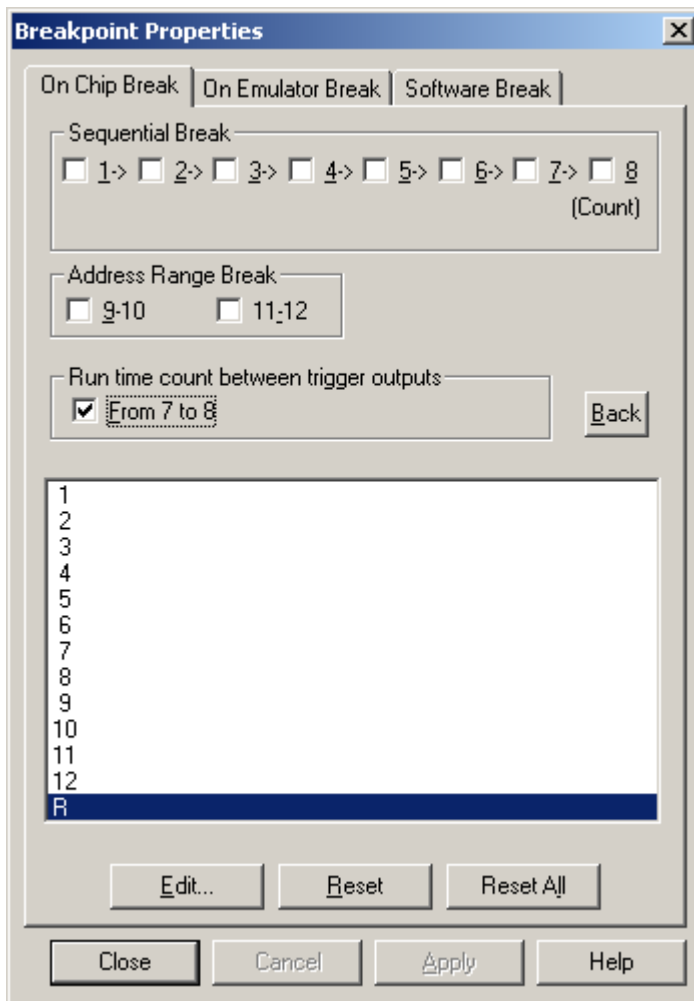

Figure 5.57 [Breakpoint Properties] Dialog Box ([On Chip Break] Page)

Select [From 7 to 8] in the [Point To Point Time Measurement] on the [Breakpoint Properties] dialog box.

Set the measurement start condition for break channel 7 from the [On Chip Break 7] dialog box, and the measurement end condition for break channel 8 from the [On Chip Break 8] dialog box. After setting, the execution time can be measured when the user program is executed.

The measured result of Point To Point Time Measurement is displayed on the [Platform] page in the [System Status] window.

Notes: 1. For the measurement time, the measurement counter used depending on the selected status of [Enable performance counter], which is set on the [General] page in the [Configuration] dialog box, is changed.

When [Enable performance counter] is selected and the counter for measurement has 24 bits, the user can select approximately 14 minutes (with a sampling interval during execution of 52 μ s), 26 seconds (with a sampling interval during execution of 1.6 μ s), or 0.33 seconds (with a sampling interval during execution of 20 ns).

When [Enable performance counter] is not selected and the counter for measurement has 40 bits, the user can select approximately 15,860 hours (with a sampling interval during execution of 52 μ s), 488 hours (with a sampling interval during execution of 1.6 μ s), or 6 hours (with a sampling interval during execution of 20 ns).

2. This function is implemented by using a trigger output of On Chip Break. Therefore, when this function is set, [Output Trigger] on the [Action] page of channel 7 or 8 cannot be selected by default.

5.9 Performance Analysis Function

Performance analysis applies functions of the emulator to the measurement of performance.

5.9.1 Measuring with E6000H Station Function

The emulator's performance analysis function is for measuring the efficiency of parts of a user program in terms of their execution times against the overall execution time, and for measuring the number of times a part of the user program is executed.

- Setting the Conditions for Performance Measurement

In the HDI, the user can set the execution efficiency and the execution count through a certain dialog box and display the measured results in the [Performance Analysis] window.

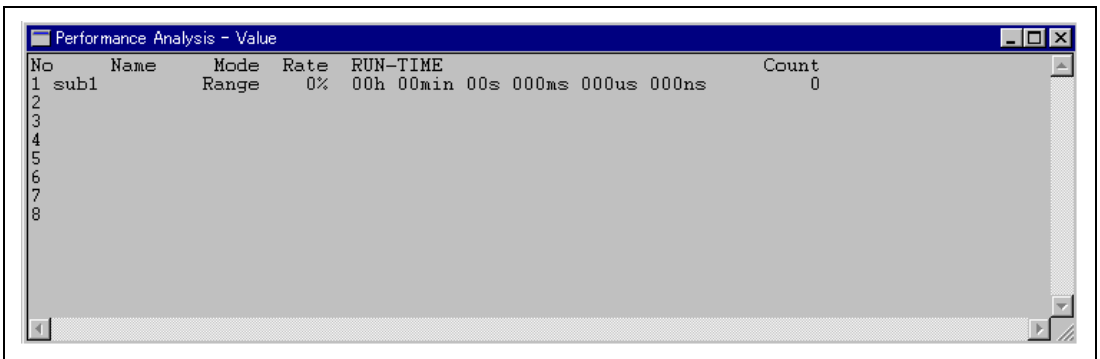

No	Name	Mode	Rate	RUN-TIME	Count
1	sub1	Range	0%	00h 00min 00s 000ms 000us 000ns	0
2					
3					
4					
5					
6					
7					
8					

Figure 5.58 [Performance Analysis] Window

In the [Performance Analysis] window, you can assign any of eight independent channels. To set a condition, click [Conditions] in the pop-up menu of the [Performance Analysis] window to open the [Performance Analysis Condition] dialog box.

Measurement Mode: Table 5.47 shows the measurement modes.

Table 5.47 Measurement Modes

Measurement Mode	Description
Time Of Specified Range Measurement	<p>Measures the amount of time spent and the execution count during the last program run in the range between start address and end address. Start measurement when the program has been prefetched in the specified range between start address and end address. Then stop measurement when the program has been prefetched out of the specified range. Restart measurement when the program has been prefetched in the specified range. The execution count is counted whenever the program of the end address in the specified range is fetched. Measured result of the amount of time spent does not include the run time called in the specified range.</p> <p>Set the conditions in the [Performance Analysis Condition 1 to 8] dialog box.</p>
Start Point To End Point Measurement	<p>Measures the amount of time spent and the execution count during the last program run in the range between start address and end address. Start measurement when the program has been prefetched in the specified range of the start address. Then stop measurement when the program of the end address has been prefetched. The execution count is counted whenever the program of the end address in the specified range is prefetched. Measured result of the amount of time spent includes the run time called in the specified range. For points 1 to 4, the maximum and minimum times in the specified range are measured.</p> <p>Set the conditions in the [Performance Analysis Condition 1 to 8] dialog box.</p>
Start Range To End Range Measurement	<p>Start time measurement in the prefetch cycle of the start address range. Then stop measurement in the prefetch cycle of the end address range. The execution count is counted up whenever the end address range has passed.</p> <p>Set the conditions in the [Performance Analysis Condition 1, 3, 5, 7] dialog box.</p>
Access Count Of Specified Range Measurement	<p>Measure the number of counts that accessed the address range of access area from the range specified with the start address and end address. The execution time in the range is measured by Time Of Specified Range Measurement.</p> <p>Set the conditions in the [Performance Analysis Condition 1, 3, 5, 7] dialog box.</p>

Table 5.47 Measurement Modes (cont)

Measurement Mode	Description
Called Count Of Specified Range Measurement	Measure the number of counts that called the call range from the range specified with the start address and end address. The execution time in the range is measured by using the Time Of Specified Range Measurement. Specify the start and end addresses in the specified subroutine for the call range. Set the conditions in the [Performance Analysis Condition 1, 3, 5, 7] dialog box.

- Notes:
1. Execution of the subroutine is measured by using the value of address bus on the prefetch cycle. When the start or end address is set to an address of the instruction just after a branch instruction or the delay slot instruction, correct measurement is not possible.
 2. In Access Count Of Specified Range Measurement, accessing by the DMA is not counted.
 3. For [Time Resolution] of [Configuration Properties] selected from [Configure Platform], when the performance measurement condition is set, a value is fixed and cannot be changed.

- Example of Time Of Specified Range Measurement

An example of Time Of Specified Range Measurement will be described below:

Here, the start address is assumed to be H'1000 and the end address to be H'1FFF. When the user program is running, the emulator will measure the execution time of the user program in the address range from H'1000 to H'1FFF. When the user program jumps to address H'3000, measurement by the emulator will stop. When the user program returns from address H'3FFF, measurement by the emulator will start again.

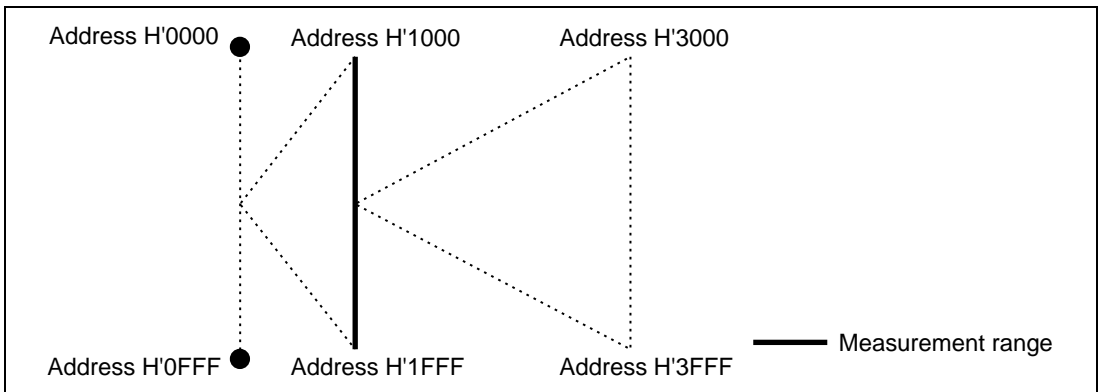

Figure 5.59 Example of Time Of Specified Range Measurement

- Example of Start Point To End Point Measurement

In Start Point To End Point Measurement, the emulator starts to measure the execution time after it has passed the start address and continues to measure the time until it reaches the end address.

An example of the use of Start Point To End Point Measurement is described below:

Here, the start address is assumed to be H'1000 and the end address to be H'1FFF. When the user program is running, the emulator will start to measure the execution time of the user program from the start address (H'1000) until the user program reaches the end address (H'1FFF). When the emulator starts to measure the execution time, it will continue to measure until the user program reaches address H'1FFF or until user program emulation breaks. Therefore, the emulator will continue to measure the execution time of the user program after execution of the user program has jumped to address H'3000.

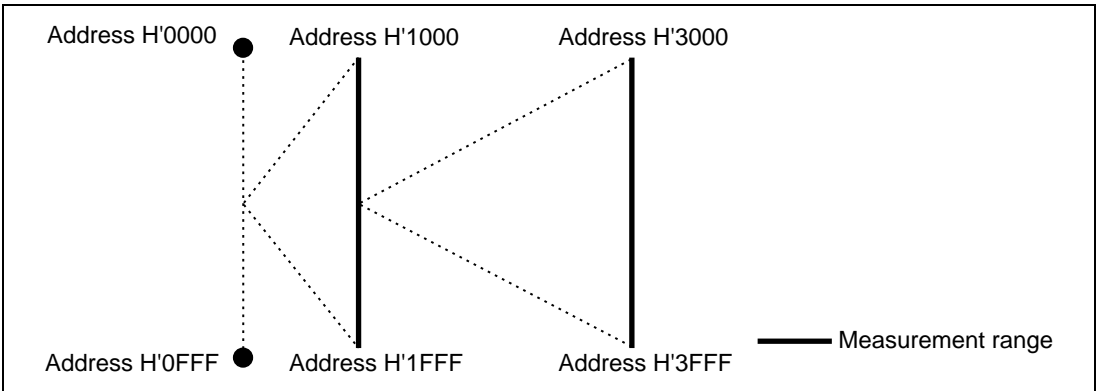

Figure 5.60 Example of Start Point To End Point Measurement

- Example of Start Range To End Range Measurement

In Start Range To End Range Measurement, the emulator starts to measure the execution time of the user program in the start address range specified by the user, and continues to measure the execution time of the user program until the user program reaches the end address range.

An example of the use of Start Range To End Range Measurement is described below:

Here, the start address range is assumed to be from H'1000 to H'13FF and the end address range to be from H'1C00 to H'1FFF. While the user program is running, the emulator will start to measure the execution time of the user program from the start address range (H'1000 to H'13FF) until the user program reaches the end address range (H'1C00 to H'1FFF). When the emulator starts to measure the execution time of the user program, it will not stop until the user program reaches the end address range (H'1C00 to H'1FFF) or a break occurs during emulation. Therefore, the emulator will continue to measure the execution time when the user program jumps to address H'3000.

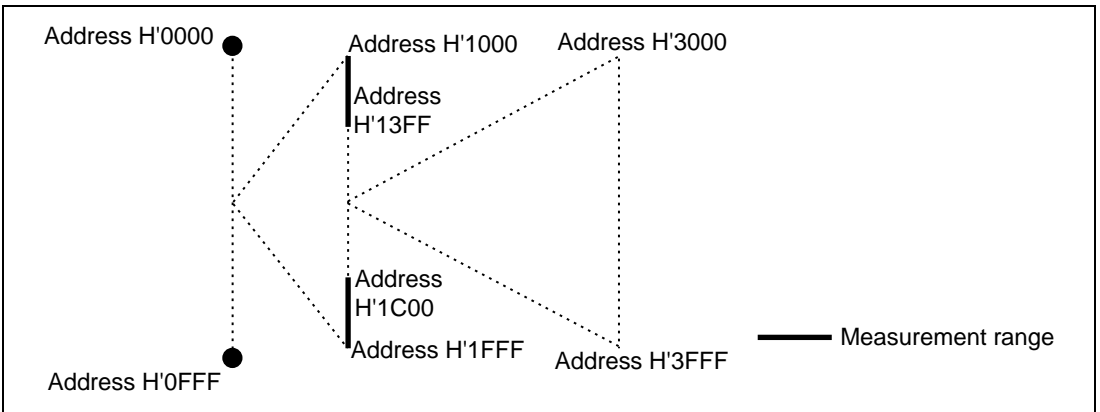

Figure 5.61 Example of Start Range To End Range Measurement

A list of subroutine measurement modes that can be set in the [Performance 1 to 8] dialog box is shown in table 5.48.

Table 5.48 Modes that are Available in the [Performance 1 to 8] Dialog Boxes

Mode	Channel Number for Performance Analysis							
	1	2	3	4	5	6	7	8
Time Of Specified Range Measurement	o	o	o	o	o	o	o	o
Start Point To End Point Measurement	o	o	o	o	o	o	o	o
Start Range To End Range Measurement	o	×	o	×	o	×	o	×
Access Count Of Specified Range Measurement	o	×	o	×	o	×	o	×
Called Count Of Specified Range Measurement	o	×	o	×	o	×	o	×

Note: o: Can be set.
 ×: Cannot be set.

Notes: 1. Two channels are necessary to specify the start and end address ranges for Start Range To End Range Measurement. Therefore, settings for Start Range To End Range Measurement can only be made on odd-numbered channels. In the Access Count Of Specified Range Measurement mode, two channels are required to specify the start and end addresses of the area accessed by the subroutine specified by its start and end addresses. Therefore, settings for the Access Count Of Specified Range Measurement mode can only be made on odd-numbered channels. In the Called Count Of Specified Range Measurement mode, two channels are required to specify the start and end addresses of the subroutine accessed by the first subroutine, itself specified by its start

and end addresses. Therefore, settings for the Called Count Of Specified Range Measurement mode can only be made on odd-numbered channels.

2. In Start Point To End Point Measurement, the minimum and maximum time is measured only for channel numbers 1 to 4.

Performance Measurement Time: For the measurement time, the measurement counter used depending on the selected status of [Enable performance counter], which is set on the [General] page in the [Configuration] dialog box, is changed.

When [Enable performance counter] is selected and the counter for measurement has 40 bits, you can select approximately 15,860 hours (with a sampling interval during execution of 52 μ s), 488 hours (with a sampling interval during execution of 1.6 μ s), or 6 hours (with a sampling interval during execution of 20 ns).

When [Enable performance counter] is not selected and the counter for measurement has 24 bits, the user can select approximately 14 minutes (with a sampling interval during execution of 52 μ s), 26 seconds (with a sampling interval during execution of 1.6 μ s), or 0.33 seconds (with a sampling interval during execution of 20 ns).

Notes: 1. For measurement, the following two differences must be considered:

(1) ± 1 -resolution (when the resolution is 20 ns, an error is ± 20 ns)

The ± 1 -resolution will be generated when the user program execution is started or stopped (break) and the start and end conditions are satisfied.

(2) Frequency stability of crystal oscillator for measurement: $\pm 0.01\%$

2. Set the time interval from the satisfaction of end condition to the satisfaction of the next start condition as larger than one resolution in each measurement mode. If this interval is less than one resolution, the time from the satisfaction of end condition to the satisfaction of the next start condition is measured.
3. In Time Of Specified Range Measurement, the end condition is satisfied when the address is outside of the specified range. In Start Point To End Point Measurement and Start Range To End Range Measurement, the end condition is satisfied when the specified condition has been satisfied. If the same address is specified for them, the measured result of Time Of Specified Range measurement will be larger than that of Start Point To End Point Measurement and Start Range To End Range Measurement.
4. The address bus value of the prefetch cycle is used for each measurement. The measurement is not correct when the end address condition is specified for the address adjacent to the next address of the branch or delayed slot instruction. When the bus trace is displayed, check the operation after the cycle where the branch instruction has been prefetched and set the address for the prefetch cycle that is not executed at branch as the end address.

How to Set the Conditions for Measuring the Performance: To set the conditions for measuring the performance, use the [Performance Analysis Conditions] dialog box that can be displayed by clicking [Conditions] in the pop-up menu on the [Performance Analysis] window. An example of the use of Performance Analysis 1 is described below:

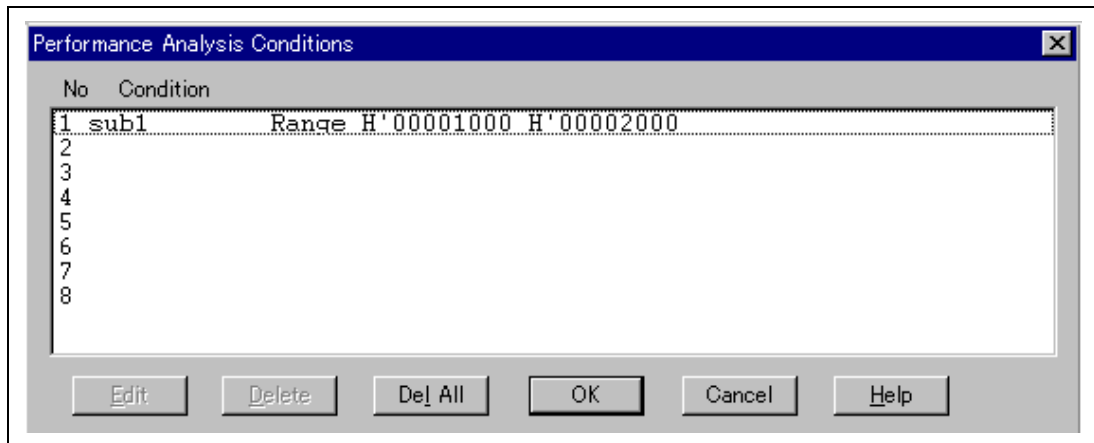

Figure 5.62 [Performance Analysis Conditions] Dialog Box

Table 5.49 [Performance Analysis Conditions] Dialog Box Options

Option	Description
[Condition]	Displays the execution time and the settings of the subroutines which execution count is measured. Empty is displayed when nothing is set. 1 (Performance Analysis 1 setting) 2 (Performance Analysis 2 setting) 3 (Performance Analysis 3 setting) 4 (Performance Analysis 4 setting) 5 (Performance Analysis 5 setting) 6 (Performance Analysis 6 setting) 7 (Performance Analysis 7 setting) 8 (Performance Analysis 8 setting)
[Edit...]	Modifies the Performance Analysis settings that are set in the [Condition] list box. Clicking this button displays the [Performance <i>n</i>] dialog box. (<i>n</i> : number)
[Delete]	Cancels the Performance Analysis settings that are set in the [Condition] list box.
[Del All]	Cancels settings of all the subroutines set in the [Condition] list box.

Select 1 in the [Condition] list then press the [Edit...] button.

The following explains the [Performance Analysis Properties] dialog box.

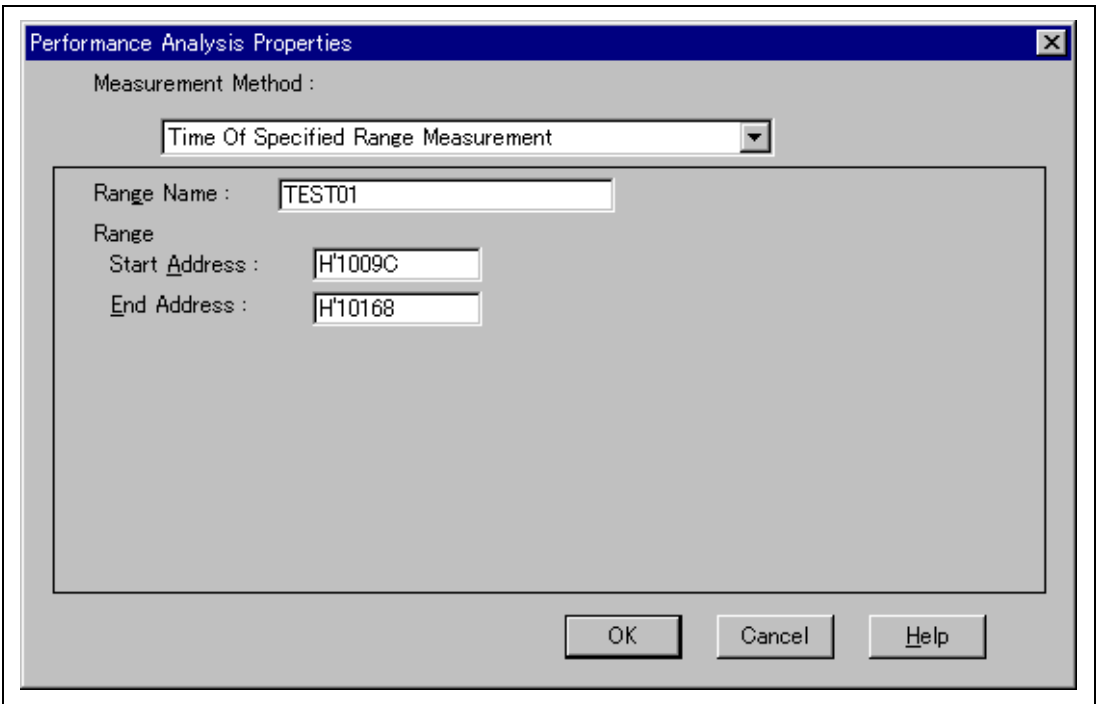

Figure 5.63 [Performance Analysis Properties] Dialog Box

The conditions on execution efficiency are set in this dialog box. These conditions have five modes (Measurement Methods). Set the address detection mode to the prefetch address detection mode in the Access Count Of Specified Range Measurement mode, and to the PC address detection mode in other modes.

Table 5.50 shows a list of five modes (Measurement Method).

Table 5.50 Setting Value for Measurement Method

Mode	Description		
Time Of Specified Range Measurement	Range Name	Specifies the range name.	
	Range	Specifies the range for Time Of Specified Range Measurement.	
	Start Address	Specifies the start address.	
	End Address	Specifies the end address.	
Start Point To End Point Measurement	Range Name	Specifies the range name.	
	Point	Specifies the range for Start Point To End Point Measurement.	
	Start Address	Specifies the start address.	
	End Address	Specifies the end address.	
	Time Out Action		Specifies the operation when a timeout for the execution time measurement or counting out occurs.
		Disable	Disables setting of a timeout value for the execution time measurement or a counted-out value.
		Break	Stops user program when a timeout for the execution time measurement or counting out occurs.
	Time Out	Trace Stop	Stops trace acquisition when a timeout for the execution time measurement or counting out occurs.
			To specify the minimum unit of the measurement time as 52 us, 1.6 us, and 20 ns, input h (hour), min (minute), s (second), ms (millisecond), us (microsecond), and ns (nanosecond); e.g., 1h 2min 3s 123ms 456us 789ns. A target clock is specified with six digits in hexadecimal; e.g., 123456. A break occurs when each measurement value between the start and end addresses exceeds the timeout value (not the total time).
	Count		Specifies a counted-up value for measuring the execution count.

Table 5.50 Setting Value for Measurement Method (cont)

Mode	Description		
Start Range To End Range Measurement	Range Name	Specifies the range name.	
	Start Range	Specifies the start range for Start Range To End Range Measurement.	
		Start Address	Specifies the start address.
		End Address	Specifies the end address.
	End Range	Specifies the end range for Start Range To End Range Measurement.	
		Start Address	Specifies the start address.
		End Address	Specifies the end address.
	Access Count Of Specified Range Measurement	Range Name	Specifies the range name.
Range		Specifies the start range for Access Count Of Specified Range Measurement.	
		Start Address	Specifies the start address.
		End Address	Specifies the end address.
Access Area Range		Specifies the end range for Access Count Of Specified Range Measurement.	
		Start Address	Specifies the start address.
		End Address	Specifies the end address.
Access Type		Selects the bus cycle in the access area.	
		Don't Care	All accesses
		DMAC	DMAC cycle
		CPU Prefetch	CPU prefetch cycle
	CPU Data	CPU data cycle	
Called Count Of Specified Range Measurement	Range Name	Specifies the range name.	
	Range	Specifies the start range for Called Count Of Specified Range Measurement.	
		Start Address	Specifies the start address.
		End Address	Specifies the end address.
	Call Range	Specifies the end range for Called Count Of Specified Range Measurement.	
		Start Address	Specifies the start address.
		End Address	Specifies the end address.

Displaying the Results of Performance Measurement: The results of performance measurement are displayed in the [Performance Analysis] window. To display the results, click the right-hand mouse button with the cursor in the [Performance Analysis] window then select a menu item from the pop-up menu. The menu items are shown in table 5.51.

Table 5.51 Menu Items for Displaying the Results

Menu Item	Description
[Value]	Displays the execution time and count (default).
[Graph]	Displays the proportions of execution time to the whole period of execution on a graph.

[Value]: Select [Value] to display the executed results with a numeric as shown in figure 5.64.

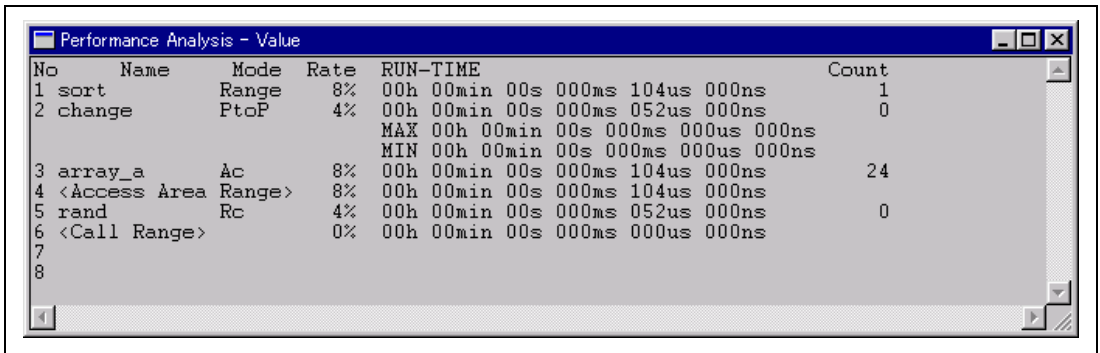

Figure 5.64 [Performance Analysis] Window ([Value] Selected)

Table 5.52 Display Format of Results When [Value] is Selected

Item	Contents
[NO]	Channel number.
[NAME]	Subroutine name.
[MODE]	Measurement mode. Range: Time Of Specified Range Measurement PtoP: Start Point To End Point Measurement RtoR: Start Range To End Range Measurement Ac: Access Count Of Specified Range Measurement Sc: Called Count Of Specified Range Measurement
[Rate]	Proportions of execution times. (numerical)
[RUN-TIME]	Total period of execution (h: hours, min: minutes, s: seconds, us: microseconds, ns: nanoseconds).
[Count]	Access count.

[Graph]: Select [Graph] to display the proportion of total execution time of the user program, as shown in figure 5.65.

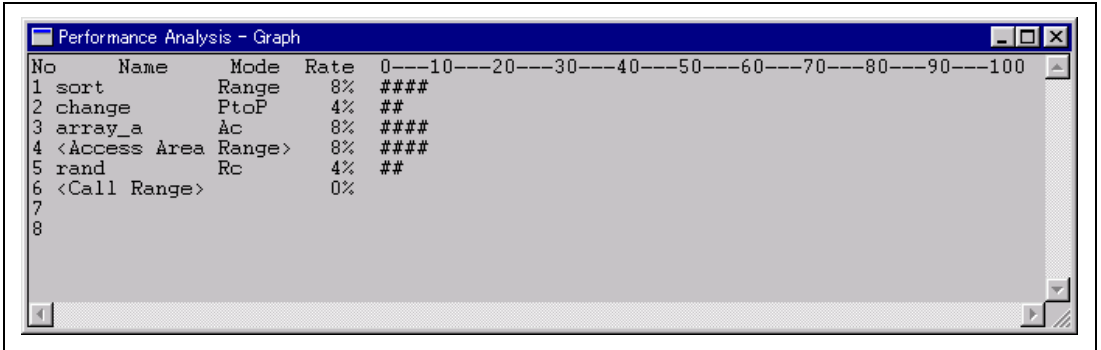

Figure 5.65 [Performance Analysis] Window (Results of Execution Time Ratios)

Table 5.53 Display Format of Results When [Graph] is Selected

Item	Contents
[NO]	Channel number.
[NAME]	Subroutine name.
[MODE]	Measurement mode. Range: Time Of Specified Range Measurement PtoP: Start Point To End Point Measurement RtoR: Start Range To End Range Measurement Ac: Access Count Of Specified Range Measurement Sc: Called Count Of Specified Range Measurement
[RATE]	Proportions of execution time (as numerical values and on a graph).

Initializing Performance Measurement Information: To initialize performance measurement information, select [Refresh] from the pop-up menu of the [Performance Analysis] window. Before the initialization, the emulator will display a message box to ask you if you want to initialize the information. To initialize the information, press the [Yes] button.

5.9.2 Profiling Function

Profiling Data Measurement Function: This function is used to collect and measure the elapsed time in each function. Program execution and suspension are repeated and a difference will be included.

In the HDI, three windows shown in table 5.54 are provided. For details, refer to the Hitachi Debugging Interface User's Manual on the CD-R.

Table 5.54 Window Provided by the Profiling Data Measurement Function

Window	Contents
[Profile-List]	Displays the address, size, the number of calls, and execution time of a function by selecting [Profile-List] from the [View] menu.
[Profile-Tree]	Displays the relationship of calling functions with a tree structure. In addition, the address, size, stack size, the number of calls, and execution time of a function are displayed. The value of the stack size, the number of calls, and execution time of a function are included in the actual path of calling a function. These items are displayed by selecting [Profile-Tree] from the [View] menu.
[Profile-Chart]	Displays the relationship of calling functions focusing a certain function. This window opens from the [Profile-List] or [Profile-Tree] window. When a certain function is selected and the right-hand mouse button is clicked in the [Profile-List] or [Profile-Tree] window, a pop-up menu is displayed. When [View Profile-Chart] is selected from the pop-up menu, the relationship of calling functions, selected on the [Profile-Chart] window, is displayed. The focused function is displayed at center, the calling source function at left, and calling destination function at right. The value by the side of the calling source and calling destination functions are the number of calls.

- Measuring the Profiling Data
 - Downloading the load module
Download the ELF/DWARF2-type load module.
 - Switching the profiling data measurement function
To enable collecting the profiling data, select [Enable Profiler] from the pop-up menu in the window (any shown in table 5.54) and click the left of a text. To disable collecting the profiling data, select [Enable Profiler] again and remove the mark at the left of the text.
 - [Profile-List] window
The address ([Address] cell), size ([Size] cell), the number of calls ([Times] cell), and execution time of a function are displayed. The following shows an example after the user program has been executed.

Function/Variable	Address	Size	Times	Run Time
_main	H'00001034	H'0000006C	0	0
_strpbrk	H'000013FC	H'00000078	0	0
_strtok	H'00001318	H'000000E4	0	0
_srand	H'00001304	H'00000014	0	0
_rand	H'000012D0	H'00000034	0	0
_Dummy	H'000012C8	H'00000006	0	0
_INT_HUDI	H'000012C2	H'00000006	0	0
_INT_FPU	H'000012BC	H'00000006	0	0
_INT_User_Break	H'000012B6	H'00000006	0	0
_INT_NMI	H'000012B0	H'00000006	0	0
_INT_DMAC_Address	H'000012AA	H'00000006	0	0
_INT_CPU_Address	H'000012A4	H'00000006	0	0
_INT_Illegal_slot	H'0000129E	H'00000006	0	0
_INT_Illegal_code	H'00001298	H'00000006	0	0
_INITSCT	H'0000122C	H'0000006C	0	0
_sbrk	H'000011EC	H'00000040	0	0
_INIT_OTHERLIB	H'000011CC	H'00000020	0	0
_INITLIB	H'000011C0	H'0000000C	0	0
_change	H'0000115E	H'00000062	0	0
_sort	H'000010A0	H'000000BE	0	0

Figure 5.66 [Profile-List] Window

- Notes: 1. If there is no information file for the amount of stack used (extension is '.sni') that is output from the optimizing linkage editor, only the function, that has been executed at measuring the profiling data, is displayed. For details, refer to the manual of the optimizing linkage editor.
2. The [Select Data] in the pop-up menu is invalid.

— [Profile-Tree] window

The address ([Address] cell), size ([Size] cell), stack size ([Stack Size] cell), the number of calls ([Times] cell), and execution time of a function are displayed. The following shows an example after the user program has been executed.

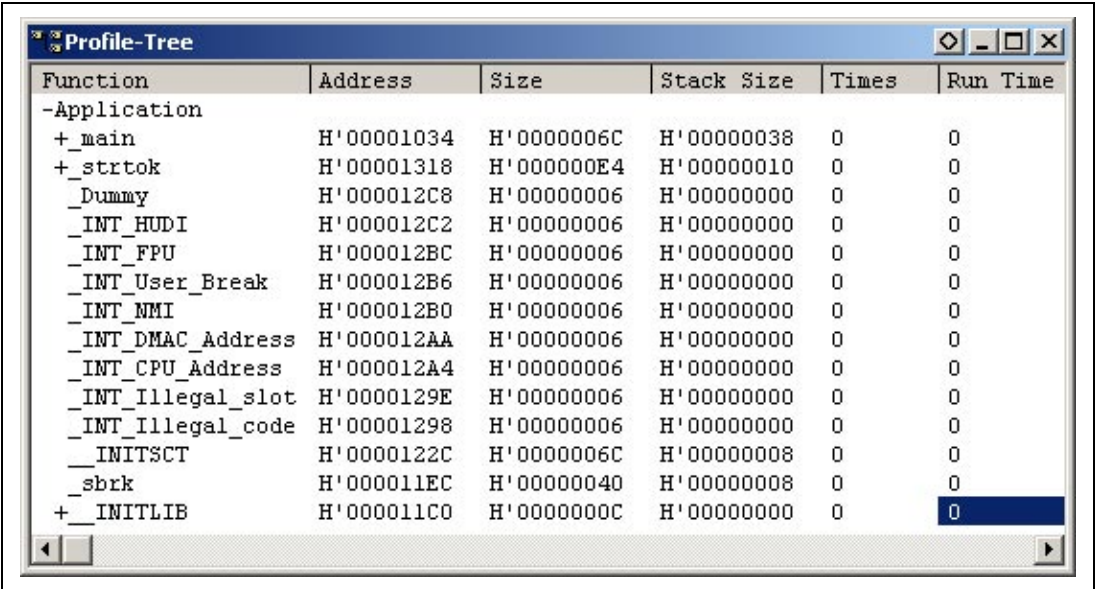

The screenshot shows a window titled "Profile-Tree" with a table of function execution statistics. The table has six columns: Function, Address, Size, Stack Size, Times, and Run Time. The data is as follows:

Function	Address	Size	Stack Size	Times	Run Time
-Application					
+_main	H'00001034	H'0000006C	H'00000038	0	0
+_strtok	H'00001318	H'000000E4	H'00000010	0	0
_Dummy	H'000012C8	H'00000006	H'00000000	0	0
_INT_HUDI	H'000012C2	H'00000006	H'00000000	0	0
_INT_FPU	H'000012BC	H'00000006	H'00000000	0	0
_INT_User_Break	H'000012B6	H'00000006	H'00000000	0	0
_INT_NMI	H'000012B0	H'00000006	H'00000000	0	0
_INT_DMxAC_Address	H'000012AA	H'00000006	H'00000000	0	0
_INT_CPU_Address	H'000012A4	H'00000006	H'00000000	0	0
_INT_Illegal_slot	H'0000129E	H'00000006	H'00000000	0	0
_INT_Illegal_code	H'00001298	H'00000006	H'00000000	0	0
_INTSCT	H'0000122C	H'0000006C	H'00000008	0	0
_sbrk	H'000011EC	H'00000040	H'00000008	0	0
+__INITLIB	H'000011C0	H'0000000C	H'00000000	0	0

Figure 5.67 [Profile-Tree] Window

Note: The stack size differs from the actual value. It should be the target in the actual path of calling a function. If there is no information file for the amount of stack used (extension is '.sni') that is output from the optimizing linkage editor, the stack size is not displayed.

— [Profile-Chart] window

The relationship of calling functions, selected on the [Profile-List] or [Profile-Tree] window, is displayed. The focused function is displayed at center, the calling source function at left, and calling destination function at right. The value by the side of the calling source and calling destination functions are the number of calls.

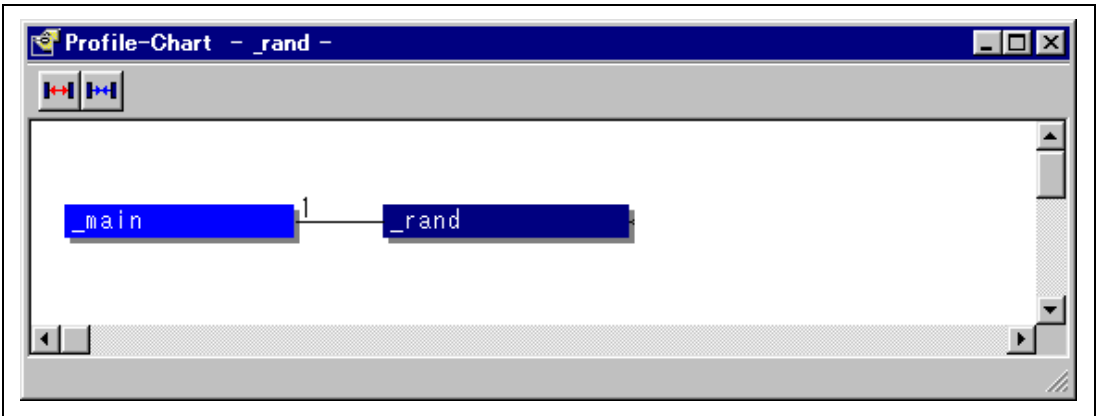

Figure 5.68 [Profile-Chart] Window (after User Program Execution)

— Setting the condition for starting or ending the profiling data measurement

The measurement period of the profiling data is from the start to end of the user program execution. The following shows the conditions for starting or ending the profiling data measurement.

Table 5.55 Conditions for Starting or Ending the Profiling Data Measurement

Condition	Contents	Setting
Start	Current PC (program counter)	<ul style="list-style-type: none"> • [Go] from the [Run] menu ([Go] button on the toolbar) • Specifies the start address in [Set PC To Cursor] from the [Run] menu
	Reset vector address	<ul style="list-style-type: none"> • [Reset Go] from the [Run] menu ([Reset Go] button on the toolbar)
End	On-emulator break	<ul style="list-style-type: none"> • Sets the [On Emulator Break] dialog box
	Stop address	<ul style="list-style-type: none"> • [Go To Cursor] from the [Run] menu ([Go To Cursor] button on the toolbar)
	Halt	<ul style="list-style-type: none"> • [Halt] from the [Run] menu ([Stop] button on the toolbar)

Note: As the end condition, the user program is halted when the break instruction is executed.

— Limitation on the profiling function

When the profiling function is enabled, there are limitations shown in table 5.56.

Table 5.56 Limitations on Enabled Profiling Function

Emulation State	Limitations
During user program execution	<ul style="list-style-type: none">• Settings on software break, on-emulator break, and on-chip break are ignored.*• The performance measurement condition is ignored.• The trace acquisition condition is ignored.• The setting of [When trace-buffer full] in the [Trace Acquisition Properties] dialog box ([Other] page) is ignored.• Accessing to memory is disabled (display or modify in the [Memory] or [Disassemble] window).• The displayed contents of the [Aum] window are not updated.

Note: Do not use the profiling function for the standby mode in the user program.

- Differences

The profile function internally breaks user program execution, collects the measured data, and re-executes the user program. Since the function also counts when the measured item is generated at break or re-execution, a difference will be included in the measured profile value.

It takes a long time to start and end the user program execution. The user program execution times under the following environment are shown below. The measured value of this function should be the target.

Environment:

Host computer: 400 MHz (Pentium® II)

Memory: 128 Mbytes

OS: Windows® 98

Execution program: 10,000 nested calls

- When the profile function is not used: 1 second or shorter
- When the profile function is used in the setting without including a callee function: 20 seconds
- When the profile function is used in the setting including a callee function: 400 seconds

5.10 Displaying Various Information

The [System Status] window displays a variety of information set by each dialog box. Open the [System Status] window by selecting [Status] from the [View] menu.

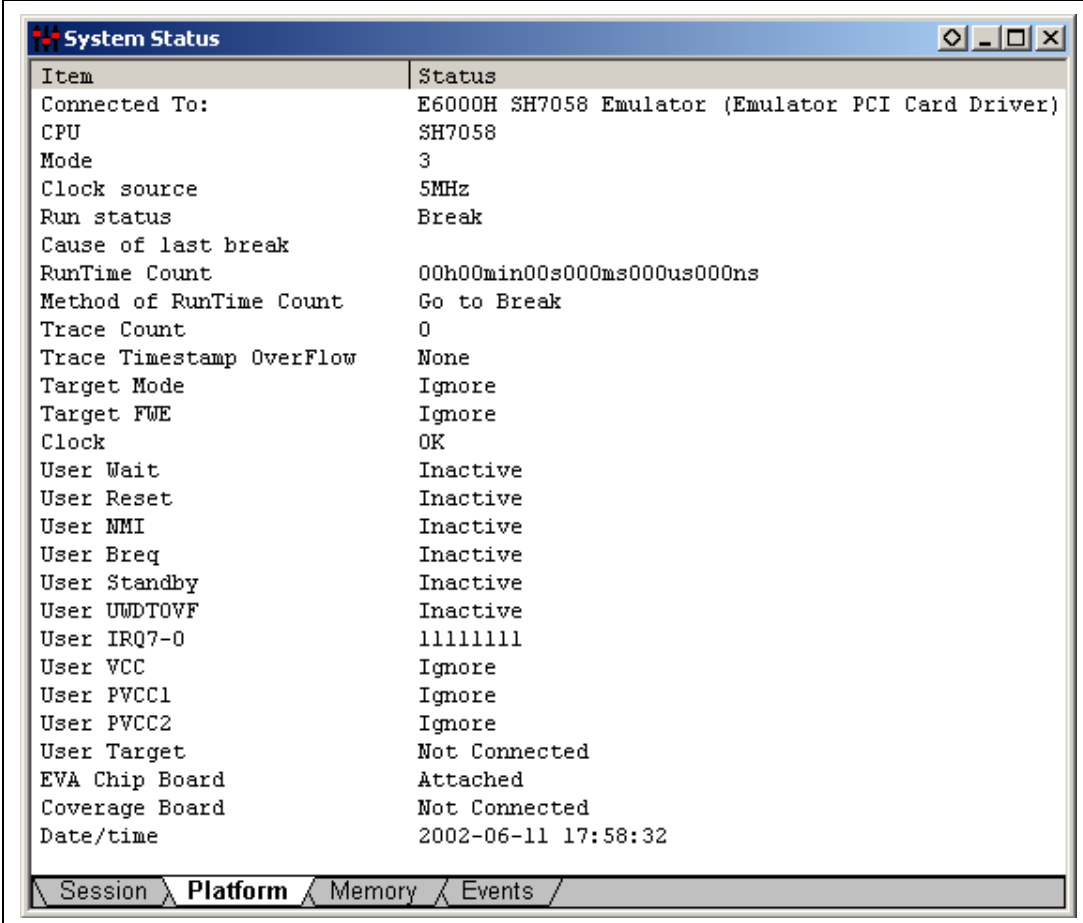

The screenshot shows a window titled "System Status" with a blue header bar and standard window controls. The main area contains a list of system parameters and their current status. At the bottom, there is a navigation bar with tabs for "Session", "Platform", "Memory", and "Events".

Item	Status
Connected To:	E6000H SH7058 Emulator (Emulator PCI Card Driver)
CPU	SH7058
Mode	3
Clock source	5MHz
Run status	Break
Cause of last break	
RunTime Count	00h00min00s000ms000us000ns
Method of RunTime Count	Go to Break
Trace Count	0
Trace Timestamp OverFlow	None
Target Mode	Ignore
Target FWE	Ignore
Clock	OK
User Wait	Inactive
User Reset	Inactive
User NMI	Inactive
User Breq	Inactive
User Standby	Inactive
User UWDTOVF	Inactive
User IRQ7-0	11111111
User VCC	Ignore
User PVCC1	Ignore
User PVCC2	Ignore
User Target	Not Connected
EVA Chip Board	Attached
Coverage Board	Not Connected
Date/time	2002-06-11 17:58:32

Figure 5.69 [System Status] Window

[System Status] window has the four sheets as shown in table 5.57.

Table 5.57 [System Status] Window Configuration

Sheet Name	Description
[Session]	Contains such information on the current session as whether a debugging platform is connected and the names of loaded files.
[Platform]	Includes the status information on the Emulator, such as the name of the connected emulator.
[Memory]	Includes the information related to the current state of memory, such as memory mapping and the memory areas to be used by loaded object files.
[Events]	Contains information on the usage of resources on breakpoints.

The [Session] sheet has the following contents.

Table 5.58 [Session] Sheet Configuration

Item	Description
[Target System]	Indicates whether the emulator is connected.
[Session Name]	A session file name.
[Program Name]	The name of a load module that is loaded.

The [Platform] sheet has the following contents.

Table 5.59 [Platform] Sheet Configuration

Item	Description
[Connected To:]	The name of an emulator that is connected.
[CPU]	The type of target MCU.
[Mode]	The mode that is selected.
[Clock source]	The clock that is selected.
[Run status]	Whether or not the user program is being executed.
[Cause of last break]	The cause of termination by a break.
[Run Time Count]	The results of measuring the program execution time.
[Trace Count]	The number of all traced results.
[Trace Timestamp OverFlow]	Whether or not the timestamp of the trace overflows.
[Target Mode]	The mode input from the user system.
[Target FWE]	Whether or not there is the FWE signal input from the user system.
[Clock]	Whether or not there is the clock to be input.
[User Wait]	The state of the WAIT pin.
[User Reset]	The state of the RES pin.
[User NMI]	The state of the NMI pin.
[User Breq]	The state of the BREQ pin.
[User Standby]	The state of the HSTBY pin.
[User UWDTOVF]	The state of the WDTOVF pin.
[User IRQ7-0]	The state of the IRQ7, IRQ6, IRQ5, IRQ4, IRQ3, IRQ2, IRQ1, and IRQ0 pins.
[User Vcc]	Whether or not the user Vcc is 2.6 V or more when the target system is connected.
[User PVcc1]	Whether or not the user PVcc1 voltage satisfies the value specified with User Vcc Threshold in the [Configure Platform] dialog box when the target system is connected.
[User PVcc2]	Whether or not the user PVcc2 is 4.2 V or more when the target system is connected.
[User Target]	Whether or not the user target system has been connected at activation.
[EV Chip Board]	Whether or not the evaluation chip board has been connected at activation.
[Coverage Board]	Whether or not the optional coverage board has been connected at activation.
[Date/time]	Current date and time.

The [Memory] sheet has the following contents.

Table 5.60 [Memory] Sheet Configuration

Item	Description
[Target Device Configuration]	The memory-map status of the on-chip module (INTERNAL I/O).
[System Memory Resources]	The remaining capacity of the emulation memory.
[Load Memory Areas]	The address range of the load module that was loaded.

The [Events] sheet has the following content.

Table 5.61 [Events] Sheet Configuration

Item	Description
[Resources]	The number of effective breakpoints that have been set.

5.11 Trigger Output

During execution of the user program, the emulator outputs a low-level pulse from the trigger-output probe under the following two conditions.

- Trace condition satisfaction
- Hardware break condition satisfaction

Using this pulse as an oscilloscope's trigger input signal makes it easy to adjust the user system hardware. For example, the waveform produced when the user program goes to a specified point can be viewed.

When the trigger output is specified by using of the [User Signals] option of the [General] page in the [Configuration] dialog box, a low-level pulse is output for two bus cycles from the trigger output pin after 10 bus cycles in which hardware break and hardware break conditions were satisfied during emulation. The pulse is output until the end of the subsequent bus cycle. If the conditions are satisfied over consecutive bus cycles, the trigger output remains low. When the on-chip ROM/RAM is accessed, the timing of pulse output will be as shown in figure 5.70.

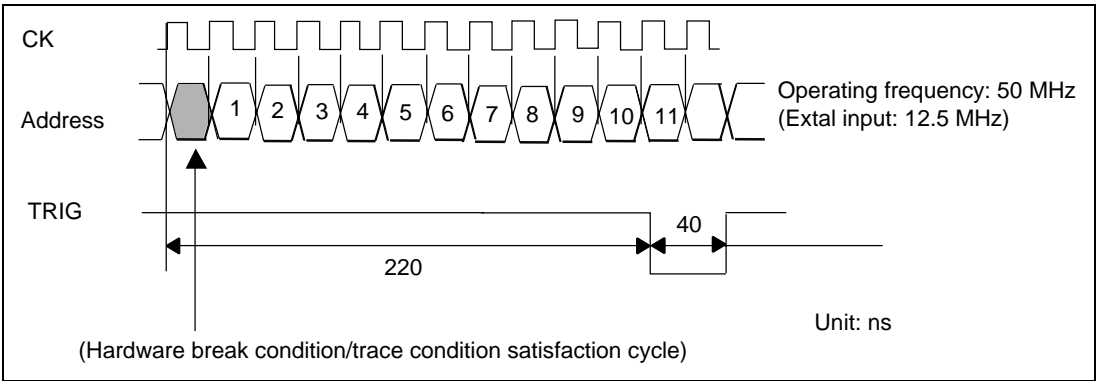

Figure 5.70 Pulse Output Timing

Note: No pulse is output from the trigger-output probe when a software break condition is satisfied. In addition, the timing of the pulse output and the pulse width differ according to the condition.

5.12 Stack Trace Function

The stack trace function displays the history of function calls. In the stack trace function, contents of memory are displayed in the [Stack Trace] window. The [Stack Trace] window can be displayed by selecting [Stack Trace] from the [View] menu.

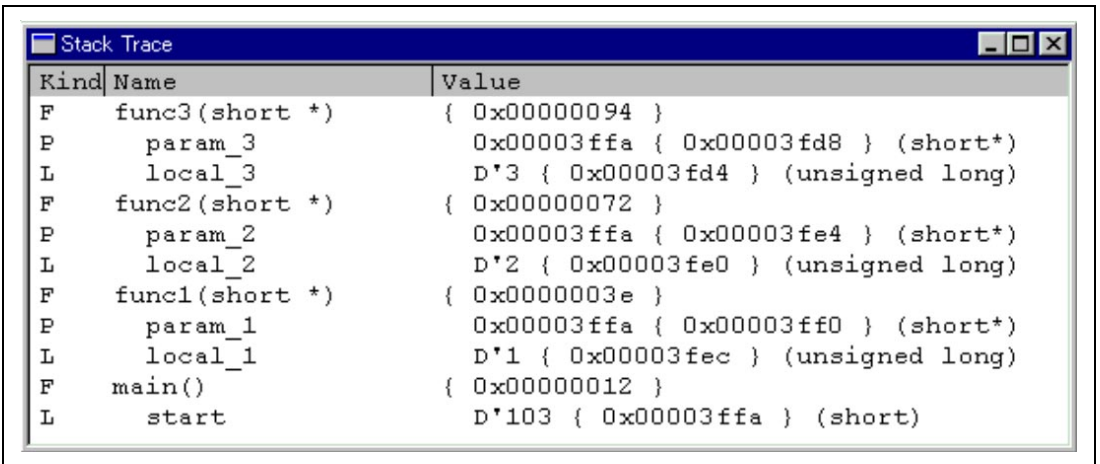

Figure 5.71 [Stack Trace] Window

Table 5.62 [Stack Trace] Window Options

Option	Description
[Kind]	Symbol type F: Function, P: Function parameter, L: Local variable
[Name]	Symbol name
[Value]	Symbol value, address, and type

Click the right-hand mouse button with the cursor in the [Stack Trace] window. The pop-up menu will be displayed. The menu includes the following options.

Table 5.63 Options in the Pop-up Menu

Option	Description
[Copy]	Copies the highlighted text to the Windows® clipboard so that the text can be pasted to other applications.
[Go to Source]	Displays the source code in the program that corresponds to the selected function in the [Source] window.
[View Setting...]	Opens the [Stack Trace Setting] dialog box and sets the display format of the [Stack Trace] window.

The format of the [Stack Trace Setting] dialog box is displayed in figure 5.72.

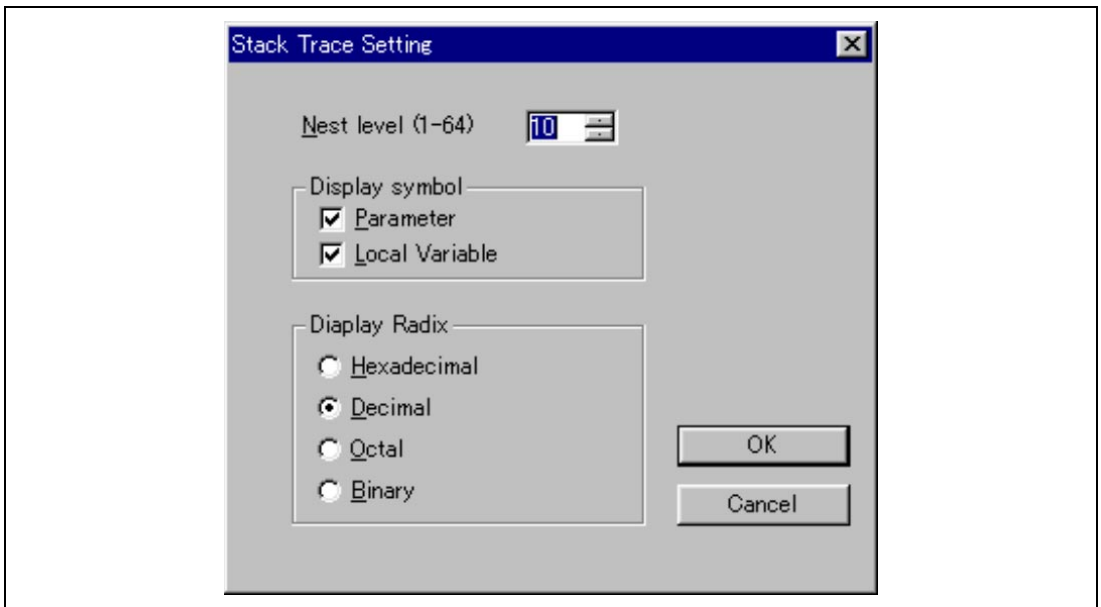

Figure 5.72 [Stack Trace Setting] Dialog Box

Table 5.64 [Stack Trace Setting] Dialog Box Options

Option	Description
[Nest level]	Specifies the number of function call nestings for display in the [Stack Trace] window. Max: 64
[Display symbol]	Specifies symbols other than functions for display. Specifies whether parameters and local variables will be displayed.
[Display Radix]	Specifies the radix for the display in the [Stack Trace] window.

To refer to the online help system, press the [F1] key after moving the cursor to the [Stack Trace] window.

5.13 Displaying and Updating the Contents of Memory

5.13.1 Displaying and Updating the Contents of Memory during Execution

The emulator accesses memory in three ways to display and update the contents of memory during user program execution.

Table 5.65 Access Types for Displaying and Modifying Contents of Memory

Access Type	Description	Stop Time	Display	Modification
Parallel access	Temporarily halts the execution of the user program	Short	Enabled	Enabled
Auto update Memory	Automatically updates the display of the contents of memory without stopping the execution of the user program	None	Enabled	Disabled

Note: For details on stopped periods and other notes, refer to appendix E.7, Displaying and Modifying the Contents of Memory.

The respective access types have the following characteristics.

Table 5.66 Characteristics of Displaying and Modifying Contents of Memory

Access Type	Target Window/Command Line	Target Memory Area
Parallel access	Windows other than the [Auto update Memory] window that display memory contents Commands to display or modify memory contents	Memory, on-chip I/O area, on-chip RAM, or on-chip ROM Emulation memory
Auto update Memory	[Auto update Memory] window No target command	Specified address range

The memory refresh function of the HDI ([Memory] or-[Refresh] menu) updates the contents of windows (other than [Auto update Memory]) that display the contents of memory. Therefore, if the memory refresh function is used during execution of the user program, parallel access will occur if the [I/O Registers] window, or the [Memory] window that displays the contents of on-chip RAM is opened.

5.13.2 Overview of Auto-Update Memory Function

In an auto-update of memory, the display of the contents of the specified area of memory is refreshed at intervals of 500 ms while the user program is being executed. The function has the following features:

Automatically updates, with an interval of approximately 500 ms, the display of the specified memory contents while the user program is being executed.

A color may be applied to indicate the contents that have been modified since the last update of the display.

Allows the setting of a maximum of 8 points (auto-update memory items), each running for a maximum of 32 bytes.

Allows the display of memory contents in ASCII, bit, byte, word, longword, or single-precision floating point formats (with or without a sign, and in decimal or hexadecimal).

The following dialog boxes are used to set items for the auto-update memory function.

Table 5.67 Dialog Boxes for Setting Auto-Update Memory Items

Dialog Box	Description
[Auto-update Memory -Add-]	Dialog box for registering items for the auto-update memory function. Select the address, format of display, and number of bytes of memory to be displayed.
[AUM – Target Details]	Dialog box for registering other settings for auto-update memory items. In particular, those conditions that depend on the target MCU are set here.

In an auto-update of memory, the contents of the specified area of memory are displayed in the [AUM] window. The [AUM] window is displayed by selecting [Auto update Memory Window] from the [View] menu and registering the Auto update Memory item in the [Auto-update Memory -Add-] dialog box.

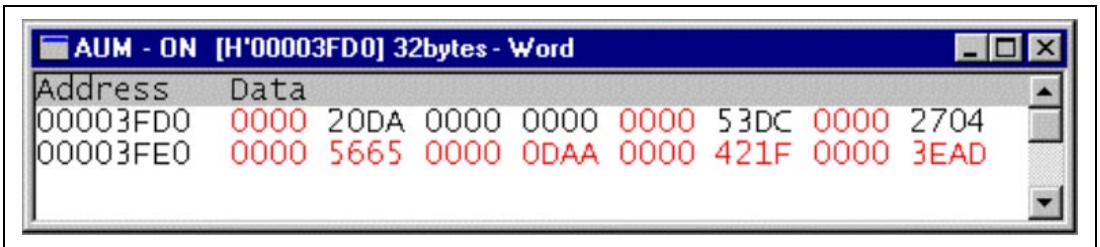

Figure 5.73 [AUM] Window

The [AUM] window displays the selected ranges of memory, and this display is refreshed while the user program is being executed. Up to 8 windows (8 points) can be displayed in the [AUM] window.

5.13.3 Setting Auto update Memory

Points to Be Set And Byte Size to Acquire: Up to 8 points can be set. Up to 32 bytes can be acquired from each point.

5.13.4 Displaying the Auto update Memory

Display format: The auto-update memory function allows the display of memory contents in ASCII, bit, byte, word, longword, single-precision floating point units, or double-precision floating point units (with or without signs, in decimal or hexadecimal).

Click the right-hand mouse button with the cursor in the [AUM] window. The pop-up menu will be displayed. Select [Edit...] from the menu to display the [Auto-update Memory -Edit-] dialog box and select [Format] from the [Auto-update Memory -Edit-] dialog box to change the display

format, or select [Format] from the pop-up menu of the [AUM] window to change the display format.

Display Color: A color is applied to indicate the contents that have been modified since the last update of the display. Select [Type] from the [Color] group box in the [Auto-update Memory - Edit-] dialog box.

When [Change] is selected as [Type], modified data will be displayed in color. It is also possible to specify the foreground and background colors of the window. If [Gray] is selected, the modified data will be displayed in the color, with the unchanged data displayed in gray. When [Mayfly] is selected, the color is changed every time the contents of the window are updated.

To set the display format and display color, use the [Auto-update Memory -Edit-] dialog box. After setting the required items, click the [OK] button.

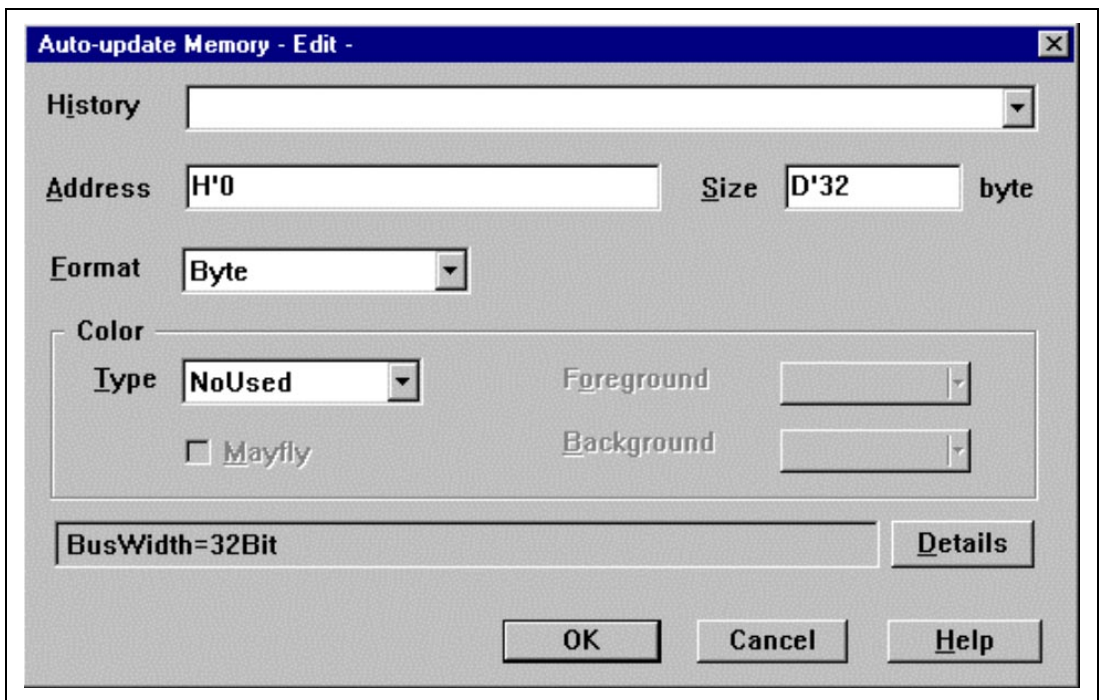

Figure 5.74 [Auto-update Memory -Edit-] Dialog Box

Note: In the situations listed below, the user program will not be executed in realtime.

When an auto-update memory item is set or modified while the user program is being executed.

When [Format] is modified while the user program is being executed.

5.14 Input Format

5.14.1 Entering Masks

Address bus conditions and data bus conditions can be input with masks. Addresses can be masked in 1-, 3-, or 4-bit units. When a bit is masked, it always satisfies the condition.

To specify a mask for an address bus condition, specify the mask value in the [Mask] area.

The mask for data conditions is similarly specified in the [Mask] area.

To specify any further mask, specify 1 for the digits to be ignored. Examples of mask specification is shown below.

Table 5.68 Address Mask Specification

No	Input Value	Mask Unit	Example	Masked Bits
1	Binary	1 bit	B'0000111	Masks bits 0 to 2
2	Octal	3 bits	O'000017	Masks bits 0 to 3
3	Hexadecimal	4 bits	H'07FF	Masks bits 0 to 10

5.15 [Source] Window Expanded Function

5.15.1 Setting BP Column

In the HDI, PC (program counter) break can be set, cancelled, or displayed in the BP column of the [Source] window.

PC break can be set or cancelled by selecting a PC breakpoint with the left-hand mouse button and double-clicking in the BP column or by placing the cursor at the line where the breakpoint was set and pressing the F9 key.

This function is the same as for the BP columns in the [Disassembly] and [Labels] windows.

PC break, set on the window, firstly occupies channel 12 of On Chip Break, then subsequently uses channels 11, 10, ..., 3, 2, and 1.

Section 6 Command Line

6.1 List Format

This section explains the format for the command list in section 6.2. Some commands are explained on a single page. Some commands are explained over several pages.

6.1.1 Description

The entries are in the following format:

Command name (abbreviation)

[Command syntax and parameters]

Shows input format for each command.

[Description]

Describes the usage and function of each command.

[Examples]

Example of usage.

[Notes]

Notes on using the command. Some entries have no notes.

6.1.2 Format

Symbols used in the command format have the following meanings:

- <>: Contents of <> are parameters.
- []: Parameters enclosed by [] can be omitted.
- <>=: The parameter shown in the left <> can be expressed in the format in the right <>.
- |: One or both can be selected, non-exclusively.
- | |: Either of two or one can be selected, exclusively.

The parameters of each command are explained in the tables in section 6.2.

6.1.3 Parameter Type Input

1. Numerical parameters

Numerical parameters must be supplied as binary, octal, decimal, or hexadecimal numbers, symbols, or expressions. A symbol can consist of up to 32 characters. Operators (e.g.: + and -) can be used to delimit expressions.

2. Keyword parameters

The bold-faced characters in the tables for each command are the strings that are input as keyword parameters.

Only the listed strings can be used. If a string that is not listed is input, an error will occur.

3. String parameters

String parameters are used to input mask data, symbols, and file names. When using strings to mask data, specify H' (hexadecimal), O' (octal), or B' (binary) at the head of the data as the radix. Specify 1 for the bits that correspond to the digits to be masked. When a bit is masked, it always satisfies the condition.

No	Input Value	Mask Unit	Example	Masked Bits
1	Binary	1 bit	B'00000111	Masks bits 0 to 2
2	Octal	3 bits	O'000017	Masks bits 0 to 3
3	Hexadecimal	4 bits	H'07FF	Masks bits 0 to 10

6.1.4 Examples

The examples show how to input the command. When output results, the output is also described.

6.2 List of Commands

The following is a list of HDI emulation commands. Sections in this manual are indicated in the second column. If there is no section number, the description is in the Hitachi Debugging Interface User's Manual provided on the CD-R.

Table 6.1 List of Commands

Command	Section	Abbreviation	Description
!	—	—	Comment
ASSEMBLE	—	AS	Assembles user program.
ASSERT	—	—	Checks the condition.
ANALYSIS	6.2.1	AN	Displays the result of measurement for the rate of time spent.
ANALYSIS_RANGE n	6.2.2	AR n	Sets the conditions for measuring the rate of time spent.
ANALYSIS_RANGE_DELETE	6.2.3	AD n	Specifies or clears all the conditions for measuring the rate of time spent.
BREAKPOINT_ONCHIP	6.2.4	BC	Sets on-chip breakpoints.
BREAKPOINT_ONCHIP n	6.2.4	BC n	Sets on-chip breakpoints for each channel.
BREAKPOINT_ONCHIP_CLEAR	6.2.4	BCC	Clears on-chip breakpoints.
BREAKPOINT_ONCHIP_ENABLE	6.2.4	BCE	Enables or disables on-chip breakpoints that have been set.
BREAKPOINT_ONCHIP_RESET	6.2.4	BCR	Sets a reset point for on-chip breakpoints.
BREAKPOINT_ONEMULATOR	6.2.5	BE	Sets on-emulator breaks.
BREAKPOINT_ONEMULATOR n	6.2.5	BE n	Sets on-emulator breaks for each channel.
BREAKPOINT_ONEMULATOR_CLEAR	6.2.5	BEC	Clears the on-emulator breakpoints that have been set.
BREAKPOINT_ONEMULATOR_ENABLE	6.2.5	BEE	Enables or disables the on-emulator breakpoints that have been set.
BREAKPOINT_SOFTWARE	6.2.6	BS	Sets software breakpoints.
BREAKPOINT_SOFTWARE_CLEAR	6.2.6	BSC	Clears software breakpoints that have been set.

Table 6.1 List of Commands (cont)

Command	Section	Abbreviation	Description
BREAKPOINT_SOFTWARE_ENABLE	6.2.6	BSE	Enables or disables software breakpoints that have been set.
CLOCK	6.2.7	CK	Sets and displays the CLOCK signal for the MCU.
CONFIGURATION_PLATFORM	6.2.8	CP	Sets the operating conditions for the emulator.
DEVICE_TYPE	6.2.9	DE	Displays the type of a currently selected MCU.
DISASSEMBLE	—	DA	Disassembles user program and displays the result.
ERAM	6.2.10	EM	Sets the emulation memory or displays the contents.
ERASE	—	ER	Clears the contents of the Command Line window.
EVALUATE	—	EV	Calculates an expression.
FILE_LOAD	—	FL	Loads an object (program) file.
FILE_SAVE	—	FS	Saves the contents of memory as a file.
FILE_VERIFY	—	FV	Compares the contents of a file with memory.
FLASH_MEMORY	6.2.11	FM	Erases the contents of the flash memory.
GO	—	GO	Executes the user program.
GO_RESET	—	GR	Executes the user program from the reset vector.
GO_TILL	—	GT	Executes the user program up to a temporary breakpoint.
HALT	—	HA	Halts the user program.
HELP	—	HE	Displays help for command lines and commands.
INITIALISE	—	IN	Initializes a platform.
LOG	—	LO	Manipulates logging file.
MAP_DISPLAY	6.2.12	MA	Displays memory map information.
MEMORY_DISPLAY	—	MD	Displays memory contents.
MEMORY_EDIT	—	ME	Modifies memory contents.

Table 6.1 List of Commands (cont)

Command	Section	Abbreviation	Description
MEMORY_FILL	—	MF	Fills the memory with the specified data.
MODE	6.2.13	MO	Sets or displays the MCU mode.
MEMORY_MOVE	—	MV	Moves memory blocks.
MEMORY_TEST	—	MT	Tests memory blocks.
QUIT	—	QU	Terminates HDI.
RADIX	—	RA	Sets an input radix.
REFRESH	6.2.14	RF	Updates the memory information in HDI to reflect the latest state.
REGISTER_DISPLAY	—	RD	Displays MCU register values.
REGISTER_SET	—	RS	Sets MCU register values.
RESET	—	RE	Resets the MCU.
SLEEP	—	—	Delays command execution.
STEP	—	ST	Executes in steps (specified as instruction units or source line units).
STEP_OUT	—	SP	Executes until the function represented by the address at the program counter has finished.
STEP_OVER	—	SO	Steps over function.
STEP_RATE	—	SR	Sets and displays step execution rate.
SUBMIT	—	SU	Executes emulation command file.
SYMBOL_ADD	—	SA	Sets symbol.
SYMBOL_CLEAR	—	SC	Deletes symbol.
SYMBOL_LOAD	—	SL	Loads symbol information file.
SYMBOL_SAVE	—	SS	Saves symbol information file.
SYMBOL_VIEW	—	SV	Displays symbol.
TEST_EMULATOR	6.2.15	TE	Tests the on-chip flash memory area.
TIMER	6.2.16	TI	Displays or modifies the minimum for measurement of time.
TRACE_ACQUISITION	6.2.17	TA	Sets conditions for acquiring trace information.
TRACE_ACQUISITION n	6.2.17	TA n	Makes settings for each channel for acquiring trace information.
TRACE_ACQUISITION_CLEAR	6.2.17	TAC	Clears trace conditions that have been set.

Table 6.1 List of Commands (cont)

Command	Section	Abbreviation	Description
TRACE_COMPARE	6.2.18	TC	Compares the current trace data and the trace file that has been saved (refer to the trace_save section).
TRACE_SAVE	6.2.19	TV	Saves trace data as a file in the text format.
TRACE_SEARCH	6.2.20	TS	Sets conditions for displaying trace data.
USER_SIGNALS	6.2.21	US	Sets or displays user signals.

6.2.1 ANALYSIS (AN)

[Command syntax and parameters]

- Display **an** [<v>]

Parameter	Type	Description
<v>	Keyword	Displays the result that it has measured the rate of time spent during the last program run. Default: Displays the rate of time spent during the last program run as percentages and histogram. v: Displays the rate of time spent during the last program run as percentages, amount of time spent and the execution count.

[Description]

Displays the result that it has measured of the rate of time spent during the last program run.

[Examples]

1. To display the result as percentages, amount of time spent and the execution count:

an v

2. To display the result as percentages and histogram:

an

6.2.2 ANALYSIS RANGE n (AR n)

Sets the conditions of the rate of time spent during the last program run, the address detection mode and the shortest measure clock. There are five measurement methods.

- The Time Of Specified Range Measurement
- The Start Point To End Point Measurement
- The Start Range To End Range Measurement
- The Access Count Of Specified Range Measurement
- The Called Count Of Specified Range Measurement

It is possible to set the condition on all points by The Time Of Specified Range Measurement / The Start Point To End Point Measurement. The condition on 1, 3, 5, 7 point can be set by the other methods.

The command syntax and parameters of each condition of the rate of time spent are listed below.

(1) The Time Of Specified Range Measurement

[Command syntax and parameters]

- Setting **AR n Range** <Name> <StartAddress> <EndAddress>

Parameter	Type	Description
n	Numeric	Sets a channel number from 1 to 8.
Range	Keyword	Makes settings for measurement of time in the specified range.
<Name>	Keyword	Specifies the name of the range.
<StartAddress>	Numeric	Specifies a start address.
<EndAddress>	Numeric	Specifies an end address.

[Description]

This command measures time in the specified range.

[Example]

To set a condition of the rate of time spent in the specified range from the address H'100 to H'200:

```
ar1 Range RAM H'100 H'200
```

(2) The Start Point To End Point Measurement

[Command syntax and parameters]

- Setting **AR***n* **PtoP** <Name> <StartAddress> <EndAddress> [**action** <action>]
[**time** <time>] [**count** <Count>]

Parameter	Type	Description
<i>n</i>	Numeric	Sets a channel number from 1 to 8.
PtoP	Keyword	Makes settings for measurement of time between the specified addresses PtoP.
<Name>	Keyword	Specifies the name of the range.
<StartAddress>	Numeric	Specifies a start address.
<EndAddress>	Numeric	Specifies an end address.
[action <action>]	Keyword	Operation when a timeout or count-out occurs to finish measurement. Only point 1 can be specified. <action> = <disable Break tracestop> disable : Does not specify operation at an occurrence of timeout or count-out. Break : Breaks when a timeout or count-out occurs. tracestop : Stops tracing when a timeout or count-out occurs.
[time <time>]	Numeric	The time-out value to finish measurement. Specification: time <time> <time> specifies the time in the following forms; h: Hours min: Minutes s: Seconds ms: Milliseconds us: Microseconds ns: Nanoseconds (e.g. time 1h 2 min 3 s 123 ms 456 us 789 ns) The target clock can be specified as hexadecimals in 10 digits (e.g. time H'123456789A).
[count <count>]	Numeric	The count-up value to measure. Specification: count <count> The number can be specified in the range from H'1 to H'FFFF.

[Description]

This command measures time between the specified addresses.

[Example]

To set a condition of the rate of time spent between the addresses H'200 and H'2FF with the timeout value as an hour, two minutes and three seconds:

```
ar1 PtoP RAM 200 2FF time 1h 2min 3s 0ms 0us 0ns
```

(3) The Start Range To End Range Measurement

[Command syntax and parameters]

- Setting **ARn RtoR <Name> <StartRange> <EndRange>**

Parameter	Type	Description
<i>n</i>	Numeric	Sets a channel number as 1, 3, 5, or 7.
RtoR	Keyword	Makes settings for measurement of time between the specified addresses RtoR.
<Name>	Keyword	Specifies the name of the range.
<StartRange>	Numeric	Specifies a start range. Start address range <StartAddress>:<EndAddress> <StartAddress>: Start address <EndAddress>: End address
<EndRange>	Numeric	Specifies an end range. End address range <StartAddress>:<EndAddress> <StartAddress>: Start address <EndAddress>: End address

[Description]

This command measures time between the ranges of specified addresses.

[Example]

To set a condition of the rate of time spent between the start address range H'100 to H'1FF and the end address range H'200 to H'2FF:

```
ar3 RtoR RAM H'100:H'1FF H'200:H'2FF
```

(4) The Access Count Of Specified Range Measurement

[Command syntax and parameters]

- Setting **AR***n* AC <Name> <Range> <AccessRange> [bus<Type>]

Parameter	Type	Description
<i>n</i>	Numeric	Sets a channel number as 1, 3, 5, or 7.
AC	Keyword	Makes settings for measurement of the number of accesses to AC areas.
<Name>	Keyword	Specifies the name of the range.
<StartRange>	Numeric	Specifies a start range. Start address range <StartAddress>:<EndAddress> <StartAddress>: Start address <EndAddress>: End address
<EndRange>	Numeric	Specifies an end range. End address range <StartAddress>:<EndAddress> <StartAddress>: Start address <EndAddress>: End address
[bus <Type>]	Keyword	Specifies a bus condition. Specification: bus <Type> <Type> = < dmac prefetch data > dmac : DMAC/DTC bus cycles prefetch : CPU prefetch bus cycles data : CPU Data bus cycles Default : All the bus cycles

[Description]

This command measures the number of accesses to AC areas.

[Example]

To set a condition of the rate of time spent for measuring the number of accesses in DMAC bus cycles with the address range H'100 to H'1FF and the accessed area H'200 to H'2FF:

```
ar5 AC RAM H'100:H'1FF H'200:H'2FF bus dmac
```

(5) The Called Count Of Specified Range Measurement

[Command syntax and parameters]

- Setting **AR***n* RC <Name> <Range> <CallRange>

Parameter	Type	Description
<i>n</i>	Numeric	Sets a channel number as 1, 3, 5, or 7.
RC	Keyword	Makes settings for measurement of the number of calls in the specified range RC.
<Name>	Keyword	Specifies the name of the range.
<Range>	Numeric	Specifies the address range of a caller. Address range of a caller <StartAddress>:<EndAddress> <StartAddress>: Start address <EndAddress>: End address
<CallRange>	Numeric	Specifies the address range of a callee. Address range of a callee <StartAddress>:<EndAddress> <StartAddress>: Start address <EndAddress>: End address

[Description]

This command measures the called count of the specified range.

[Example]

To set a condition of the rate of time spent for measuring the called count with the address range H'100 to H'11F and the range of addresses to be called H'120 to H'12F:

```
ar7 RC RAM H'100:H'11F H'120:H'12F
```

(6) Displaying the conditions for measuring the time spent

[Command syntax and parameters]

- Display **AR***n*

Parameter	Type	Description
<i>n</i>	Numeric	Sets a channel number from 1 to 8. At default, conditions set for all the points are displayed.

6.2.3 ANALYSIS_RANGE_DELETE n (AD n)

[Command syntax and parameters]

- Cancellation **ad n** ($n = 1$ to 8)
ad

Parameter	Type	Description
n	Keyword	Settings for cancellation by selecting points adn : Cancels the condition of the point number n . ad : Cancels all the conditions.

[Description]

This command deletes the specified condition of the rate of time spent during the last program run or deletes all conditions.

6.2.4 On-Chip Break Commands (BC, BCn, BCC, BCE, BCR)

- Setting BREAKPOINT_ONCHIP (BC)
- Selection BREAKPOINT_ONCHIP n (BC n)
- Cancellation BREAKPOINT_ONCHIP_CLEAR (BCC)
- Enable or Disable
BREAKPOINT_ONCHIP_ENABLE (BCE)
- Setting a reset point
BREAKPOINT_ONCHIP_RESET (BCR)

[Command syntax and parameters]

- Setting **bc** [<option>...]
<option> = <DISPLAY> | <SEQUENTIAL> | <ADDRESSRANGE> |
<POINTTOPOINT>
- Selection **bc n** ($n = 1 \dots 12$) [<option>...]
<option> = <ADDRESS> | <DATA> | <BUS> | <COUNT> | <ACTION>
- Cancellation **bcc** <channel>
- Enable or Disable
bce <CHANNEL> <MODE>
- Setting a reset point
bcr <ADDRESS>

Description of the bc command <option> (specify one or more conditions)

Parameter	Type	Description
<DISPLAY>	Keyword	Displays the on-chip breakpoints that have been set. Specification: display
<SEQUENTIAL>	Numeric	Selects the sequential level, <level>, from 1 to 8. Specification: sequential <level> <level> = <1 2 3 4 5 6 7 8> When <levels> is omitted, the settings for the sequential breakpoints will be cleared. With 1 to 8 selected, sequential breakpoints can be set from the specified channel to channel 8.
<ADDRESSRANGE>	Numeric or characters	Selects a channel to be used for an address range condition. Specification: addressrange <channels> <channels> = <9-10 11-12> When channels 9 and 10 are selected: 9-10 When channels 11 and 12 are selected: 11-12 When <channels> is omitted, the settings for the address range breakpoints will be cleared.
<POINTTOPOINT>	Keyword	Makes the settings for measuring P to P time. Specification: pointtopoint <channels> <channels> = 7-8 In settings for measurement of P to P time, use channels 7 and 8. When <channels> is omitted, the settings for measurement of P to P time will be cleared.

Description of the *bcn* command <option> (Specify one or more conditions)

Parameter	Type	Description
<i>n</i>	Numeric	Sets the channel number (<i>n</i> = 1 to 12).

Parameter	Description
<ADDRESS>	<p>Specifies an address condition.</p> <p>Specification: <ADDRESS> = address <address> [<address mask>]</p> <p>Specification for a break at the specified address: address <address> <address>: Address value (numeric)</p> <p>Specification for an address mask condition: address <address> <address mask> <address mask>: The digits to be masked for bits of <address> are set as 1 and otherwise 0. They can be displayed in hexadecimal (H'), octal (O'), or binary (B').</p>
<DATA>	<p>Specifies a data condition.</p> <p>Specification: <DATA> = data <data> [<data mask>] [<data size>]</p> <p>Specification for a break with the specified data: data <data> <data>: Data value (numeric)</p> <p>Specification for a data mask condition: data <data> <data mask> <data mask>: The digits to be masked for bits of <data> are set as 1 and otherwise 0. They can be displayed in hexadecimal (H'), octal (O'), or binary (B').</p> <p>Specification for a data size condition: data <data> <data size> <location> <data size>: Select one of the followings for <data size>; For a break with byte-length data: byte <location> For a break with word-length data: word <location> For a break with longword-length data: long <location> <location>: Specifies a location from a 4-byte boundary. 4n: Specifies data from a 4n-byte boundary. 4n1: Specifies data from a 4n-byte boundary + a byte. 4n2: Specifies data from a 4n-byte boundary + two bytes. 4n3: Specifies data from a 4n-byte boundary + three bytes.</p> <p>When no specification is made, 4n will be selected.</p>

Description of the `bcn` command <option> (cont)

Parameter	Description
<BUS>	<p>Selects a bus condition.</p> <p><BUS> = bus [cpu dmac] [prefetch data] [read write]</p> <p>When no specification is made, the condition will be cleared. A read condition must be selected when the type of an access to a bus is prefetch.</p>
cpu dmac	<p>Sets a bus status condition.</p> <p>For a break in execution cycles: cpu For a break in DMA/AUD cycles: dmac</p>
prefetch data	<p>Sets the type of an access to a bus as a break condition.</p> <p>For a break after executing the instruction as the address value at a program fetch matches: prefetch For a break after accessing data: data</p>
read write	<p>Specifies a read/write condition. A read condition must be selected when the type of an access to a bus is prefetch.</p> <p>For a break in read cycles: read For a break in write cycles: write</p>
<COUNT>	<p>Specifies the number of times that a condition matches.</p> <p><COUNT> = count <count></p> <p>count: Specifies the number of times that a condition matches.</p> <p>For a break by the number of times that a condition matches: count <count></p> <p>Values H'1 to H'FFFF can be specified for count.</p> <p>When <count> is omitted, the setting for the number of times that a condition matches will be cleared.</p>
<ACTION>	<p>Specifies an operating condition after a break.</p> <p><ACTION> = action [[break after break before] [trigger]]</p> <p>action: Sets the operation at the satisfaction of a condition.</p> <p>break [after before]</p> <p>For a break after the satisfaction of a condition: action break after For a break before the satisfaction of a condition: action break before For a trigger output at the satisfaction of a condition: action trigger</p> <p>Only channel 8 can be specified when using a sequential break.</p>

Description of the bcc command <option>

Parameter	Description
<CHANNEL>	Specifies channels for which the settings are canceled. Specification of channels for which the settings are canceled: <channels>: <1 2 3 4 5 6 7 8 9 10 11 12> <all> Specify a number or all . When all is selected, all the settings will be canceled.

Description of the bce command <option> (specify one or more conditions)

Parameter	Description
<CHANNEL>	Specifies the execution of a break for each channel. Specification of enable and disable for a channel: <CHANNEL> = <channels> <enable disable> <channels>: <1 2 3 4 5 6 7 8 9 10 11 12> To enable a break at the specified address: enable To disable a break at the specified address: disable

Description of the bcr command <option>

Parameter	Description
<ADDRESS>	Sets a reset point for the specified address. <ADDRESS> = address <address>
	Specifies an address condition. Specification: <ADDRESS> = address <address> To set a reset point at the specified address: address <address> <address>: Address value (numeric)

[Description]

- Setting

This command sets on-chip breakpoints. The program stops when the specified condition is satisfied. For details on conditions that can be specified, refer to the description of <option> in the Bc command section. Sequential breaks using on-chip breaks are also available. Up to eight levels, BREAKPOINT_ONCHIP_1 to BREAKPOINT_ONCHIP_8, of on-chip sequential breaks can be used.

- Selection

This command makes settings for each channel of on-chip breaks. The program stops when the specified condition is satisfied. For details on conditions that can be specified, refer to the description of <option> in the bcn command section.

- Cancellation

This command clears on-chip breakpoints that have been set.

- Enable or Disable

This command enables or disables on-chip breakpoints that have been set.

- Setting a reset point

This command sets a reset point for on-chip breakpoints. It also specifies an address of the reset point for on-chip breakpoints.

6.2.5 On-Emulator Break Commands (BE, BE n , BEC, BEE)

- Setting BREAKPOINT_ONEMULATOR (BE)
- Selection BREAKPOINT_ONEMULATOR n (BE n)
- Cancellation BREAKPOINT_ONEMULATOR_CLEAR (BEC)
- Enable or Disable
BREAKPOINT_ONEMULATOR_ENABLE (BEE)

[Command syntax and parameters]

- Setting **be**
- Selection **ben** ($n = 1 \dots 4$) [<option>...]
 <option> = <ADDRESS> | <DATA> | <BUS> | <COUNT> | <PROBE>
 | <INTERRUPT>
- Cancellation **bec** <CHANNEL>
- Enable or Disable
bee <CHANNEL> <mode>

Description of the *ben* command <option> (specify one or more conditions)

Parameter	Type	Description
<i>n</i>	Numeric	Sets the channel number ($n = 1$ to 4).

Parameter	Description
<ADDRESS>	<p>Specifies an address condition.</p> <p><ADDRESS> = address <address> <start address> <end address> [outside]</p> <p>When no parameter is specified, the address condition will be cleared.</p> <p>Specification for a break at the specified address: address <address> <address>: Address value (numeric)</p> <p>Specification for a break in the specified range of addresses: address <start address> <end address> [outside] <start address>: Address value at the start of the specified range (numeric) <end address>: Address value at the end of the specified range (numeric)</p> <p>Select [outside] to specify those out of the specified range as a break condition.</p>

Description of the *ben* command <option> (cont)

Parameter	Description
<DATA>	<p>Specifies a data condition.</p> <p>Specification: <DATA> = data <data> [<data mask>] [<data size> <location>] [not]</p> <p>When no parameter is specified, the data condition will be cleared.</p> <p>Specification for a break with the specified data: data <data> <data>: Data value (numeric)</p> <p>Specification for a data mask condition: data <data> <data mask> <data mask>: The digits to be masked for bits of <data> are set as 1 and otherwise 0. They can be displayed in hexadecimal (H'), octal (O'), or binary (B').</p> <p>Specification for a data size condition: data <data> <data size> <location> <data size>: Select one of the followings for <data size>; For a break with byte-length data: byte <location> For a break with word-length data: word <location> For a break with longword-length data: long</p> <p><location>: Specifies a location from a 4-byte boundary. 4n: Specifies data from a 4n-byte boundary. 4n1: Specifies data from a 4n-byte boundary + a byte. 4n2: Specifies data from a 4n-byte boundary + two bytes. 4n3: Specifies data from a 4n-byte boundary + three bytes.</p> <p>When no specification is made, 4n will be selected.</p> <p>Add [not] to break with a data value or in the range that have not been specified.</p>

Description of the *ben* command <option> (cont)

Parameter	Description
<BUS>	<p>Selects a bus condition.</p> <p>When no specification is made for bus, the condition will be cleared. When the type of an access to a bus is prefetch, the read condition is assumed.</p> <p><BUS> = bus [cpu dmac] [prefetch data] [read write]</p>
cpu dmac	<p>Sets a bus status condition.</p> <p>For a break in execution cycles: cpu For a break in DMA/DTC cycles: dmac</p>
prefetch data	<p>Sets a condition to break when the bus value matches.</p> <p>For a break after executing the instruction as the address value at a program fetch matches: prefetch For a break after accessing data: data</p>
read write	<p>Specifies a read/write condition. A read condition must be selected when the access type to a bus is prefetch.</p> <p>For a break in read cycles: read For a break in write cycles: write</p>
<COUNT>	<p>Specifies the number of times that a condition matches.</p> <p><COUNT> = count <count></p> <p>When no specification is made for count, the condition will be cleared.</p> <p>count: Specifies the number of times that a condition matches.</p> <p>For a break by the number of times that a condition matches: count <count></p> <p>Values H'1 to H'FFFF can be specified for count.</p>

Description of the *ben* command <option> (cont)

Parameter	Description
<PROBE>	<p>Specifies an external probe signal condition.</p> <p><PROBE> = probe <[probe1 [high low]] [probe2 [high low]] [probe3 [high low]] [probe4 [high low]]></p> <p>When neither high nor low is specified, each of the probe conditions will be cleared.</p>
probe1	<p>Specifies the probe1 signal condition.</p> <p>Specification for the probe1 signal condition: probe1 [high low]</p>
probe2	<p>Specifies the probe2 signal condition.</p> <p>Specification for the probe2 signal condition: probe2 [high low]</p>
probe3	<p>Specifies the probe3 signal condition.</p> <p>Specification for the probe3 signal condition: probe3 [high low]</p>
probe4	<p>Specifies the probe4 signal condition.</p> <p>Specification for the probe4 signal condition: probe4 [high low]</p>

Parameter	Description
<INTERRUPT>	<p>Specifies signal conditions.</p> <p><INTERRUPT> = interrupt <[irq0 [high low]] [irq1 [high low]] [irq2 [high low]] [irq3 [high low]] [irq4 [high low]] [irq5 [high low]] [irq6 [high low]] [irq7 [high low]] [nmi [high low]]></p> <p>When neither high nor low is specified, each of the interrupt conditions will be cleared.</p>
irq0	<p>Specifies the IRQ0 signal condition.</p> <p>For a break by the IRQ0 signal condition: irq0 [high low]</p>
irq1	<p>Specifies the IRQ1 signal condition.</p> <p>For a break by the IRQ1 signal condition: irq1 [high low]</p>
irq2	<p>Specifies the IRQ2 signal condition.</p> <p>For a break by the IRQ2 signal condition: irq2 [high low]</p>
irq3	<p>Specifies the IRQ3 signal condition.</p> <p>For a break by the IRQ3 signal condition: irq3 [high low]</p>
irq4	<p>Specifies the IRQ4 signal condition.</p> <p>For a break by the IRQ4 signal condition: irq4 [high low]</p>
irq5	<p>Specifies the IRQ5 signal condition.</p> <p>For a break by the IRQ5 signal condition: irq5 [high low]</p>
irq6	<p>Specifies the IRQ6 signal condition.</p> <p>For a break by the IRQ6 signal condition: irq6 [high low]</p>
irq7	<p>Specifies the IRQ7 signal condition.</p> <p>For a break by the IRQ7 signal condition: irq7 [high low]</p>
nmi	<p>Specifies the NMI signal condition.</p> <p>For a break by the NMI signal condition: nmi [high low]</p>

Description of the bec command <option>

Parameter	Description
<CHANNEL>	Specifies channels for which the settings are canceled. Specification of channels for which the settings are canceled: <channels>: [1 2 3 4] [all] Specify a number or all . When all is selected, all the settings will be canceled.

Description of the bee command <option>

Parameter	Description
<CHANNEL>	Specifies the execution of a break for each channel. Specification of enable and disable for a channel: <CHANNEL> = <channels> <enable disable> <channels>: [1 2 3 4] To enable a break at the specified address: enable To disable a break at the specified address: disable

[Description]

- Display
This command displays the settings for each channel of on-emulator breaks.
- Selection
This command makes settings for each channel of on-emulator breaks. The program stops when the specified condition is satisfied. For details on conditions that can be specified, refer to the description of <option> in the *ben* command section.
- Cancellation
This command clears on-emulator breakpoints that have been set.
- Enable or Disable
This command enables or disables on-emulator breakpoints that have been set.

6.2.6 Software Break Commands (BS, BSC, BSE)

- Display and Setting BREAKPOINT_SOFTWARE (BS)
- Cancellation BREAKPOINT_SOFTWARE_CLEAR (BSC)
- Enable or Disable
BREAKPOINT_SOFTWARE_ENABLE (BSE)

[Command syntax and parameters]

- Display **bs**
- Setting **bs** <ADDRESS>
- Cancellation **bsc** <ADDRESS>
- Enable or Disable
bse [<ADDRESS>] <MODE>

Parameter	Type	Description
<ADDRESS>	Numeric	Sets an address condition. <ADDRESS> = address <address> When no specification is made, the resource information will be displayed. <address>: Address value (numeric)
<MODE>	Keyword	Enables or disables breakpoints. enable: Enabled disable: Disabled

[Description]

- Setting
This command sets software breakpoints. The emulator sets a software breakpoint by replacing the contents of the specified address with a break instruction (H'0000). Up to 255 software breakpoints can be set.
Do not set software breakpoints to the following addresses:
 - An address whose memory content is H'0000
 - Areas other than CS (except for the on-chip ROM/RAM area)
 - Slot instruction of the delay branch instruction
- Cancellation
This command clears software breakpoints that have been set.
- Enable or Disable
This command enables or disables software breakpoints that have been set.

6.2.7 CLOCK (CK)

[Command syntax and parameters]

- Setting **ck** <mode>
- Display **ck**

Parameter	Type	Description
<mode>	Keyword	Selects the clock signal. 5 : Clock signal (5 MHz) of the emulator 10 : Clock signal (10 MHz) of the emulator T : Target xtal : Crystal oscillator of the head board

[Description]

This command displays and sets clock signal used in the MCU.

The user can select whether to use the clock signal from the user system or from the emulator. When the user selects a clock, the emulator resets the MCU. Therefore, the on-chip I/O registers and control registers hold the reset values.

This command displays the type of the clock signal that has been set.

6.2.8 CONFIGURATION_PLATFORM (CP)

[Command syntax and parameters]

- Setting **cp** [<option>...]
 <option> = <USER_VCC> | <INTERRUPT> | <HUDI>
 | <INPUT_FREQUENCY> | <AUD> | <MULTI_BREAK>
 | <FLASH_LOAD_OPTION> | <BUS_TIMEOUT>
- Display **cp**

Parameter	Type	Description
<USER_VCC>	Numeric	Displays and selects the voltage level of the user system. <USER_VCC> = user_vcc <VCC> Specify the value as the voltage level of the user system for <VCC>. Select from the range 0.00 to 5.10.
<INTERRUPT>	Keyword	Displays and selects interrupts during the execution of steps. <INTERRUPT> = interrupt <INT> <INT> = <enable disable> To enable interrupts: enable To disable interrupts: disable
<HUDI>	Keyword	Displays and selects the HUDI clock. <HUDI> = hudi <hudi> <hudi> = <10MHz 15MHz 20MHz>
<INPUT_FREQUENCY>	Keyword	Displays and selects the input frequency. <INPUT_FREQUENCY> = input_frequency <fre> <fre> = <5MHz 10MHz>
<AUD>	Keyword	Displays and selects the AUD function. <AUD> = aud <AUD> <AUD> = <emulator user> To use by the emulator: emulator To use by the user: user
<MULTI_BREAK>	Keyword	Specifies whether or not to enable the multibreak function. <MULTI_BREAK> = multi_break <mul> <mul> = <multibreak non> To enable the multibreak function: multibreak To disable the multibreak function: non

Description of the CONFIGURATION_PLATFORM (CP) options (cont)

Parameter	Type	Description
<FLASH_LOAD_OPTION>	Keyword	<p>Specifies a method of loading a program to the on-chip flash memory.</p> <p><FLASH_LOAD_OPTION> = flash_load_option <fla> <fla> = <disable update erase allerase></p> <p>disable: Loading of a program to the on-chip flash memory is prohibited. A verification error occurs if loading of a program to the on-chip flash memory is attempted.</p> <p>update: In this mode, a program can be loaded into the on-chip flash memory. The contents of the on-chip flash memory, except for the program to be loaded, will be the same as those before loading.</p> <p>erase: In this mode, a program can be loaded into the on-chip flash memory. Certain blocks in the on-chip flash memory are erased before loading a program.</p> <p>allerase: In this mode, a program can be loaded into the on-chip flash memory. The contents of the on-chip flash memory are all erased before loading a program.</p>
<BUS_TIMEOUT>	Keyword	<p>Specifies a bus timeout detection period.</p> <p><BUS_TIMEOUT> = bus_timeout <bus> <bus> = <100us 1.6ms 13ms 210ms></p>

[Description]

This command displays and makes the settings required for the operation of the emulator.

[Examples]

1. To display the current settings:

```
cp
```

2. To set the voltage level of the user system as 4.10 V:

```
cp user_vcc 4.10
```

6.2.9 DEVICE_TYPE (DE)

[Command syntax and parameters]

- Setting **de** <device>
- Display **de**

Parameter	Type	Description
<device>	Keyword	Sets up the device type to emulate, or displays the current device type. Default: Displays the current device type. sh7058: Set the device to the SH7058. 7058: Set the device to the SH7058.

[Description]

This command displays the current device type.

[Examples]

1. To display the device type:

```
de
```

2. To set the device to the SH7058:

```
de sh7058
```

3. To set the device to the SH7058:

```
de 7058
```

6.2.10 ERAM (EM)

[Command syntax and parameters]

- Setting **em** [<mode>]
- Display **em**

Parameter	Type	Description
<mode>	Keyword	Sets the ERAM mode. <mode> = <user> <eml> <auto> When the emulation RAM is used by the user program; <user> = user When the emulation RAM is used for emulation of the on-chip ROM; <eml> = eml <REL> <ROM> When the emulation RAM is used to set software breakpoints automatically; <auto> = auto <REL> <ROM>
<REL> <ROM>	Keyword	Releases and allocates the emulation RAM. To release the emulation RAM: <REL> = release <eram> To allocate the emulation RAM: <ROM> = onrom <eram> <option>
<eram>	Keyword	Selects the emulation RAM to be set. <eram> = < eram0 eram1 eram2 eram3 eram4 eram5 eram6 eram7 >
<option>	Keyword	Makes the other settings. <option> = address <add> toflash toeram address <add>: Specifies the address to be allocated. <add>: Numeric toflash : Writes the contents of the emulation memory into the on-chip flash memory. toeram : Writes the contents of the on-chip flash memory into the emulation RAM.

[Description]

This command sets an emulation memory or displays its contents.

[Examples]

1. To display the settings made for the emulation memory:

```
em
```

2. To use ERAM0 for emulation as the on-chip ROM of H'1000:

```
em eml rom eram0 1000
```

3. Not to release emulation of ERAM0:

```
em eml release eram0
```

4. To use the emulation RAM as a user RAM:

```
em user
```

5. To use the emulation RAM to set software breakpoints automatically:

```
em auto
```

6.2.11 FLASH_MEMORY (FM)

[Command syntax and parameters]

- Setting **fm** <LOCATE>
<LOCATE> = <0 | 1 | 2 | 3 | 4 | 5 | 6 | 7 | 8 | 9 | 10 | 11 | 12 | 13 | 14 | 15 | all>

[Description]

This command erases the user mat of the selected on-chip flash memory.

[Examples]

1. To erase the user mat area 0:

```
fm 0
```

2. To erase the user mat areas 1 and 2:

```
fm 1 2
```

6.2.12 MAP_DISPLAY (MA)

[Command syntax and parameters]

- Display **ma**

[Description]

This command displays the current configuration of the memory map.

[Example]

To display the current configuration of the memory map:

ma

6.2.13 MODE (MO)

[Command syntax and parameters]

- Display **mo**
- Setting **mo <MODE>**
<MODE> = <0 || 1 || 2 || 3 || TARGET>

Parameter	Type	Description
<MODE>	Keyword	Specifies the MCU mode. 0 : Selects the 8-bit bus mode. 1 : Selects the 16-bit bus mode. 2 : Selects the on-chip ROM enabled mode. 3 : Selects the on-chip ROM disabled mode. TARGET : Selects the mode set in the user system.

[Description]

This command selects the MCU mode.

[Example]

To set the MCU mode to mode 1:

```
mo 1
```

6.2.14 REFRESH (RF)

[Command syntax and parameters]

rf

[Description]

This command updates the HDI memory information to the latest information.

6.2.15 TEST_EMULATOR (TE)

[Command syntax and parameters]

- Test **te**

[Description]

Tests the on-chip flash memory area in the following order:

- (1) Erases all area (except the user boot mat) in the on-chip flash memory. If an error occurs during erasing, the processing is suspended.
- (2) Writes H'AA to all areas. If an error occurs during writing, the processing is suspended.
- (3) Reads all areas. If the read data is not H'AA, the processing is suspended.
- (4) Erases all areas. If an error occurs during erasing, the processing is suspended.
- (5) Writes H'55 to all areas. If an error occurs during writing, the processing is suspended.
- (6) Reads all areas. If the read data is not H'55, the processing is suspended.
- (7) Erases all areas. If an error occurs during erasing, the processing is suspended.
- (8) Writes H'00 to all areas. If an error occurs during writing, the processing is suspended.
- (9) Reads all areas. If the read data is not H'00, the processing is suspended.
- (10) Erases all data. If an error occurs during erasing, the processing is suspended.
- (11) Command processing is completed.

6.2.16 TIMER (TI)

[Command syntax and parameters]

- Display **ti**
- Setting **ti** <timer resolution>
<timer resolution> = <**20ns** || **1.6us** || **52us** || **CLOCK1** || **CLOCK2** || **CLOCK4** || **CLOCK8**>

Parameter	Type	Description
<timer resolution>	Keyword	Sets or displays the minimum time for time measurement. 20ns : The minimum time is set to 20 ns. 1.6us : The minimum time is set to 1.6 us. 52us : The minimum time is set to 52 us. CLOCK1 : The minimum time is set to the CPU clock. CLOCK2 : The minimum time is set to 1/2 of the CPU clock. CLOCK4 : The minimum time is set to 1/4 of the CPU clock. CLOCK8 : The minimum time is set to 1/8 of the CPU clock.

[Description]

This command displays or sets the minimum time for time measurement. This affects the execution time and the event timing.

6.2.17 TRACE_ACQUISITION (TA, TA*n*)

- Setting TRACEACQUISITION (TA)
- Selection TRACEACQUISITION*n* (TA*n*)
- Cancellation TRACEACQUISITION_CLEAR (TAC)

[Command syntax and parameters]

- Setting and display **ta** <option> [<option>...]
<option> = <DISPLAY> | <SEQUENTIAL> | <TRIGGERTIME> | <FREE> | <FULL> | <UNIT> | <SUPPRESS> | <RESET> | <SELECT>
- Selection **tan** (*n* = 1...12) <option> [<option>...]
<option> = <ACTION> | <ADDRESS> | <DATA> | <BUS> | <PROBE> | <INTERRUPT> | <COUNT> | <DELAY>
- Cancellation **tac** <CHANNEL>

Description of command `ta <option>` (specify one or more conditions)

Parameter	Type	Description
<DISPLAY>	Keyword	Displays trace points that have been set. Specification: display
<SEQUENTIAL>	Numeric or keyword	Selects the sequential level. Specification: sequential <level> <level> = <1 2 3 4 5 6 7 8>
<TRIGGERTIME>	Numeric or keyword	Specifies the channels between which the trace time is measured. Specification: triggertime <channels> <channels> = <1-2 3-4 5-6 7-8>
<FREE>	Keyword	Specifies free trace. Specification: free [ok] free ok : Sets free trace. free : Clears free trace.
<FULL>	Keyword	Specifies the processing when the trace buffer is full. Specification: full <action> <action> = < noaction stoptrace stopexecution > noaction : No special processing is done. Continues storing the trace results from the top of the trace buffer. stoptrace : Stops storing the trace results. stopexecution : Stops execution and stops storing trace results.
<UNIT>	Keyword	Specifies the time unit for trace measurement. Specification: unit <timeunit> <timeunit> = <20ns 1.6us 52us>
<SUPPRESS>	Keyword	Specifies the bus cycle type which trace results are not acquired. Specification: suppress <type> <type> = dmac
<RESET>	Keyword	Specifies the reset point. Specification: reset [ok] reset ok : Sets a reset point. reset : Clears the reset point.
<SELECT>	Keyword	Specifies the display format of timestamp and IRQ7 to IRQ0. Specification: select <timestamp indication> timestamp : Enables all the 32-bit timestamp counters. indication : Displays the status of IRQ7 to IRQ0 in bit units. The lower 16 bits of the timestamp counter are fixed to 0.

Description of command *tan* <option> (specify one or more conditions)

Parameter	Type	Description
<i>n</i>	Numeric	Sets the channel number. A value from 1 to 12 can be specified.

Parameter	Description
<ACTION>	<p>Specifies the processing after the trace condition is satisfied. Specification: action <operate> <operate> = <tracestop rangetrace [next] acquisition none> [trigger]</p> <p>tracestop: Stops trace.</p> <p>rangetrace [next]: Starts range trace. When next is specified, the next channel is used for the trace condition setting.</p> <p>acquisition: Acquires trace condition.</p> <p>none: Specifies the trigger output condition for “Time measurement between trigger Outputs” of Trace Acquisition Condition.</p> <p>trigger: Specifies the trigger output after the trace condition is satisfied.</p>

Parameter	Description
<ADDRESS>	<p>Specifies the address condition. <ADDRESS> = address <<address> <start address> <end address> [outside]></p> <p>When the parameters are not specified, clears the address condition.</p> <p>To specify the address condition: address <address> <address>: Address value (numeric)</p> <p>To specify the range address condition: address <start address> <end address> [outside] <start address>: The start address of the specified range (numeric) <end address>: The end address of the specified range (numeric) Specify outside to specify the address outside the specified range as the condition.</p>

Parameter	Description
<DATA>	<p>Specifies the data condition. <DATA> = data <data> [<data mask>] [<data size> <location>] [not] When the parameters are not specified, clears the data condition.</p> <p>To specify the data condition: data <data> <data>: Data value (numeric)</p> <p>To specify the data mask condition: data <data> <data mask> <data mask>: The digits to be masked for bits of <data> are set as 1 and otherwise 0. They can be displayed in hexadecimal (H'), octal (O'), or binary (B').</p> <p>To specify the data size condition: data <data> <data size> <location> <data size>: Select from the following: byte <location>: When the byte data size is the condition. word <location>: When the word data size is the condition. long: When the longword data size is the condition.</p> <p><location> specifies the position from the 4-byte boundary. 4n: Specifies data from a 4n-byte boundary. 4n1: Specifies data from a 4n-byte boundary + a byte. 4n2: Specifies data from a 4n-byte boundary + two bytes. 4n3: Specifies data from a 4n-byte boundary + three bytes. When <location> is not specified, 4n is assumed. When <ACTION> is set to rangetrace, <location> cannot be specified.</p> <p>Add [not] to specify a value other than the specified data value or a value outside the specified range as the condition.</p>

Description of command *tan* <option> (cont)

Parameter	Description
<BUS>	<p>Specifies the bus condition. <BUS> = bus [[cpu dmac aud] [prefetch data] [read write]]</p> <p>Clears the condition when the bus condition is not specified.</p> <p>When the access type is prefetch, the read condition is assumed.</p> <p>When <ACTION> is set to rangetrace, <BUS> cannot be specified.</p>
cpu dmac	<p>Sets the bus status condition. To set the execution cycle as the condition: cpu To set the DMAC cycle as the condition: dmac</p>
prefetch data	<p>Sets the bus access type as the condition. To set the instruction execution cycle whose address bus matches the bus type when the program is fetched: prefetch To set the data access as the bus condition: data</p>
read write	<p>Sets the read or write condition. When the bus access type is prefetch, the read condition is assumed. To set the read cycle as the bus condition: read To set the write cycle as the bus condition: write</p>

Parameter	Description
<PROBE>	<p>Specifies the external probe signal condition. <PROBE> = probe <[probe1 [high low]] [probe2 [high low]] [probe3 [high low]] [probe4 [high low]]></p> <p>When high or low is not specified, clears each probe condition.</p>
probe1	To specify probe1 signal condition: probe1 [high low]
probe2	To specify probe2 signal condition: probe2 [high low]
probe3	To specify probe3 signal condition: probe3 [high low]
probe4	To specify probe4 signal condition: probe4 [high low]

Description of command *tan* <option> (cont)

Parameter	Description
<INTERRUPT>	<p>Specifies the interrupt signal condition.</p> <p><INTERRUPT> = interrupt <[irq0 [high low]] [irq1 [high low]] [irq2 [high low]] [irq3 [high low]]> [irq4 [high low]] [irq5 [high low]]> [irq6 [high low]] [irq7 [high low]]> [nmi [high low]]></p> <p>When high or low is not specified, clears each interrupt condition.</p>
irq0	To specify IRQ0 signal condition: irq0 [high low]
irq1	To specify IRQ1 signal condition: irq1 [high low]
irq2	To specify IRQ2 signal condition: irq2 [high low]
irq3	To specify IRQ3 signal condition: irq3 [high low]
irq4	To specify IRQ4 signal condition: irq4 [high low]
irq5	To specify IRQ5 signal condition: irq5 [high low]
irq6	To specify IRQ6 signal condition: irq6 [high low]
irq7	To specify IRQ7 signal condition: irq7 [high low]
nmi	To specify NMI signal condition: nmi [high low]

Parameter	Description
<COUNT>	<p>Specifies the number of times the condition is matched.</p> <p><COUNT> = count <count></p> <p>When the parameter is not specified, clears the count condition.</p> <p>To specify the number of times the condition is matched:</p> <p>count <count></p> <p><count>: A value from H'1 to H'FFFF</p>

Parameter	Description
<DELAY>	<p>Specifies the number of trace delay cycles as the condition.</p> <p><DELAY> = delay <delay></p> <p>When the parameter is not specified, clears the delay condition.</p> <p>To specify the number of trace delay cycles:</p> <p>delay <delay></p> <p><delay>: The number of trace delay cycles in decimal.</p>

Description of command `ta <option>` (specify one or more conditions)

Parameter	Description
<code><CHANNEL></code>	<p>Clears the channel that has been set.</p> <p><code><CHANNEL> = <1 2 3 4 5 6 7 8 9 10 11 12> <all></code></p> <p>Select a numeric or all. When all is selected, all channel settings are cleared.</p>

[Description]

- **Setting**
This command sets conditions for acquiring trace information. For conditions that can be set, refer to the description of command `ta <option>`.
- **Selection**
This command select channel condition for acquiring trace information. When the specified condition is satisfied, the program execution is terminated. For conditions that can be set, refer to the description of command `tan <option>`.
- **Cancellation**
This command clears conditions for acquiring trace information.

6.2.18 TRACE_ALL (TL)

[Command syntax and parameters]

- Setting, display **tl** <option>
 <option> = <<record> [counter] || **old** [counter] >> || **all**

[Description]

Displays the trace records from the data in the cycle specified by [record]. The number of records is specified by [counter].

<record> must be -131071 or more and 65534 or less.

[counter] must be 0 or more and 131071 or less.

[Examples]

1. To display 10 records of the latest trace data that was executed most recently:

```
tl
```

2. To display 10 records of trace data from -30 cycle:

```
tl -30
```

3. To display 20 records of trace data from -50 cycle:

```
tl -50 20
```

4. To display 10 records of the oldest data in the trace buffer:

```
tl OLD
```

5. To display 5 records of the oldest data in the trace buffer:

```
tl old 5
```

6. To display all trace data in the trace buffer:

```
tl all
```

[Notes]

1. When all parameters are omitted, 10 records of trace data which was executed most recently are displayed.
2. When old is specified, the oldest data in the trace buffer becomes the display start trace record.
3. When all is specified, all data in the trace buffer are output.
4. When <count> is omitted, 10 is assumed.
5. When a cycle prior to the cycle in the trace buffer is specified, the number of trace records specified by <count> from the oldest data in the trace buffer are displayed.
6. When a cycle later than the cycles in the trace buffer is specified, the following message is displayed:

Trace record out of range

7. When the number of records in the trace buffer is large, and all is specified, it may take some time to output all the data and in the meantime, the HDI cannot be operated.

6.2.19 TRACE_COMPARE (TC)

[Command syntax and parameters]

tc <filename>

<filename>: Name of the trace file to be compared.

[Description]

Compares the trace data with the trace file which is saved (refer to section 6.2.20, TRACE_SAVE).

6.2.20 TRACE_SAVE (TV)

[Command syntax and parameters]

tv <filename>

<filename>: Name of the trace file to be saved.

[Description]

Saves the trace data in a file.

6.2.21 TRACE_SEARCH (TS)

[Command syntax and parameters]

ts [<option>...]

<option> = [<ADDRESS> | <DATA> | <BUS> | <PROBE> | <INTERRUPT> | <TIME> |
<FROM>]

Description of command **ts** <option> (specify one or more conditions)

Parameter	Description
<ADDRESS>	<p>Specifies the address condition to be displayed.</p> <p>Specification: <ADDRESS> = address <address> [<address mask>][not]</p> <p>When the parameter is not specified, clears the address condition.</p> <p>To specify the address condition: address <address> [not]</p> <p><address>: Address value (numeric)</p> <p>Add not to specify a value that is not specified as the condition.</p> <p>To specify the address mask condition:</p> <p>address <address> <address mask> [not]</p> <p><address mask>: The digits to be masked for bits of <address> are set as 1 and otherwise 0. They can be displayed in hexadecimal (H'), octal (O'), or binary (B').</p> <p>Add [not] to specify a value other than the specified address value or a value outside the specified range as the condition.</p>

Description of command ts <option> (cont)

Parameter	Description
<DATA>	<p>Specifies the data condition. <DATA> = data <data> [<data mask>] [<data size> <location>] [not] When the parameters are not specified, clears the data condition.</p> <p>To specify the data condition: data <data> <data>: Data value (numeric)</p> <p>To specify the data mask condition: data <data> <data mask> <data mask>: The digits to be masked for bits of <data> are set as 1 and otherwise 0. They can be displayed in hexadecimal (H'), octal (O'), or binary (B').</p> <p>To specify the data size condition: data <data> <data size> <location> <data size>: Select from the following: byte <location>: When the byte data size is the condition. word <location>: When the word data size is the condition. long: When the longword data size is the condition.</p> <p><location> specifies the position from the 4-byte boundary. 4n: Specifies data from a 4n-byte boundary. 4n1: Specifies data from a 4n-byte boundary + a byte. 4n2: Specifies data from a 4n-byte boundary + two bytes. 4n3: Specifies data from a 4n-byte boundary + three bytes. When <location> is not specified, 4n is assumed.</p> <p>Add [not] to specify a value other than the specified data value or a value outside the specified range as the condition.</p>

Description of command `ts <option>` (cont)

Parameter	Description
<code><BUS></code>	<p>Specifies the bus condition. <code><BUS> = bus [cpu dmac aud] [prefetch data] [read write]</code></p> <p>Clears the condition when the bus condition is not specified.</p> <p>When the access type is prefetch, the read condition is assumed.</p>
cpu dmac	<p>Sets the bus status condition. To set the execution cycle as the condition: cpu To set the DMAC cycle as the condition: dmac</p>
prefetch data	<p>Sets the bus access type as the condition. To set the instruction execution cycle whose address bus matches the bus type when the program is fetched: prefetch To set the data access as the bus condition: data</p>
read write	<p>Sets the read or write condition. When the bus access type is prefetch, the read condition is assumed. To set the read cycle as the bus condition: read To set the write cycle as the bus condition: write</p>

Parameter	Description
<code><PROBE></code>	<p>Specifies the external probe signal condition. <code><PROBE> = probe [<probe1 [high low] [probe2 [high low] probe3 [high low] probe4 [high low]></code></p> <p>When high or low is not specified, clears each probe condition.</p>
probe1	To specify probe1 signal condition: probe1 [high low]
probe2	To specify probe2 signal condition: probe2 [high low]
probe3	To specify probe3 signal condition: probe3 [high low]
probe4	To specify probe4 signal condition: probe4 [high low]

Description of command ts <option> (cont)

Parameter	Description
<INTERRUPT>	Specifies the interrupt signal condition. <INTERRUPT> = interrupt <[irq0 [high low]] [irq1 [high low]] [irq2 [high low]] [irq3 [high low]] [irq4 [high low]] [irq5 [high low]] [irq6 [high low]] [irq7 [high low]] [nmi [high low]]> When high or low is not specified, clears the timestamp condition.
irq0	To specify IRQ0 signal condition: irq0 [high low]
irq1	To specify IRQ1 signal condition: irq1 [high low]
irq2	To specify IRQ2 signal condition: irq2 [high low]
irq3	To specify IRQ3 signal condition: irq3 [high low]
irq4	To specify IRQ4 signal condition: irq4 [high low]
irq5	To specify IRQ5 signal condition: irq5 [high low]
irq6	To specify IRQ6 signal condition: irq6 [high low]
irq7	To specify IRQ7 signal condition: irq7 [high low]
nmi	To specify NMI signal condition: nmi [high low]

Description of command ts <option> (cont)

Parameter	Description
<TIME>	<p>Specifies the timestamp condition.</p> <p><TIME> = time point range from <time1> [to <time2>]</p> <p>When the parameter is not specified, the timestamp is cleared.</p> <p>time</p> <p>To specify the timestamp condition: time point range from <time1> [to <time2>]</p> <p>To search with the specified time: time point from <time1></p> <p>To search with the specified range of time: time range from <time1> to <time2></p> <p>The specification of the search time <time1> to and <time2>: hhh[:mm[:ss[:uuuuu]]]</p> <p>hhh: Hours (0 to 999 are valid) mm: Minutes (0 to 59 are valid) ss: Seconds (0 to 59 are valid) uuuuu: Microseconds (0 to 999999 are valid)</p>

Parameter	Description
<FROM>	<p>Specifies the trace start location. When the location is not specified, the start of 64k is assumed. Search cycle range is from -65534 to 65534.</p> <p><FROM> = from <cycle></p> <p><cycle>: A numeric from -65534 to 65534</p>

[Description]

Specifies the conditions for displaying trace data. For each condition, see the description of command ts <option>.

6.2.22 USER_SIGNALS (US)

[Command syntax and parameters]

- Display **us**
- Enabled/disabled **us <enable [nmi | reset | busrq | wait] || disable [nmi | reset | busrq | wait]>**

[Description]

Sets whether or not the user signals (NMI, reset, standby, bus request, and wait) are enabled or disabled. When the parameter is not set, displays the enabled or disabled status of these signals.

[Examples]

1. To display the status of the user signals:

```
us
```

2. To enable the NMI signal:

```
us enable nmi
```

3. To disable the BREQ signal:

```
us disable busrq
```

Section 7 Error Messages

7.1 Error Messages of the Emulator

7.1.1 Error messages at Emulator Initiation

The emulator displays error messages in the format below if an error occurs at emulator initiation in the dedicated message dialog box when the HDI is used.

Table 7.1 lists error messages at emulator initiation.

Table 7.1 Error Messages at Initiation

Error Message	Description and Solution
Can't find config file	The configuration file that is required to initiate the HDI cannot be found. Re-install the HDI.
Invalid config file	The configuration file that is required to initiate the HDI is invalid. Re-install the HDI.
Main Board not Support(XX XX XX) Emulator is switched off or not connected	The emulator power is not turned on, or the user system interface cable is not connected. Exit the HDI, re-connect the user system interface cable, turn on the power of the emulator, and re-initiate the HDI. If the problem is not solved, contact the Hitachi sales office where you purchased the HDI, and describe the error occurrence in detail.
Evaluation Board not Support(XX XX XX) EVA Chip Board not Support(XX XX XX)	Exit the HDI, re-connect the user system interface cable, turn on the power of the emulator, and re-initiate the HDI. If the problem is not solved, contact the Hitachi sales office where you purchased the HDI, and describe the error occurrence in detail.
Can't initialize G/A registers	An error occurred during the initialization of the emulator. Exit the HDI, re-connect the user system interface cable, turn on the power of the emulator, and re-initiate the HDI. If the problem is not solved, contact the Hitachi sales office where you purchased the HDI, and describe the error occurrence in detail.
There is no effective clock source	A valid clock source cannot be found. Exit the HDI, re-connect the user system interface cable, connect a valid clock source by referring to the manual, turn on the power of the emulator, and re-initiate the HDI. If the problem is not solved, contact the Hitachi sales office where you purchased the HDI, and describe the error occurrence in detail.

Table 7.1 Error Messages at Initiation (cont)

Error Message	Description and Solution
Firmware Name Error Can't find firmware file Firmware open Error Firmware Download Error	There is an error in the file that is required at emulator initiation. Exit the HDI, and re-install the HDI. Reconnect the user system interface cable, turn on the power of the emulator, and re-initiate the HDI. If the problem is not solved, contact the Hitachi sales office where you purchased the HDI, and describe the error occurrence in detail.
JTAG Timeout Srval Error JTAG Packet Receive Error	Exit the HDI, reconnect the user system interface cable, turn on the power of the emulator, and re-initiate the HDI. If the problem is not solved, contact the Hitachi sales office where you purchased the HDI, and describe the error occurrence in detail.
TARGET ERROR	An error other than above has occurred. Exit the HDI, reconnect the user system interface cable, turn on the power of the emulator, and re-initiate the HDI. If the problem is not solved, contact the Hitachi sales office where you purchased the HDI, and describe the error occurrence in detail.

7.1.2 Error messages during Emulation

The emulator displays error messages if an error occurs during emulation in the dedicated message dialog box when the HDI is used, and on the status bar. Table 7.2 lists error messages during emulation.

Table 7.2 Error Messages during Emulation

Error Message	Description and Solution
No Clock occurred	Clock oscillation has stopped. Exit the HDI, reconnect the user system interface cable, connect a valid clock source by referring to the manual, turn on the power of the emulator, and re-initiate the HDI. If the problem is not solved, contact the Hitachi sales office where you purchased the HDI, and describe the error occurrence in detail.

7.2 HDI Error Messages Related to the Emulator

Error messages that occur in HDI processing are also displayed in error-message dialog boxes. Tables 7.3 lists these error messages, descriptions of the errors, and solutions to the errors.

Table 7.3 HDI Error Messages

Error Message	Description and Solution
Command not ready	The function that was attempted to be executed is not available now.
NOT FOUND	The specified data or information does not exist. Check the specified data.
VERIFY ERROR ADDRESS H'xxxxxxxx WRITE: H'xx Read: H'xx	Verification error occurred. (xx: numerical value).
Invalid address	The specified address is invalid.
Invalid version number in target configuration	The HDI version when the session file was created is different from the current HDI. Do not use the session file of the old version.
function not available Currently not available Command currently not available	The used function is not available.
Not support	The function is not supported.
Invalid parameter	The parameter of the command is incorrect.

7.3 Error Messages for the LAN Driver

When the LAN adapter (HS6000ELN01H) is used, error messages of the following type may be output due to a network problem.

WSxxxxxxxx: <error message>

WSxxxxxxxx : Error code (xxxxxxxx is an alphanumeric string)

<error message> : Error message that corresponds to the error code

If such an error message is output, consult your system manager.

Appendix A User System Interface Circuit

A.1 User System Interface Circuit

The circuits that interface the MCU in the emulator to the user system include buffers and resistors. When connecting the emulator to a user system, adjust the user system hardware compensating for FANIN, FANOUT, and propagation delays.

The AC timing values when using the emulator are shown in table A.1.

Note: The values with the emulator connected, in table A.1, are measurements for reference and are not guaranteed values.

Table A.1 Bus Timing when Using the Emulator (Bus Clock: 20.0 MHz)

Item	MCU Specifications (ns)		Values with Emulator Connected (ns)	
	Min	Max	Min	Max
tRDS	15	—	18	—
tACC	$tcyc \times (n + 1.5) - 39$ (n is the number of waits)	—	$tcyc \times (n + 1.5) - 45$ (n is the number of waits)	—

The basic bus cycle (software wait) is shown in figure A.1. The user system interface circuits connected to the user system are shown in figure A.2.

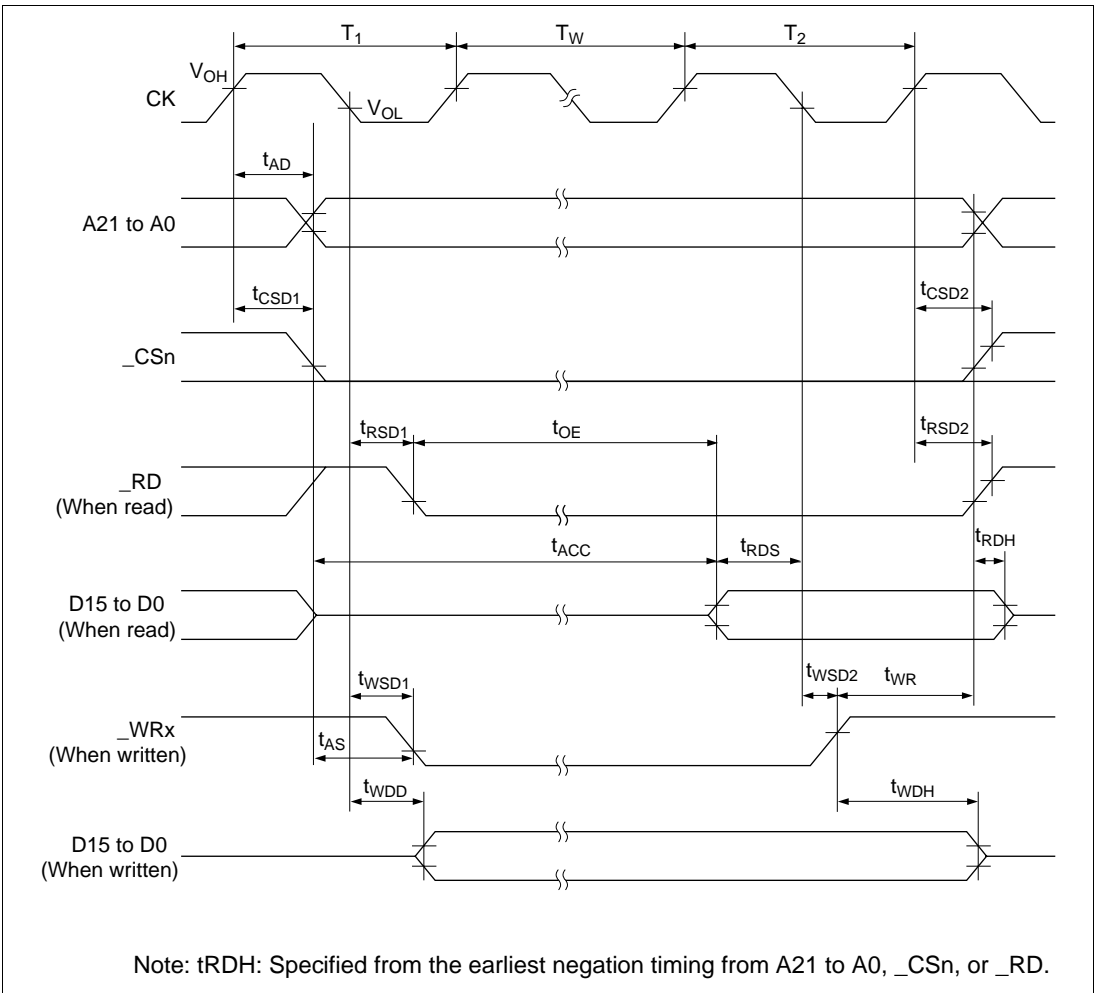

Figure A.1 Basic Bus Cycle (Software Wait)

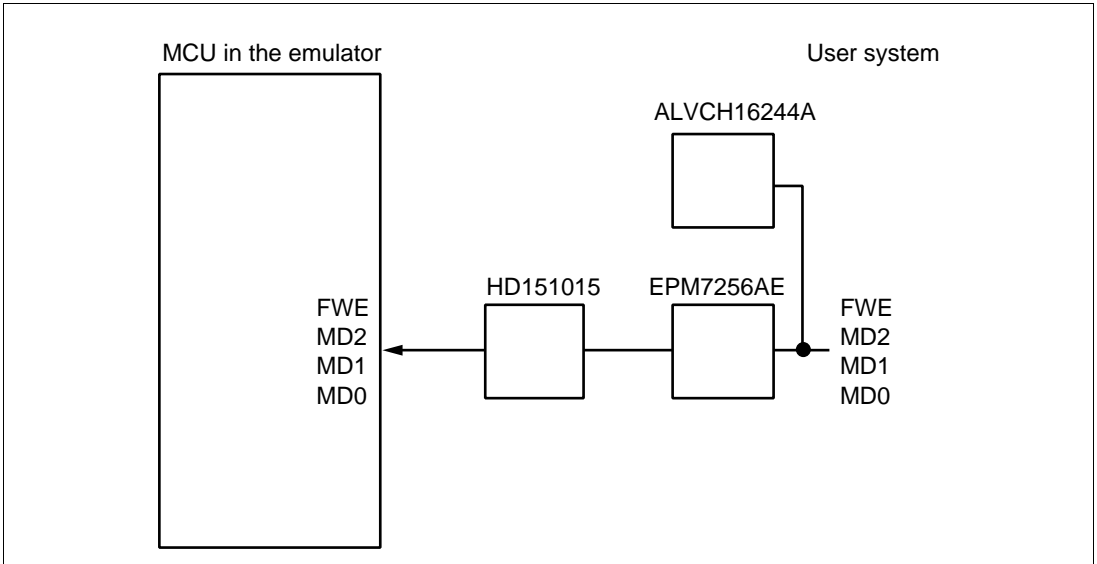

Figure A.2 User System Interface Circuits (1)

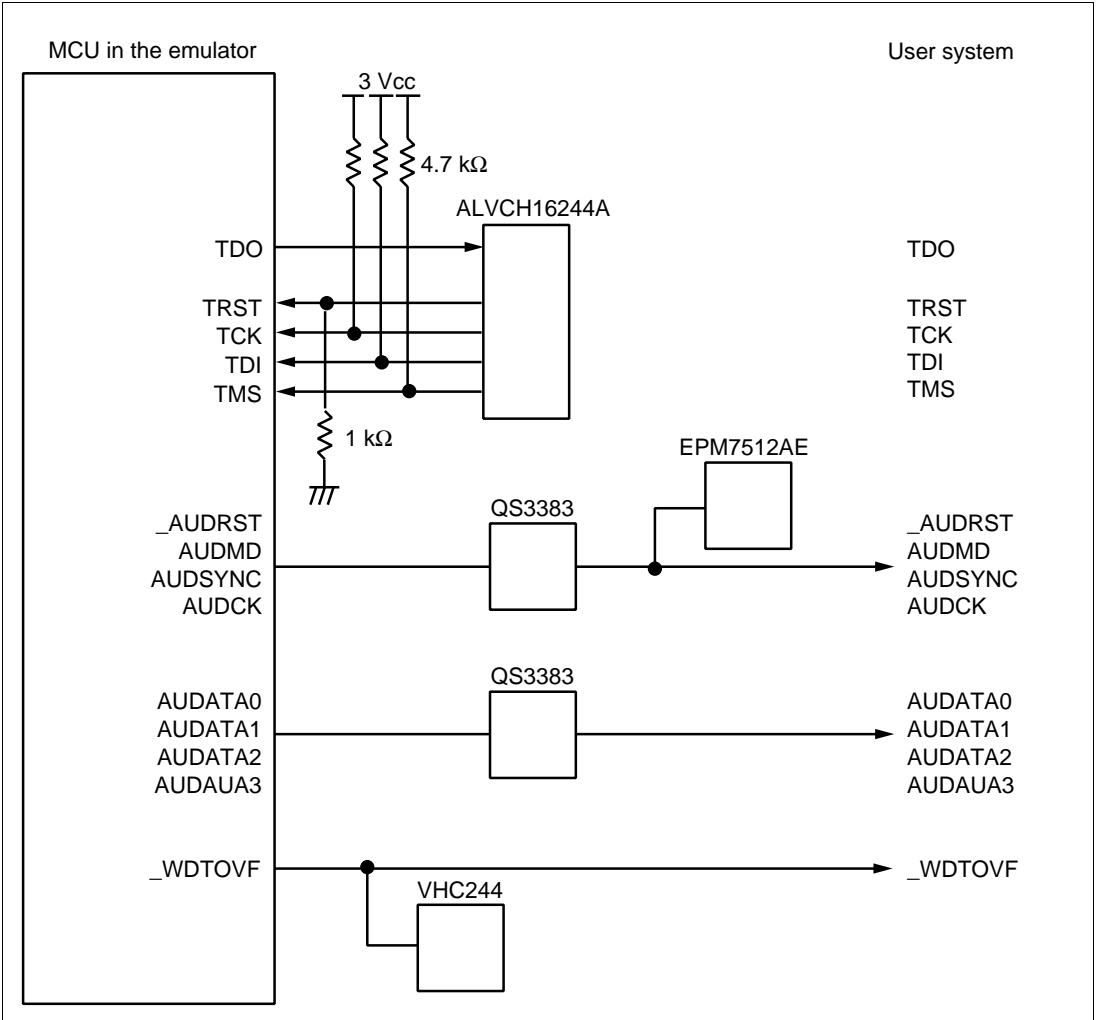

Figure A.2 User System Interface Circuits (2)

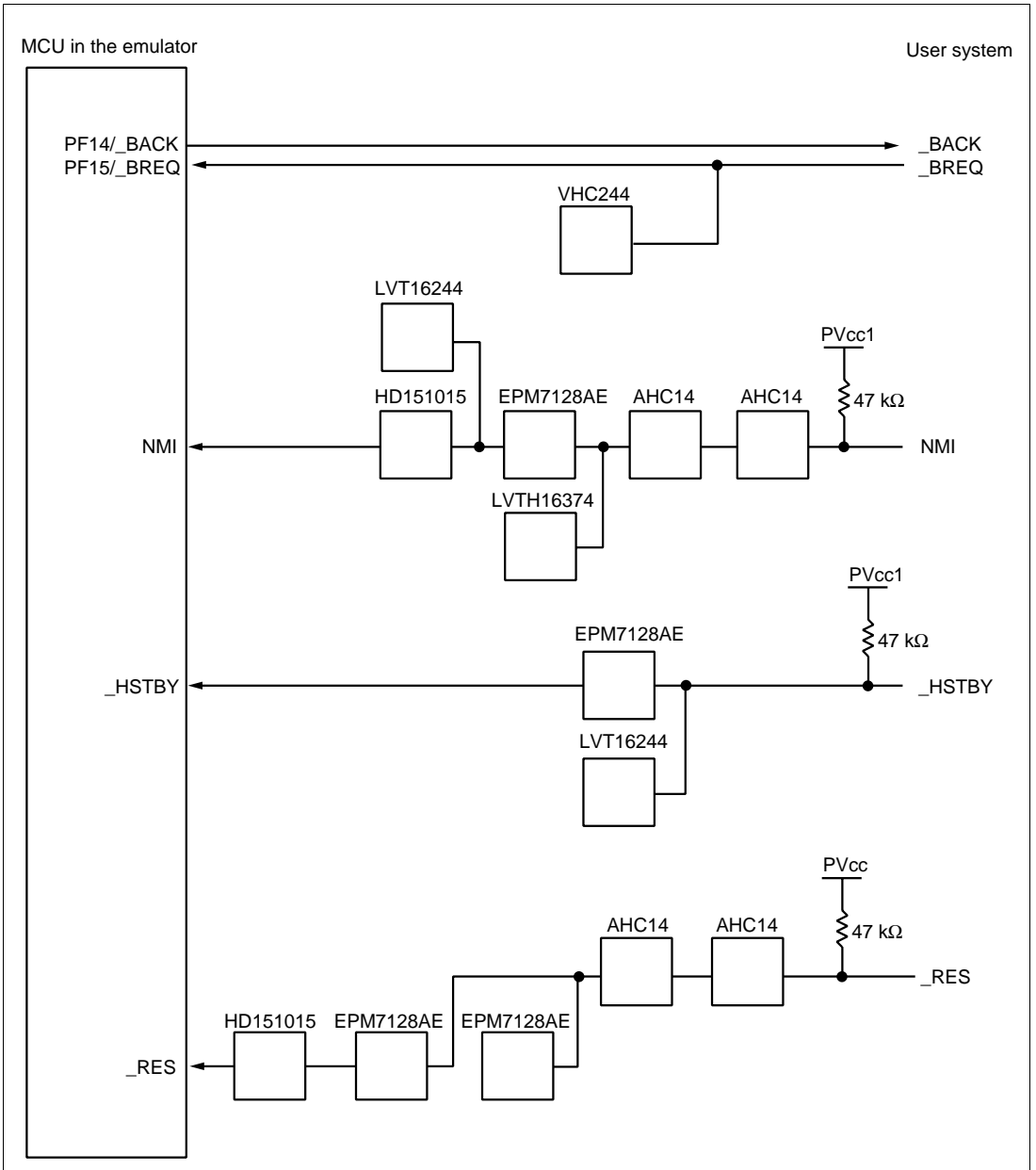

Figure A.2 User System Interface Circuits (3)

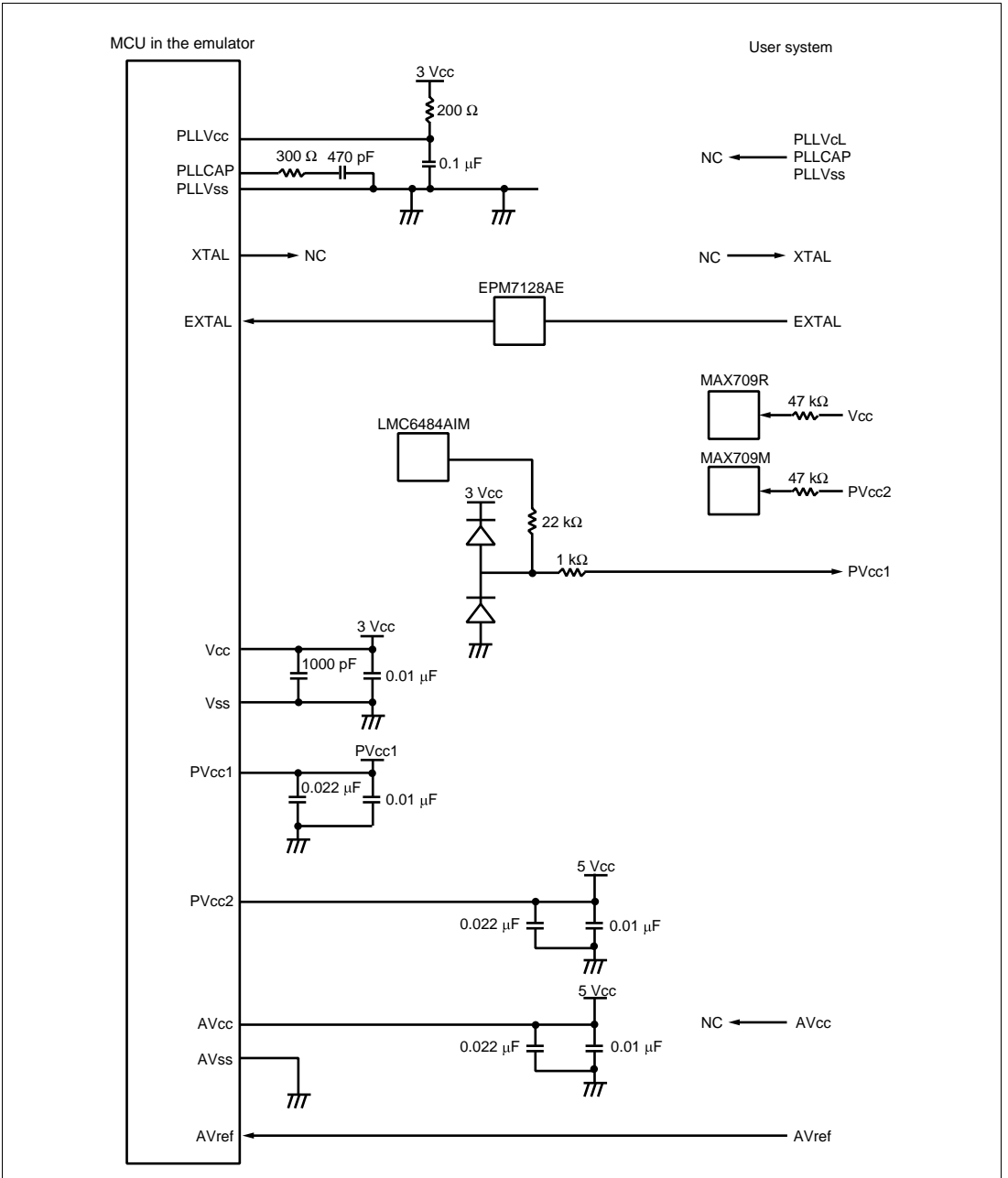

Figure A.2 User System Interface Circuits (4)

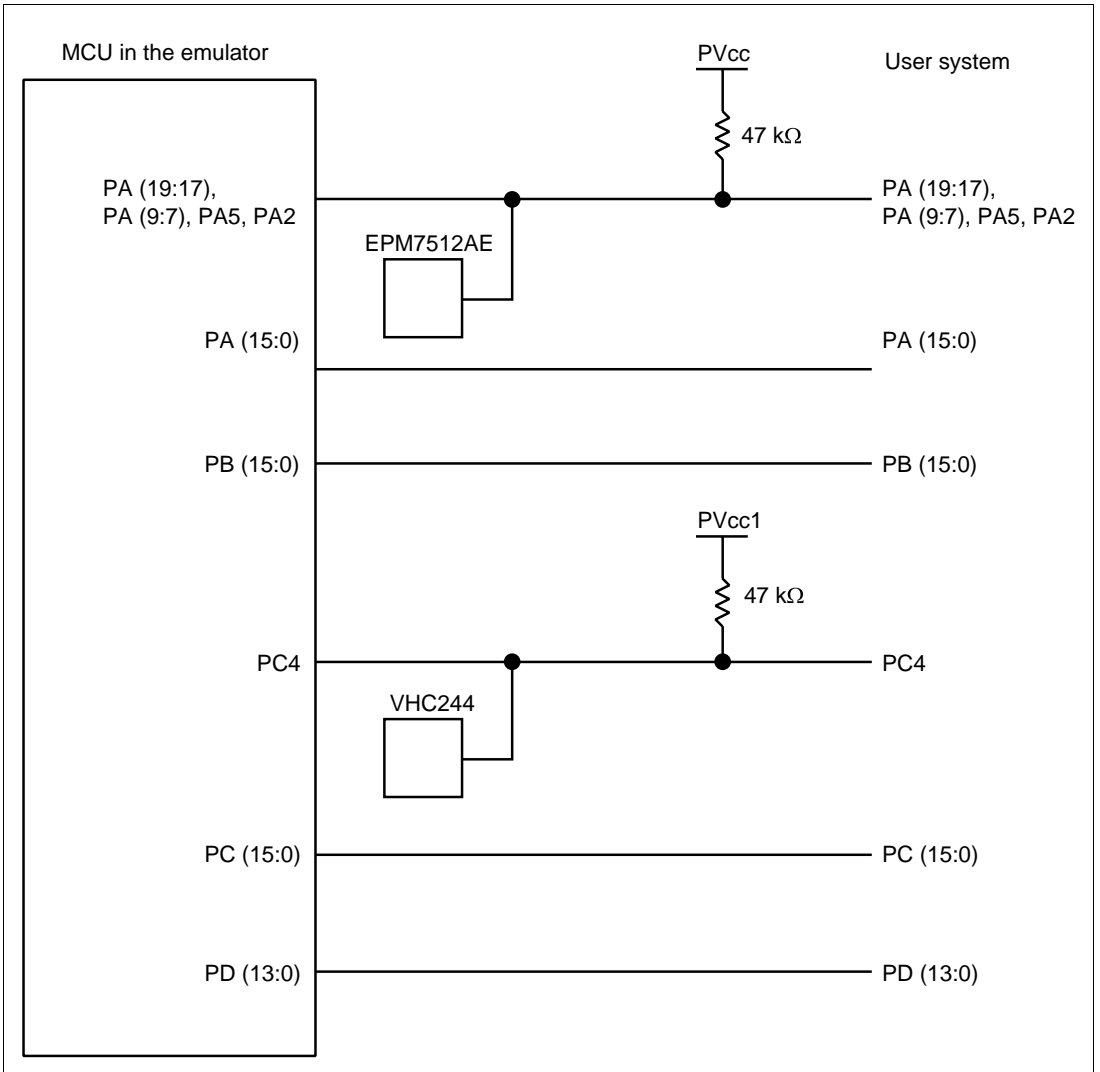

Figure A.2 User System Interface Circuits (5)

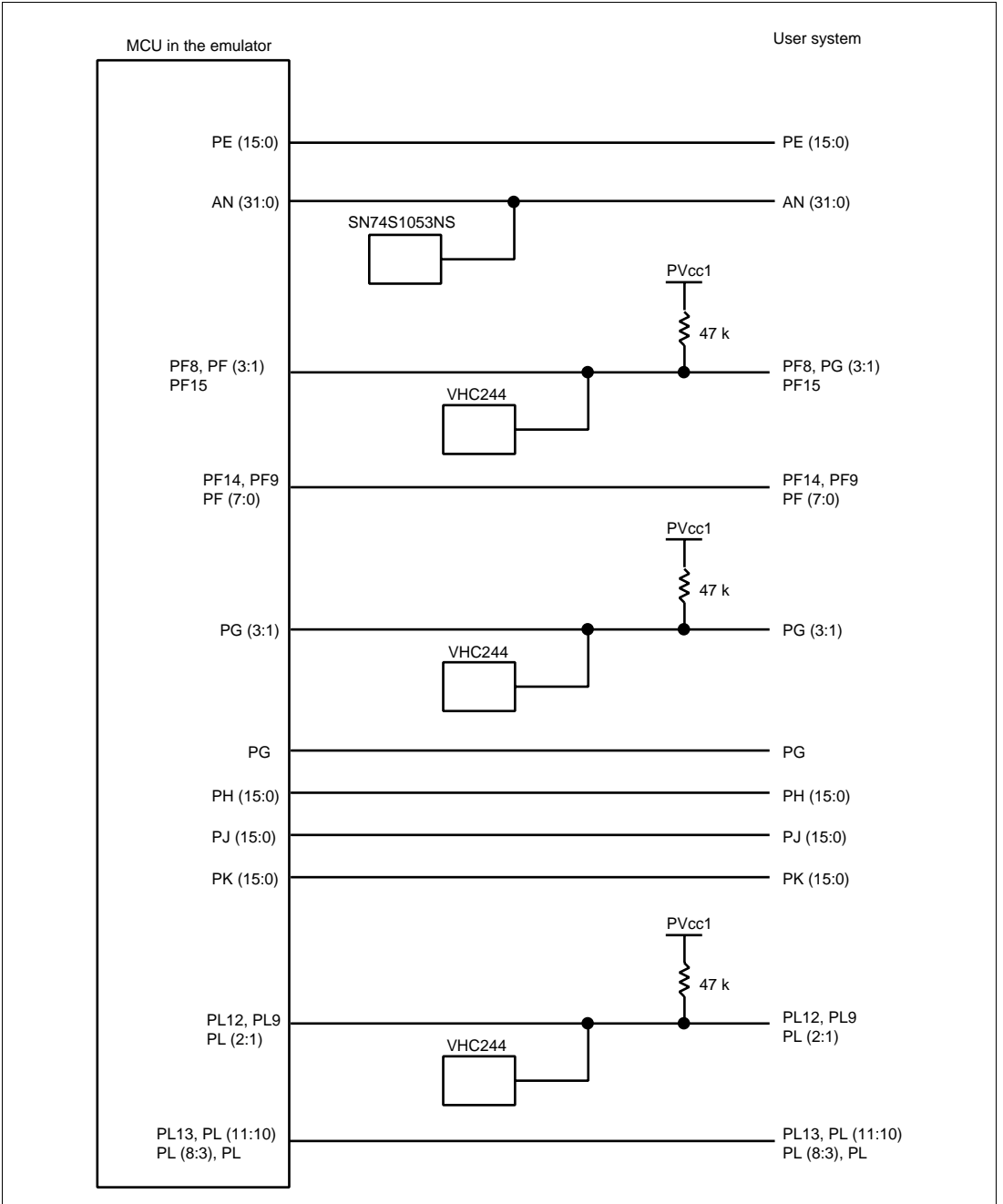

Figure A.2 User System Interface Circuits (6)

Appendix B Emulator External Dimensions and Mass

Figures B.1 shows the external dimensions and mass of the E6000H emulator.

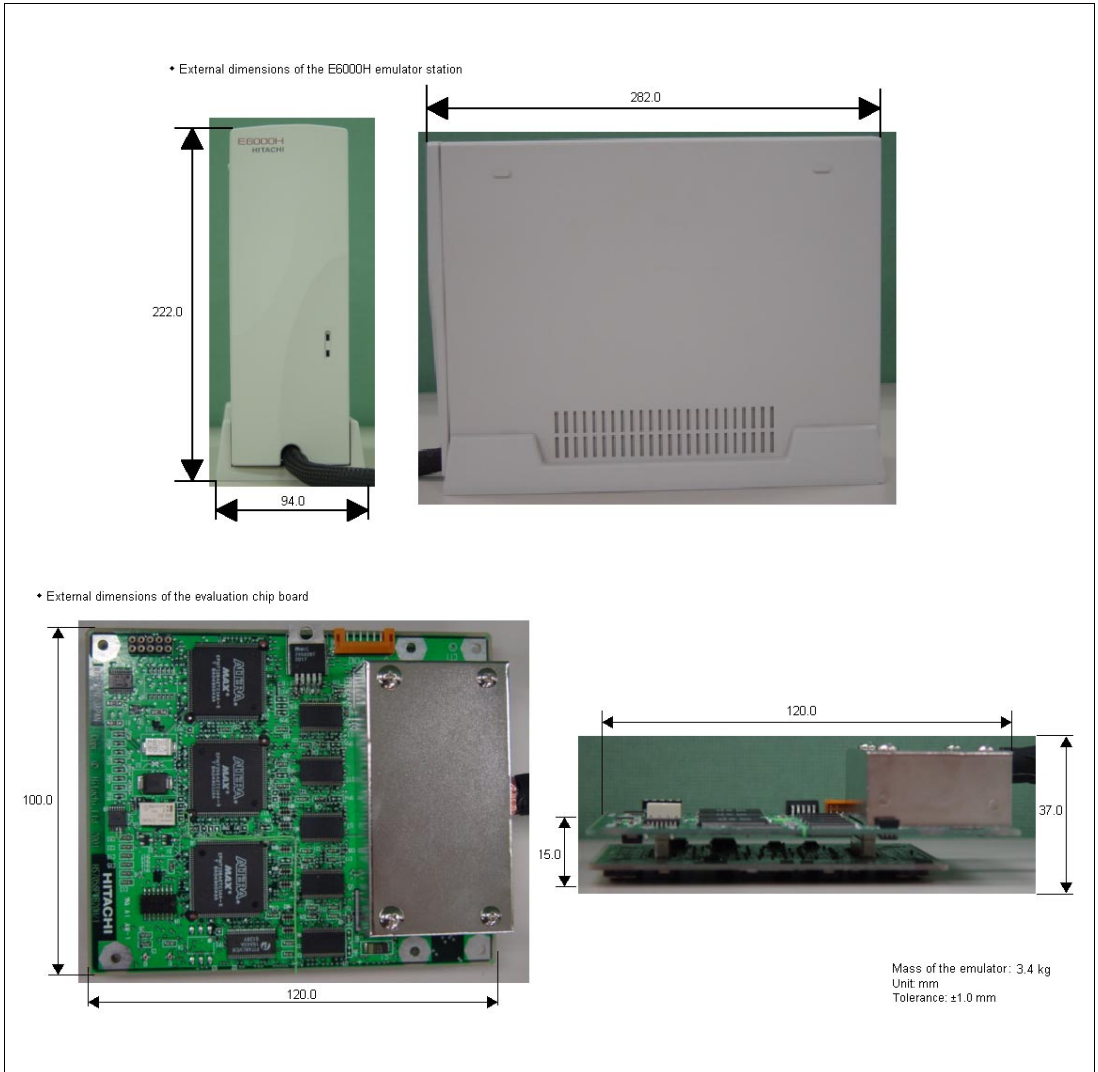

Figure B.1 External Dimensions and Mass of the Emulator

Appendix C Connecting the Emulator to the User System

C.1 Connecting to the User System

WARNING

Always switch OFF the emulator and user system before connecting or disconnecting any CABLES. Failure to do so will result in a FIRE HAZARD, and will damage the user system or emulator or result in PERSONAL INJURY. Also, the USER PROGRAM will be LOST.

The emulator is connected to the user system by using the user system interface board.

Table C.1 User System Interface Board and User Interfaces

User System Interface Board	User Interface
HS7058ECF61H	FP-256H (TQPACK256RD)*

Note: The TQPACK series is manufactured by Tokyo Eletech Corporation.

C.1.1 Installing IC Socket

1. Installing IC Socket

Install the IC socket for an FP-256H package to the user system. After checking the location of pin 1 on the IC socket, apply epoxy resin adhesive to the bottom of the IC, and fasten it to the user system before soldering.

2. Soldering IC Socket

After fastening, solder the IC socket to the user system. Be sure to completely solder the leads so that the solder slops gently over the leads and forms solder fillets. (Use slightly more solder than the MCU.)

C.1.2 Connection Using the HS7058ECF61H

WARNING

Always switch OFF the emulator and user system before connecting or disconnecting any CABLES. Failure to do so will result in a FIRE HAZARD, and will damage the user system or emulator or result in PERSONAL INJURY. Also, the USER PROGRAM will be LOST.

- Notes:
1. For more details on the HS7058ECF61H, refer to the user's manual supplied with the emulator.
 2. This user system interface board can only be used in combination with the specified QFP socket (TQPACK256RD).

Install the FP-256H pin socket (TQPACK256RD manufactured by Tokyo Eletech Corporation) on the user system to connect the emulator. Since the pin arrangement is the same as that of the actual MCU, refer to the hardware manual.

Figure C.1 shows the connection of the HS7058ECF61H, figure C.2 shows the size restrictions for the installed components of the HS7058ECF61H, and figure C.3 shows the recommended mount pad dimensions of the user system IC socket.

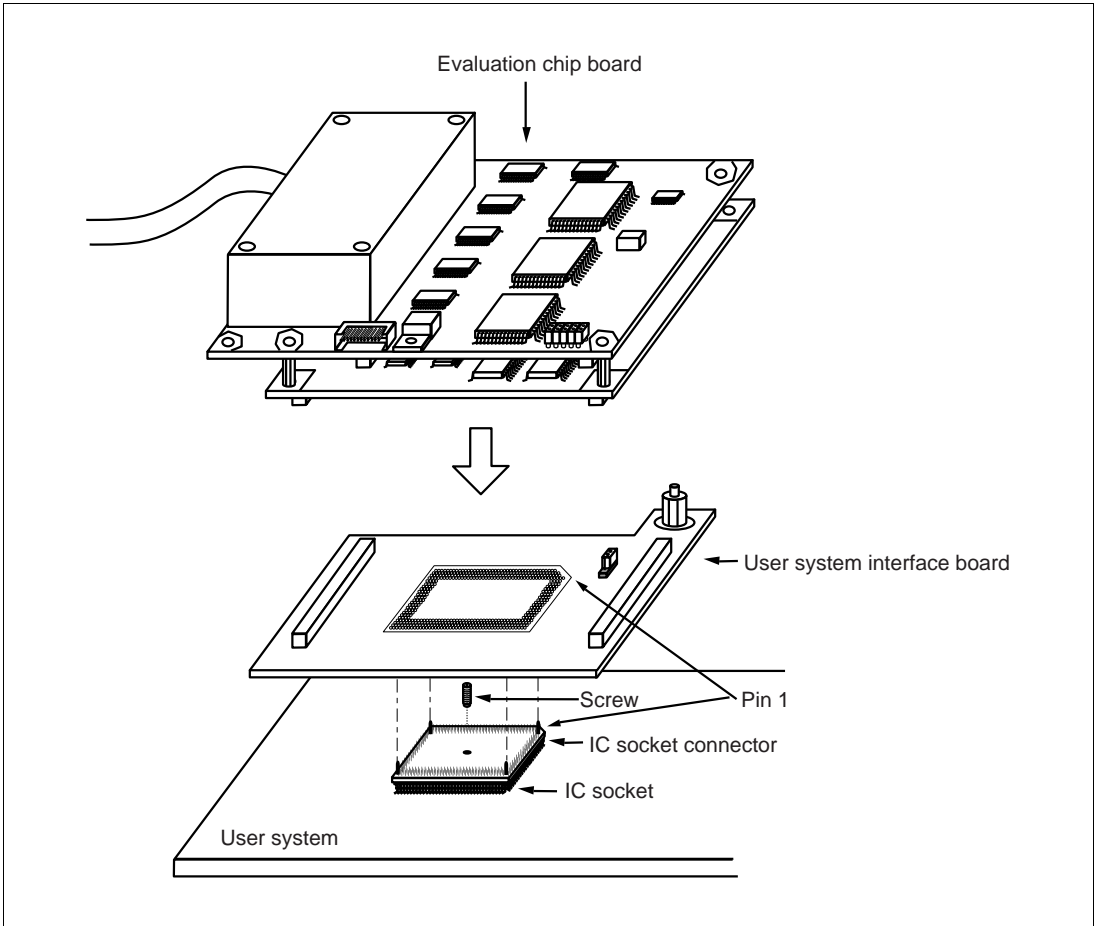

Figure C.1 Connection Using the HS7058ECF61H

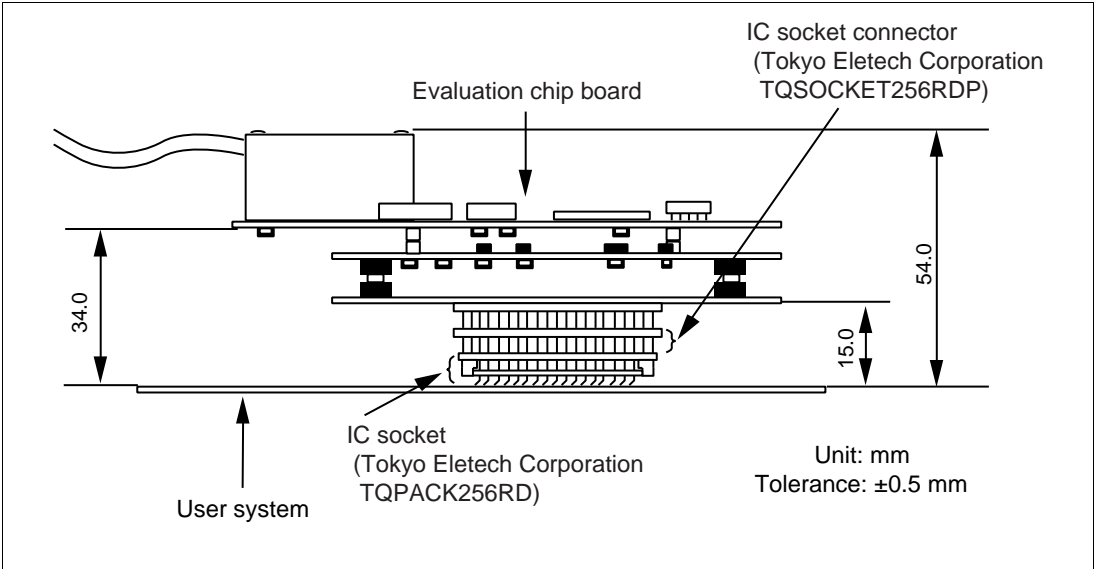
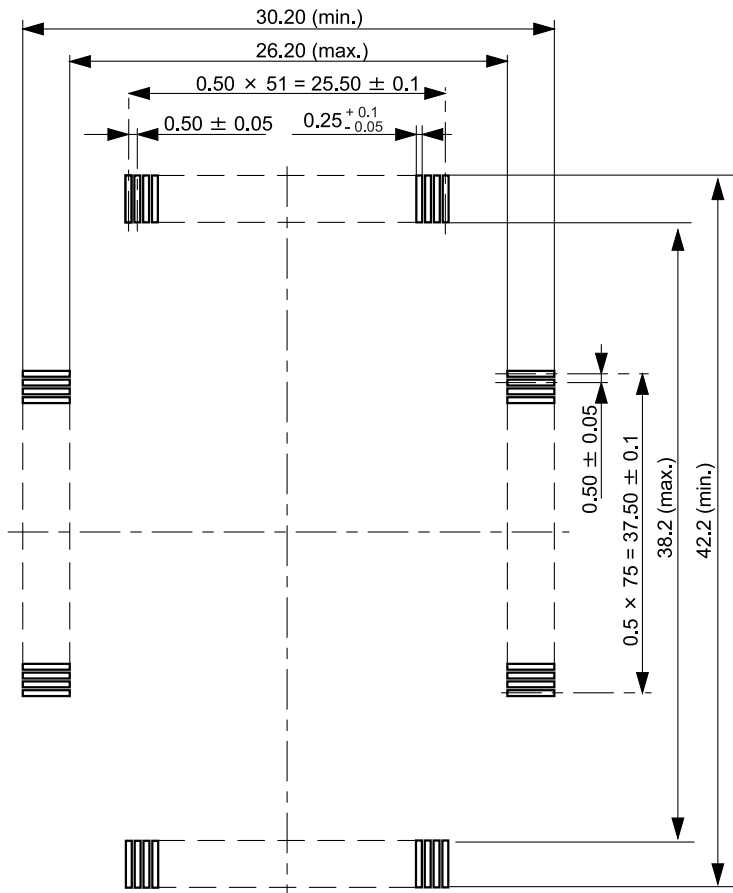

Figure C.2 Restrictions on Component Installation



Unit: mm

Tolerance (unless otherwise specified): ± 0.3 mm

Figure C.3 Recommended Mount Pad Dimensions of the User System IC Socket

C.1.3 Connection Using the Dedicated Connector

WARNING

Always switch OFF the emulator and user system before connecting or disconnecting any CABLES. Failure to do so will result in a FIRE HAZARD, and will damage the user system or emulator or result in PERSONAL INJURY. Also, the USER PROGRAM will be LOST. For correct connection, check the location of pin 1.

Note: This evaluation chip board can only be used in combination with the specified dedicated connector (WD-200P-VF85-N).

Install the dedicated connector (WD-200P-VF85-N manufactured by Japan Aviation Electronics Industry, Ltd.) on the user system to connect the emulator. Figures C.4 to C.6 show connection using the dedicated connector, size restrictions for the installed components, and the location for mounting the connector in the user system, respectively.

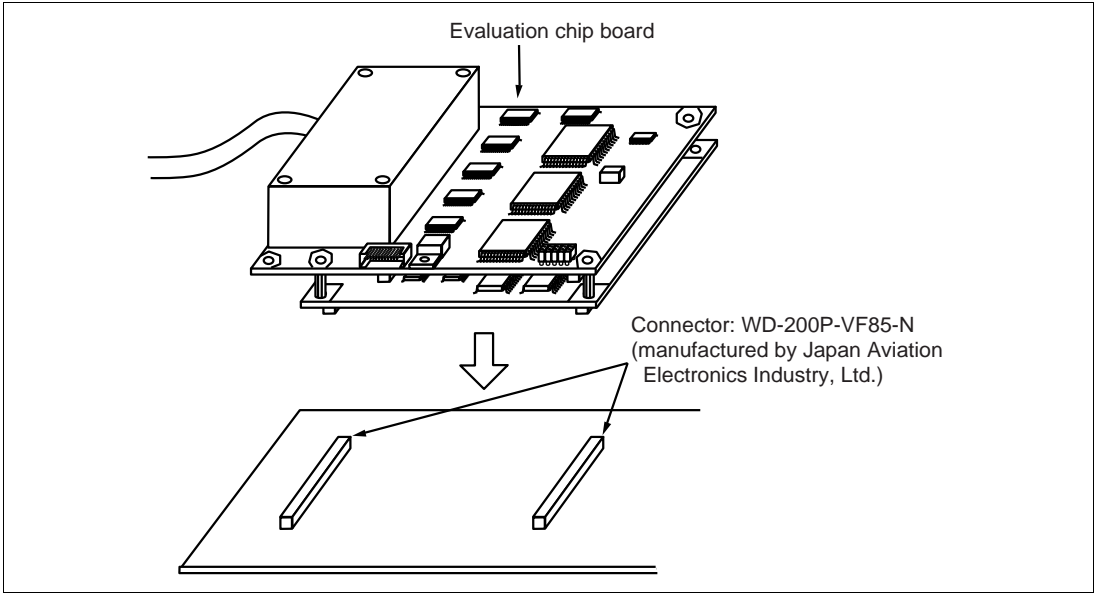

Figure C.4 Connection Using the Dedicated Connector

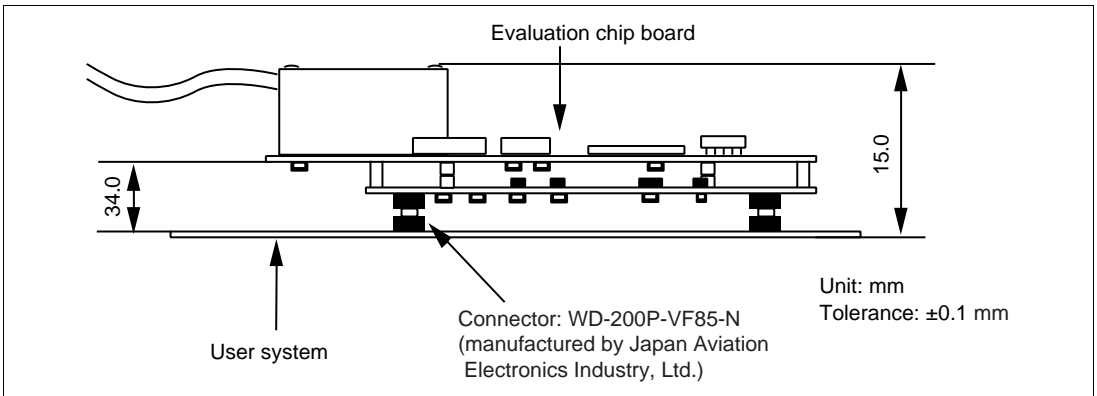

Figure C.5 Size Restrictions for the Installed Components

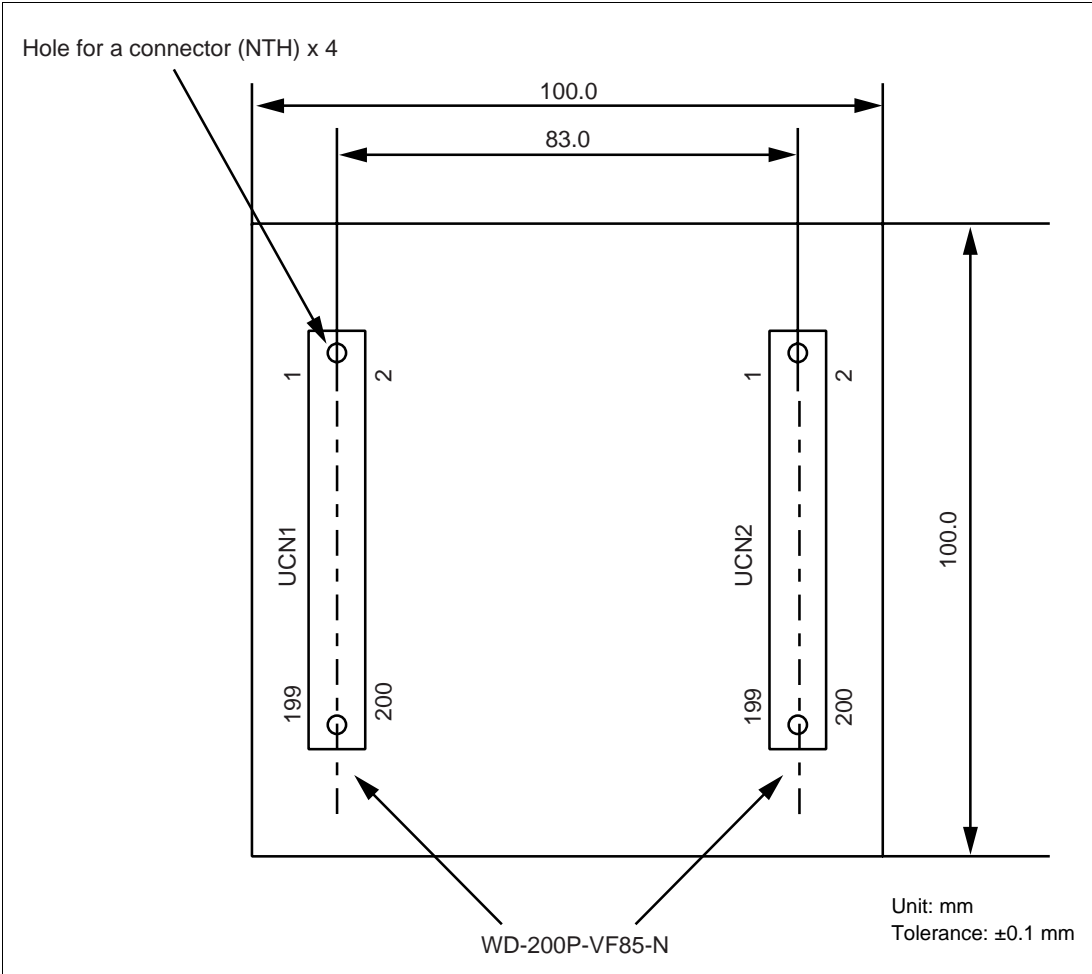

Figure C.6 Location for Mounting the Connector in the User System

To design the foot pattern, refer to the catalog on WD-200P-VF85-N for dimensions.

C.2 Pin Arrangement on the User System Interface Connector

Table C.2 lists the pin arrangement on the user system interface connector of HS7058EPH60H.

Table C.2 Pin Arrangement on HS7058EPH60H

User I/F 1	Pin No.	Signal Name	User I/F 1	Pin No.	Signal Name
UCN1	1	GND	UCN1	25	PF8/_WAIT
	2	GND		26	GND
	3	GND		27	GND
	4	GND		28	PE7/A7
	5	GND		29	PF7/_WRH
	6	GND		30	PE6/A6
	7	GND (TGBON1)		31	PF6/_WRL
	8	PE15/A15		32	PE5/A5
	9	PF15/_BREQ		33	PF5/A21/_POD
	10	PE14/A14		34	PE4/A4
	11	PF14/_BACK		35	PF4/A20
	12	PE13/A13		36	GND
	13	PF13/_CS3		37	GND
	14	PE12/A12		38	PE3/A3
	15	PF12/_CS2		39	PF3/A19
	16	GND		40	PE2/A2
	17	GND		41	PF2/A18
	18	PE11/A11		42	PE1/A1
	19	PF11/_CS1		43	PF1/A17
	20	PE10/A10		44	PE0/A0
	21	PF10/_CS0		45	PF0/A16
	22	PE9/A9		46	GND
	23	PF9/_RD		47	GND
	24	PE8/A8		48	PD13/PULS6/ HRxD0/HTxD1

Table C.2 Pin Arrangement on HS7058EPH60H (cont)

User I/F 1	Pin No.	Signal Name	User I/F 1	Pin No.	Signal Name
UCN1	49	GND	UCN1	75	GND
	50	PD12/PULS4		76	PD2/TIO1C
	51	GND		77	GND
	52	GND		78	PD1/TIO1B
	53	GND		79	GND
	54	PD11/PULS3		80	PD0/TIO1A
	55	GND		81	AUDCK
	56	PD10/PULS2		82	GND
	57	GND		83	AUDMD
	58	PD9/PULS1		84	PL13/_IRQOUT
	59	GND		85	_AUDSYNC
	60	PD8/PULS0		86	PL12/_IRQ4
	61	GND		87	_AUDRST
	62	GND		88	GND
	63	GND		89	GND
	64	PD7/TIO1H		90	PL11/HRxD/HRxD1/ HRxD0&HRxD1
	65	GND		91	AUDATA3
	66	PD6/TIO1G		92	PL10/HTxD0/ HTxD1/HTxD0&HTxD 1
	67	GND		93	AUDATA2
	68	PD5/TIO1F		94	PL9/SCK4/_IRQ5
	69	GND		95	AUDATA1
	70	PD4/TIO1E		96	PL8/SCK3
	71	GND		97	AUDATA0
	72	GND		98	GND
	73	GND		99	N.C.
	74	PD3/TIO1D		100	PL7/SCK2

Table C.2 Pin Arrangement on HS7058EPH60H (cont)

User I/F 1	Pin No.	Signal Name	User I/F 1	Pin No.	Signal Name
UCN1	101	3Vcc	UCN1	127	GND
	102	PL6/ADEND		128	GND
	103	3Vcc		129	GND
	104	PL5/_ADTRG1		130	PK11/TO8L
	105	3Vcc		131	GND
	106	PL4/_ADTRG0		132	PK10/TO8K
	107	3Vcc		133	GND
	108	GND		134	PK9/TO8J
	109	3Vcc		135	GND
	110	PL3/TCLKB		136	PK8/TO8I
	111	5Vcc		137	N.C.
	112	PL2/TIO11B/_IRQ7		138	GND
	113	5Vcc		139	N.C.
	114	PL1/TIO11A/_IRQ6		140	PK7/TO8H
	115	5Vcc		141	N.C.
	116	PL0/TI10		142	PK6/TO8G
	117	5Vcc		143	N.C.
	118	GND		144	PK5/TO8F
	119	5Vcc		145	N.C.
	120	PK15/TO8P		146	PK4/TO8E
	121	5Vcc		147	N.C.
	122	PK14/TO8O		148	GND
	123	5Vcc		149	N.C.
	124	PK13/TO8N		150	PK3/TO8D
	125	GND		151	N.C.
	126	PK12/TO8M		152	PK2/TO8C

Table C.2 Pin Arrangement on HS7058EPH60H (cont)

User I/F 1	Pin No.	Signal Name	User I/F 1	Pin No.	Signal Name
UCN1	153	N.C.	UCN1	177	GND
	154	PK1/TO8B		178	GND
	155	GND		179	GND
	156	PK0/TO8A		180	PJ7/TIO2H
	157	GND		181	GND
	158	GND		182	PJ6/TIO2G
	159	GND		183	GND
	160	PJ15/TI9F		184	PJ5/TIO2F
	161	GND		185	GND
	162	PJ14/TI9E		186	PJ4/TIO2E
	163	GND		187	PG3/_IRQ3/ _ADTRG0
	164	PJ13/TI9D		188	GND
	165	GND		189	PG2/_IRQ2/ADEND
	166	PJ12/TI9C		190	PJ3/TIO2D
	167	GND		191	PG1/_IRQ1
	168	GND		192	PJ2/TIO2C
	169	GND		193	PG0/PULS7/HRxD0/ HRxD1
	170	PJ11/TI9B		194	PJ1/TIO2B
	171	GND		195	GND
	172	PJ10/TI9A		196	PJ0/TIO2A
	173	GND		197	GND
	174	PJ9/TIO5D		198	GND
	175	GND		199	GND
	176	PJ8TIO5C		200	GND

Table C.2 Pin Arrangement on HS7058EPH60H (cont)

User I/F 2	Pin No.	Signal Name	User I/F 2	Pin No.	Signal Name
UCN2	1	GND	UCN2	31	PH9/D9
	2	GND		32	CK
	3	GND		33	PH10/D10
	4	GND		34	GND
	5	GND		35	PH11/D11
	6	GND		36	GND
	7	GND		37	GND
	8	GND		38	GND
	9	PH0/D0		39	PH12/D12
	10	FWE		40	GND
	11	PH1/D1		41	PH13/D13
	12	MD2		42	GND
	13	PH2/D2		43	PH14/D14
	14	MD1		44	GND
	15	PH3/D3		45	PH15/D15
	16	MD0		46	GND
	17	GND		47	GND
	18	GND		48	Vcc
	19	PH4/D4		49	GND
	20	EXTAL		50	Vcc
	21	PH5/D5		51	GND
	22	GND		52	Vcc
	23	PH6/D6		53	GND
	24	_RES		54	PVcc1
	25	PH7/D7		55	GND
	26	GND		56	PVcc1
	27	GND		57	GND
	28	_HSTBY		58	PVcc1
	29	PH8/D8		59	GND
	30	GND		60	PVcc2

Table C.2 Pin Arrangement on HS7058EPH60H (cont)

User I/F 2	Pin No.	Signal Name	User I/F 2	Pin No.	Signal Name
UCN2	61	GND	UCN2	90	N.C.
	62	PVcc2		91	GND
	63	AN0		92	N.C.
	64	PVcc2		93	AN12
	65	AN1		94	N.C.
	66	GND		95	AN13
	67	AN2		96	N.C.
	68	GND		97	AN14
	69	AN3		98	N.C.
	70	GND		99	AN15
	71	GND		100	N.C.
	72	GND		101	GND
	73	AN4		102	AVcc
	74	GND		103	AN16
	75	AN5		104	AVcc
	76	GND		105	AN17
	77	AN6		106	AVcc
	78	N.C.		107	AN18
	79	AN7		108	AVcc
	80	NMI		109	AN19
	81	GND		110	AVref
	82	N.C.		111	GND
	83	AN8		112	AVref
	84	N.C.		113	AN20
	85	AN9		114	AVss
	86	N.C.		115	AN21
	87	AN10		116	AVss
	88	N.C.		117	AN22
	89	AN11		118	AVss

Table C.2 Pin Arrangement on HS7058EPH60H (cont)

User I/F 2	Pin No.	Signal Name	User I/F 2	Pin No.	Signal Name
UCN2	119	AN23	UCN2	146	GND
	120	AVss		147	PA2/TIO0C
	121	GND		148	GND
	122	GND		149	PA3/TIO0D
	123	AN24		150	GND
	124	GND		151	GND
	125	AN25		152	GND
	126	_WDTOVF		153	PA4/TIO3A
	127	AN26		154	GND
	128	GND		155	PA5/TIO3B
	129	AN27		156	PB0/TO6A
	130	GND		157	PA6/TIO3C
	131	GND		158	PB1/TO6B
	132	GND		159	PA7/TIO3D
	133	AN28		160	PB2/TO6C
	134	GND		161	GND
	135	AN29		162	PB3/TO6D
	136	GND		163	PA8/TIO4A
	137	AN30		164	GND
	138	GND		165	PA9/TIO4B
	139	AN31		166	PB4/TO7A/ TO8A
	140	GND		167	PA10/TIO4C
	141	GND		168	PB5/TO7B/ TO8B
	142	GND		169	PA11/TIO4D
	143	PA0/TIOA		170	PB6/TO7C/ TO8C
	144	GND		171	GND
	145	PA1/TIOB		172	PB7/TO7D/ TO8D

Table C.2 Pin Arrangement on HS7058EPH60H (cont)

User I/F 2	Pin No.	Signal Name	User I/F 2	Pin No.	Signal Name
UCN2	173	PA12/TIO5A	UCN2	187	PC2/TxD2
	174	GND		188	PB13/SCK0
	175	PA13/TIO5B		189	PC3/RxD2
	176	PB8/TxD3/ TO8E		190	PB14/SCK1/ TCLKB/TI10
	177	PA14/TxD0		191	PC4/_IRQ0
	178	PB9/RxD3/ TO8F		192	PB15/PULS5/ SCK2
	179	PA15/RxD0		193	GND
	180	PB10/TxD4/ HTxD0/TO8G		194	GND (TGBON2)
	181	GND		195	GND
	182	PB11/RxD4/ HRxD0/TO8H		196	GND
	183	PC0/TxD1		197	GND
	184	GND		198	GND
	185	PC1/RxD1		199	GND
	186	PB12/TCLKA/ _UBCTR		200	GND

C.3 Precautions on Connecting the User System

When connecting the evaluation chip board to the user system, note the following:

1. Secure the E6000H station location.

Place the E6000H station and evaluation chip board so that the station to trace cable is not bent or twisted, as shown below. A bent or twisted cable will impose stress on the user interface, leading to connection or contact failure. Make sure that the E6000H station is placed in a secure position so that it does not move and impose stress on the user interface during use.

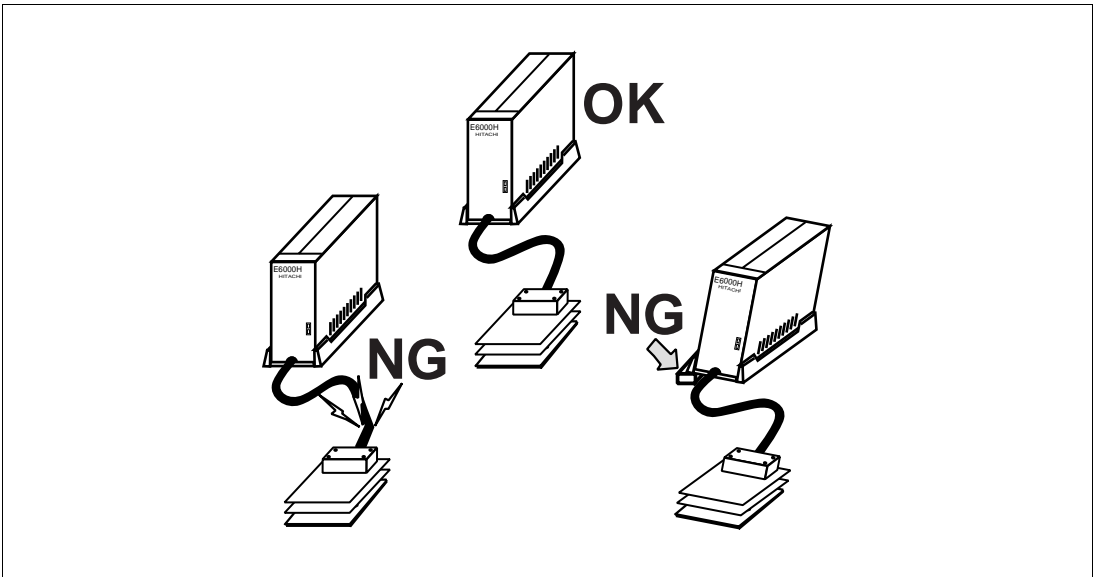

2. Make sure the power supply is off.

Before connecting the evaluation chip board to the user system, check that the emulator and the user system are turned off.

3. Connect the Vcc, PVcc1, and PVcc2 to the user system power.

The emulator monitors and determines whether the user system is turned on or off by the following Vcc pins:

(a) Connecting the dedicated connector for HS7058EPH60H

Vcc: Pins UCN2-48, UCN2-50, and UCN2-52

PVcc1: Pins UCN2-54, UCN2-56, and UCN2-58

PVcc2: Pins UCN2-60, UCN2-62, and UCN2-64

(b) Connecting the user system interface board

Vcc: Pins 11, 49, 52, 75, 139, 187, 203, and 237

PVcc1: Pins 20, 39, 70, and 83

PVcc2: Pins 128, 148, 172, 194, 212, and 247

Accordingly, after connecting the user system to the emulator, be sure to supply power to the Vcc pins. Otherwise, the emulator assumes that the user system is not connected.

When the user system is connected, check that the power of the user system is supplied to these pins.

Appendix D MCU Internal Module Support

D.1 Memory Space

The MCU has a 4-Gbyte memory space in its architecture.

D.1.1 Internal Flash Memory Area

- Access to the internal flash memory area

The emulator includes internal flash memory for the MCU. The internal flash memory is accessed in the mode where the internal flash memory exists. The internal flash memory area access differs between user program execution and the emulator commands.

Only read access is enabled during execution of the user program. A break does not occur if the internal flash memory area is written to.

For access with emulator functions (Memory window or loading), read and write are always enabled.

The internal ROM area is accessed in one state.

D.1.2 Internal I/O Area

If an attempt is made to access the internal I/O area, the internal I/O area in the MCU installed in the emulator is accessed. To break the user program when the internal I/O area is written to or accessed, use the hardware break or internal break.

D.1.3 External Memory Area

The MCU's external memory area can be set with all memory attributes that the emulator supports.

D.1.4 Emulation RAM Area

The emulator includes the emulation RAM (4 kbytes x 8 blocks) for RAM emulation of the internal flash memory. This emulation RAM (ERAM) can be used by overlapping with the internal flash memory address.

If an attempt is made to write the address that overlaps ERAM to the internal flash memory area, the address is written by ERAM and a break does not occur.

D.2 Low Power-consumption Mode (Sleep, Software Standby, and Hardware Standby)

For reduced power consumption, the MCU has sleep, software standby, and hardware standby modes.

D.2.1 Hardware Standby Mode

Since the `_HSTBY` signal from the user system is not input to the MCU in the emulator, the emulator does not support this mode.

D.2.2 Sleep and Software Standby Modes

- Break

The sleep and software standby modes can be cleared with either the normal clearing function or with the break condition satisfaction (forced break), and the program breaks. When restarting after a break, the user program will restart at the instruction following the `SLEEP` instruction.

- Trace

Trace information is not acquired in these modes.

- Memory access with emulator functions

For information on displaying and modifying the contents of memory in the sleep and software standby modes, refer to section E.7, *Displaying and Modifying the Contents of Memory*.

D.3 Interrupts

During execution and step execution, the user can interrupt the MCU.

During halting emulation (break mode), the interrupt source is retained. The mode transits the interrupt processing immediately after emulation is restarted.

D.4 Control Input Signals (`_RES`, `_BREQ`, and `_WAIT`)

The MCU control input signals are `_RES`, `_BREQ`, and `_WAIT`. The `_RES` signal is only valid when emulation has been started with normal program execution (i.e., the `_RES` signal is invalid when emulation has been started with step execution). The `_BREQ` and `_WAIT` signals are valid during emulation with the display and modification of memory contents, execution, and step execution. While emulation is being halted (break), the input of the `_RES`, `_BREQ`, or `_WAIT` signal to the MCU by the user system is not possible.

The input of the `_RES`, `_BREQ`, or `_WAIT` signal during execution or step execution can be disabled by a setting in the [Configuration] dialog box.

D.5 Watchdog Timer (WDT)

While emulation is being halted (during break), counting up the WDT timer counter (TCNT) is suspended, and restarted when emulation is executed again (user mode).

During break mode, a prescaler, which supplies a clock to TCNT, operates continuously. Since the phase of the prescaler may be unmatched before or after emulation transits the break mode, the period before an overflow occurs will differ by ± 1 cycle in the prescaler's clock cycle.

D.6 A/D Converter

The A/D converter has `AVcc`, `AVss`, `Avref`, and `_ADTRG` pins as well as the analog input pins. As the A/D converter operates with an independent power supply, connect `AVcc` (the power supply pin) to the A/D power supply on the user system.

- Notes:
1. When not using the A/D converter, connect `AVcc` to `Vcc`.
 2. As the user system interface cable, printed circuit boards, and protective circuits are connected between the MCU and the user system in the emulator pod, the conversion precision is lower than that of the MCU. At final debugging of the user system using the A/D converter, use the actual SH7058-series F-ZTAT microcomputer chip.

D.7 Emulator Status and Internal Modules

Some internal modules do not operate when the emulator is in break mode. Table D.1 shows the relation between the emulator's state and operation of the internal modules.

Table D.1 Emulator State and Operation of Internal Modules

Internal Module	Operation During Emulation Halted (Break)	Operation During Emulation (Execution or Step Execution)
UBC (user break controller)	No	Yes
DMAC (direct memory access controller)	Yes	Yes
ATU-II (advanced timer unit)	Yes	Yes
APC (advanced pulse controller)	Yes	Yes
WDT (watchdog timer)	No	Yes
CMT (compare-match timer)	Yes	Yes
SCI (serial communication interface)	Yes	Yes
HCAN2 (Hitachi controller area network 2)	Yes	Yes
A/D converter	Yes	Yes
AUD (advanced user debugger)	Yes ¹	Yes ¹
I/O port	Yes	Yes
H-UDI (Hitachi user debugging interface)	Not available ²	Not available ²

Notes: 1. The AUD can be used by the user or the emulator function. Therefore, when the AUD is used by the emulator, it is not available for the user.

2. The user cannot use the H-UDI.

Appendix E Notes on Debugging

E.1 Notes on HDI

E.1.1 Memory Compare Function

The emulator does not support the memory compare function, which is used by selecting [Compare] from the [Memory] menu.

E.1.2 Source-Level Execution

- Step
Even standard C libraries are executed. To return to a caller function, use the step out function. In a for or while statement, executing a single step does not move execution to the next line. To move to the next line, execute a step again.

E.1.3 Watch

- Local variables at optimization
Depending on the generated object code, local variables in a C source file that is compiled with the optimization option enabled will not be displayed correctly. Check the generated object code by displaying the [Disassemble] window.
- Variable name specification
When a name other than a variable name, such as a symbol name or function name, is specified, no data is displayed.
Example: The function name is main.
 main =
- Array display
When array elements exceed 1000, elements from after 1000 will not be displayed.

E.1.4 Symbol Description for Expression

When a symbol of the following condition is described in an expression, enclose the symbol name with '{' and '}'.

- When a symbol is defined by a load module and the symbol name includes a space.

Example: {func(short, long)}

- When a symbol is registered in the [Labels] window and the symbol name includes a character other than alphanumeric characters.

Example: {ASM_DATA1[10]}

E.1.5 Register Function

The default input radix in the [Register] dialog box is hexadecimal irrespective of the radix setting. When a radix other than a hexadecimal is input, specify the prefix code such as B'.

E.1.6 Session File Function

When the [Load last session on startup] check box in the [HDI Options] dialog box is valid and the HDI is activated, loading the session file can be stopped by clicking the [Stop] button during HDI activation.

E.1.7 Command Line Window

- Command file

To display the message “Not currently available” while executing a command file, enter the sleep command. Adjust the sleep time length which differs according to the operating environment.

Example: To display “Not currently available” during MEMORY_FILL command execution:

```
sleep d'3000
memory_fill 0 ffff 0
```

- Overwriting a file

A file having the same name as the output file is overwritten without asking the user.

- File specification by commands

The current directory may be altered by file specifications in commands. Absolute paths are recommended to be used to specify the files in a command file so that the current directory alteration is not affected.

Example: `FILE_LOAD C:\\HEW\\ E6000H\\SH7058\\TUTORIAL\\TUTORIAL.ABS`

E.1.8 [I/O Registers] Window

- Watchdog timer

For each watchdog timer register, there are two registers to be separately used for write and read operations.

Table E.1 Watchdog Timer Registers

Abbreviation	Read/Write	Register
TCNT_W	Write	Watchdog timer counter
TCNT_R	Read	Watchdog timer counter
TCSR_W	Write	Watchdog timer control/status register
TCSR_R	Read	Watchdog timer control/status register
RSTCSR_W	Write	Reset control/status register
RSTCSR_R	Read	Reset control/status register

E.1.9 Bit Field

The internal I/O-register definition file (SH7058.IO) provided with the emulator does not define bit fields. The bit unit cannot be changed in the [I/O Registers] window. When a bit-field definition is added to the I/O register file, the bit unit can be changed. For details, refer to appendix E of the Hitachi Debugging Interface User's Manual provided on the CD-R.

E.1.10 Line Assembly

Regardless of the radix setting, the default for line assembly input is decimal. Specify H' or 0x as the radix for a hexadecimal input.

E.1.11 Usage with Another HDI

- Automatic load of session files

If automatic load of session files is active in an environment with another HDI installed, the following error message is displayed when initiating this HDI and the program is not linked up.

```
invalid target system: <recently used debugging platform name>
```

In this case, change the target session file from [File] - [New Session...] or the [Load Session...] menu.

- Uninstallation of another HDI

If another version of HDI is uninstalled after this HDI has been installed, the [Auto update Memory] and stack trace functions can not be used. In this case, reinstall this HDI.

E.1.12 Operation During Accessing Files

Do not perform other operations during saving in the [Load Program], [Verify Memory], [Save Memory], or [Trace] window because this will not allow correct saving to be performed.

E.1.13 Moving Source File Position after Creating Load Module

When the source file is moved after creating the load module, the [Open] dialog box may be displayed to specify the source file during the debugging of the created load module. Select the corresponding source file and click the [Open] button.

E.2 User System Interface

The delay time is generated on the timing of the $\overline{\text{RES}}$ signal when it is input to the MCU from the user system, as shown in table E.2, because this connection for this signal is via logic circuit on the evaluation chip board.

Table E.2 Delay Time for Signal Connected via the Evaluation Chip Board

Signal Name	Delay Time (ns)
$\overline{\text{RES}}$	15.0

E.3 On-Emulator Break Functions

E.3.1 Setting Address Bus and Data Bus Conditions

The address bus and data bus conditions are satisfied on bus cycles where the values on the address bus or data bus match. Consider the following points when setting these conditions.

- Longword access
Longword data is read and written in single bus cycles. A data condition is only valid for longword access when specified as longword. An address condition is only valid for a longword-access cycle when specified as a multiple of four.
- Word access
Word data is read and written in single bus cycles. A data condition is only valid for word access when specified as word. Any multiple of two is a valid address condition.
- Byte access
Byte data is read and written in single bus cycles. A data condition is only valid for byte access when specified as byte. Any address condition, whether an even or odd number, is valid.

E.4 Sequential Trace Function

1. Six or more external bus cycles are required between each address condition that is specified for each channel.
2. When a user program is executed with the address of a PC address condition specified, a sequential break or a sequential trace stop may not operate correctly. Specify the address of the instruction following the address condition as the PC for the start of the execution, then execute the user program.

E.5 Differences between the Emulator and the MCU

1. Note that the emulator initializes some general or control registers whenever the system is activated or the MCU is reset by commands.

Table E.3 Initial Values of Registers in the MCU and the Emulator

Register Name	Emulator		MCU (Power-On Reset)
	Power On	Reset (Reset CPU)	
PC	Power-on reset vector PC value	Power-on reset vector PC value	Power-on reset vector PC value
R0 to R14	H'00000000	Value before reset	Undefined
R15 (SP)	Power-on reset vector SP value	Power-on reset vector SP value	Power-on reset vector SP value
SR	H'000000F0	H'000000F0	H'00000XFX*
GBR	H'00000000	Value before reset	Undefined
VBR	H'00000000	H'00000000	H'00000000
MACH	H'00000000	Value before reset	Undefined
MACL	H'00000000	Value before reset	Undefined
PR	H'00000000	Value before reset	Undefined

Note: X indicates an undefined value.

2. There is a delay on these signals since the user system interface circuit in the emulator includes pull-up resistors and buffers. Due to the pull-up resistors, the signals can be at a high level even when they are also in their high-impedance state. Take these points into account when preparing hardware for the user system. For details on the user system interface and the delays on signals, see appendix A, User System Interface Circuit.

E.6 Step Function

During step execution, all break conditions are disabled.

E.7 Displaying and Modifying the Contents of Memory

E.7.1 Suspension of Program Execution: Reference Periods

Table E.4 shows the reference value for displaying and modifying the memory contents during user program execution.

Table E.4 Suspension of Program Execution: Reference Values

Method of Access	Condition	Period Suspended
Parallel access	Read Reading a longword from the internal RAM	320 ns
	Write Writing a longword to the internal RAM	320 ns
Auto update Memory	Execution of the user program does not stop	

Table E.5 shows the environment in which these measurements were obtained.

Table E.5 Measurement Environment

Item	Setting
System clock (ϕ)	10.0 MHz
Clock mode	Clock mode 3
H-UDI clock	5.0 MHz

E.7.2 Parallel Access

The display of memory cannot be updated or modified by parallel access during standby mode.

E.7.3 External Memory Area Access in Single-Chip Mode

In single-chip mode, do not access the external memory area (display or modify the memory contents) within the range of H'00200000 to H'7FFFFFFF in the memory window. An address error will occur.

Appendix F Diagnostic Test Procedure

This section describes the diagnostic test procedure using the E6000H diagnostic program.

F.1 System Set-Up for Diagnostic Program Execution

To execute the diagnostic program, use the following hardware; do not connect the user system interface board and user system.

- E6000H (HS7058EPH60H)
 - Host computer
 - The E6000 PC interface board which will be one of the following boards:
 - PCI bus interface board (HS6000EIC01H or HS6000EIC02H)
 - PC card interface (HS6000EIP01H)
 - LAN adapter (HS6000ELN01H)
 - USB adapter (HS6000EIU01H)
1. Install the E6000 PC interface board in the host computer and connect the supplied PC interface cable to the board.
 2. Connect the PC interface cable to the E6000H.
 3. Connect the supplied AC power cable to the E6000H.
 4. Initiate the host computer to make it enter the command input wait state of the DOS prompt (Windows[®] 98 or Windows[®] Me) or command prompt (Windows NT[®], Windows[®] 2000, or Windows[®] XP). If the property of the prompt window is not a mode for displaying the whole screen, press the [Alt + Enter] key to switch the mode. To set back the mode, press the [Alt + Enter] key. The display of the screen is switched regardless of the OS being used.

Note: In the MS-DOS prompt, if the display of the screen is not switched after pressing the [Alt + Enter] key, mark the [Alt+Enter] check box in [Windows shortcut keys] of the [Misc] page on the [MS-DOS Prompt Properties] dialog box and click the [Apply] button to update the settings.

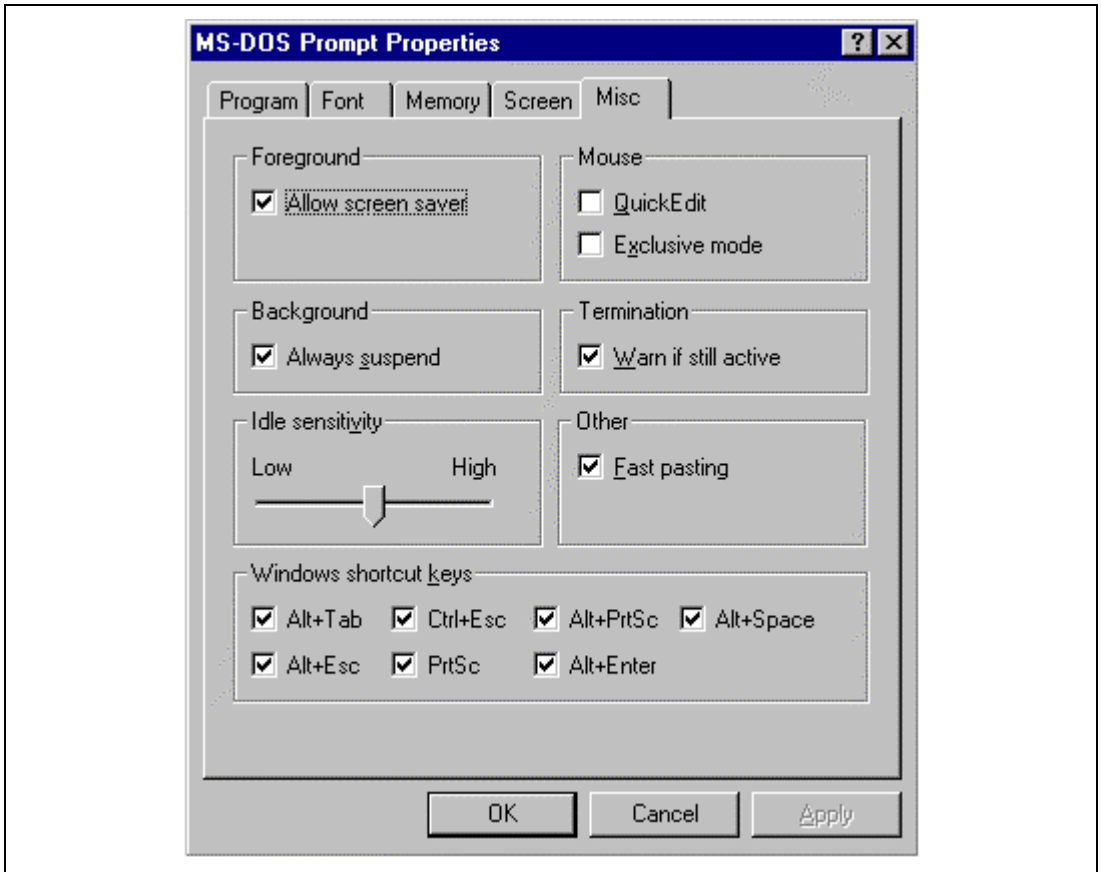

Figure F.1 [Misc] Page

5. Turn on the E6000H emulator switch.

Note: To execute the diagnostic program, firstly turn on the power of the emulator. In the diagnostic program, the initial state of hardware is checked. Therefore, after the power is turned on, do not activate the HDI before executing the diagnostic program.

F.2 Test Item of the Diagnostic Program

Table F.1 shows the test items of this diagnostic program.

Test No.	Test Item	Description
1	Main Board Access	Register test in the E6000H main board
2	Emulation Board Access	Register test in the E6000H emulation board
3	Evaluation Chip Board Access	Register test in the E6000H evaluation chip board
4	Basic Function	Test for the basic function
5	GO to BREAK Time Measurement	Test for the execution time measurement function
6	Emulation Monitor	Test for emulation monitor
7	G/A Break Function	Test for the G/A break function
8	G/A Performance Analysis Function	Test for the G/A performance measurement function
9	G/A Monitor Function	Test for the G/A monitoring function
10	G/A Parallel RAM Monitor	Test for the G/A parallel RAM monitoring function
11	G/A Trace Function	Test for the G/A trace function
12	Combination	Test for combination of each function
13	Parallel Access	Test for the parallel access function

F.3 Diagnostic Test Procedure Using the Diagnostic Program

Insert the CD-R (HS7058EPH60SR supplied with the E6000H) into the CD-ROM drive of the host computer by pressing the Shift key, move the current directory to <Drive>:\Diag with a command prompt, and enter one of the following commands according to the PC interface board used to initiate the diagnostic program:

1. PCI bus interface board (HS6000EIC01H or HS6000EIC02H)
> TM7058 -PCI (RET)
2. PC card interface (HS6000EIP01H)
> TM7058 -PCCD (RET)
3. LAN adapter (HS6000ELN01H)
> TM7058 -ELN (RET)
4. USB adapter (HS6000EIU01H)
> TM7058 -USB (RET)

The HDI must be installed before the test program is executed.

Be sure to initiate the diagnostic program from <Drive>:\Diag. Do not initiate it from a directory other than <Drive>:\Diag, such as > <Drive>:\Diag\TM7058 -PCI (RET). If the diagnostic program is initiated when the current directory is not <Drive>:\Diag, the diagnostic program will not operate correctly.

When -S is added to the command line such as > TM7058 -PCI -S (RET), steps 1 to 13 will be repeatedly executed. To stop the execution, enter Q.

- Notes:
1. When the CD-R is inserted into the CD-ROM drive without pressing the Shift key, the HDI installation wizard is automatically started. In such a case, exit the HDI installation wizard.
 2. <Drive> is a drive name for the CD-ROM drive.
 3. Do not remove the CD-R from the CD-ROM drive during test program execution.

The following messages are displayed during the test. There are 13 steps in this test (when 166-MHz host computer and Windows[®] 98 PCI interface board are used, the time for the test will be about three minutes).

Message	Description
E6000H SH7058 Emulator Tests Vx.x Copyright (c) 2002 Hitachi Ltd.	Test program start message. x.x shows the version number.
Loading driverOK (Use PCI)	Shows that the PC interface board is correctly installed in the host computer.
Initializing driverOK	
Searching for interface cardOK	
Checking emulator is connectedOK	Shows that the E6000H emulator is correctly connected to the host computer.
Emulator board information: Main board ID: H'0 Emulation board ID: H'001	Shows the ID number of the E6000H emulator.
Normal started at Tue Jul 16 20:47:41 2002	Shows the time when the diagnostic program has started.
***** NORMAL TEST - Press 'Q' to stop ***** 1. Main Board Access 01) Registers Initial Value CheckOK 02) Registers Write/VerifyOK 03) DPRAM Address Decode TestSKIP 04) DPRAM Marching TestSKIP 05) Trace Memory Address Decode TestOK 06) Trace Memory Marching TestOK 07) G/A Registers Initial Value CheckOK 08) G/A Registers Write/VerifyOK 2. Emulation Board Access 01) Registers Initial Value CheckOK 02) Registers Write/VerifyOK 03) H-UDI Interface Registers Initial Value CheckOK 04) H-UDI Interface Registers Write/VerifyOK 05) AUD Interface Registers Initial Value CheckOK 06) AUD Interface Registers Write/VerifyOK	(COUNT=0001)

```

07) AUD Interface Registers Address Decode Test .....OK
3. Evaluation Board Access
01) Registers Initial Value Check .....OK
02) Registers Write/Verify .....OK
03) H-UDI IDCODE Check .....OK
04) Firmware BOOT .....OK
05) Configuration Set .....OK
4. Basic Function
01) GO to BREAK .....OK
02) RESET GO .....OK
03) STEP .....OK
04) KEYBREAK .....OK
05) BRKCONT .....OK
5. GO to BREAK Time Measurement
01) Counter Test Mode .....OK
02) EMU 5MHz MPU 20MHz Sampling 20ns (Default) .....OK
03) EMU 5MHz MPU 20MHz Sampling 1.6u .....OK
04) EMU 5MHz MPU 20MHz Sampling 52u .....OK
05) EMU 10MHz MPU 40MHz Sampling MPU .....OK
06) EMU 10MHz MPU 40MHz Sampling MPU/2 .....OK
07) EMU 10MHz MPU 40MHz Sampling MPU/4 .....OK
08) EMU 5MHz MPU 20MHz Sampling 20ns .....OK
09) EMU 10MHz MPU 80MHz Sampling 20ns .....OK
6. Emulation Monitor
01) AUDRES .....OK
02) TRES .....OK
03) ASEST1 - 0 .....OK
04) VCC3VNG .....OK
05) VCC2-5VNG .....OK
06) VCC1-NG .....OK
7. G/A Break Function
01) Address Condition .....OK
02) Data Condition .....OK
03) Control Signal Condition (ASEDSHH/HL/LH/HL) .....OK
04) Function Code Condition (ASEBM1 ASEAS2-0) .....OK
05) Control Signal Condition (ASEAS2-1) .....OK
06) Control Signal Condition (ASEIF-N) .....OK
07) Control Signal Condition (ASEERAM-N) .....OK
08) Control Signal Condition (/DMA_AUD ASEBM0) .....OK
09) Control Signal Condition (ASEST1-0) .....OK
8. G/A Performance Analysis Function
01) Time Measurement (20ns Sampling) .....OK
9. G/A Monitor Function
01) STEP/RUN .....OK
02) VCCDOWN .....OK
03) NOCLK .....OK
04) TIMEOUT .....OK
10. G/A Parallel RAM Monitor
01) PRAM Monitor (BYTE) .....OK
02) PRAM Monitor (WORD) .....OK
03) PRAM Monitor (LONG WORD) .....OK
11. G/A Trace Function
01) Free Trace .....OK
02) Trace Stop .....OK
03) Time Stamp .....OK
04) Trace Suppress .....OK
12. Combination
01) B to A Time Measurement( FPGA counter ) .....OK

```

```

02) B to A Time Measurement( G/A counter ) .....OK
03) D to C Time Measurement( G/A counter ) .....OK
13. Parallel Access
01) AUD Write (INROM BYTE) .....OK
02) AUD Write (INROM WORD) .....OK
03) AUD Write (INROM LONGWORD) .....OK
04) AUD Write (INRAM BYTE) .....OK
05) AUD Write (INRAM WORD) .....OK
06) AUD Write (INRAM LONGWORD) .....OK
07) AUD Sample (INROM BYTE) .....OK
08) AUD Sample (INROM WORD) .....OK
09) AUD Sample (INROM LONGWORD) .....OK
10) AUD Sample (INRAM BYTE) .....OK
11) AUD Sample (INRAM WORD) .....OK
12) AUD Sample (INRAM LONGWORD) .....OK
13) AUD Sample 256point .....OK

```

Normal stopped at Tue Jul 16 20:50:18 2002

Shows the time when the diagnostic program has ended.

Tests run for 0H:2M:37S

Shows the execution time of the diagnostic program.

Summary:

Tests performed 1 time(s).

```

1. Main Board Access : 0 Error(s)
2. Emulation Board Access : 0 Error(s)
3. Evaluation Board Access : 0 Error(s)
4. Basic Function : 0 Error(s)
5. GO to BREAK Time Measurement : 0 Error(s)
6. Emulation Monitor : 0 Error(s)
7. G/A Break Function : 0 Error(s)
8. G/A Performance Analysis Function : 0 Error(s)
9. G/A Monitor Function : 0 Error(s)
10. G/A Parallel RAM Monitor : 0 Error(s)
11. G/A Trace Function : 0 Error(s)
12. Combination : 0 Error(s)
13. Parallel Access : 0 Error(s)

```

Shows the total of the number of errors occurred in each test item.

