

Digital Temperature Controllers E5AN

Compact and Intelligent Temperature Controllers

- Depth of only 78 mm.
- Various temperature inputs: thermocouple, platinum resistance thermometer, infrared temperature sensor, and analog inputs.
- Auto-tuning and self-tuning available. Auto-tuning is possible even while self-tuning is being executed.
- Heating or heating/cooling control is available.
- Event input allows multiple SP selection and run/stop function.
- Water-resistant construction (NEMA4X: equivalent to IP66).
- Conforms to UL, CSA, and IEC safety standards as well as CE marking.



96(W) x 96(H) x 78(D) mm



Model Number Structure

Model Number Legend

E5AN- M -500
1 2 3 4 5

1. Output type

- R: Relay
- Q: Voltage (for driving SSR)
- C: Current

2. Number of alarms

- 3: Three alarms

3. Heater burnout alarm

- Blank: Not available
- H: Available

4. Option Unit

- M: Option Unit can be mounted

5. Input type

- TC: Thermocouple
- P: Platinum resistance thermometer

Ordering Information

Standard Models

Size	Power supply voltage	No. of alarm points	Control output	Heater burnout alarm	Thermocouple model	Platinum resistance thermometer model
1/4 DIN 96(W) x 96(H) x 78(D) mm	100 to 240 VAC	3	Relay	No	E5AN-R3MTC-500	E5AN-R3MP-500
				Yes	E5AN-R3HMTC-500	E5AN-R3HMP-500
			Voltage (for driving SSR)	No	E5AN-Q3MTC-500	E5AN-Q3MP-500
				Yes	E5AN-Q3HMTC-500	E5AN-Q3HMP-500
			Current	No	E5AN-C3MTC-500	E5AN-C3MP-500
				Yes	E5AN-C3HMTC-500	E5AN-C3HMP-500
	24 VAC/VDC	3	Relay	No	E5AN-R3MTC-500	E5AN-R3MP-500
				Yes	E5AN-R3HMTC-500	E5AN-R3HMP-500
			Voltage (for driving SSR)	No	E5AN-Q3MTC-500	E5AN-Q3MP-500
				Yes	E5AN-Q3HMTC-500	E5AN-Q3HMP-500
			Current	No	E5AN-C3MTC-500	E5AN-C3MP-500
				Yes	E5AN-C3HMTC-500	E5AN-C3HMP-500

Note 1. A Current Transformer (CT) is not provided with the Unit. If using a heater burnout alarm, be sure to order one when ordering the E5AN.
2. When the heating and cooling function or the heater burnout alarm is used, one of the alarm outputs will be disabled for each function used.
3. Specify the power supply specifications when ordering.

Temperature Controller

■ Option Units

The E5AN provides communication or event input functionality when mounted with one of the following Option Units.

Name	Model	Function
Communication Unit	E53-AK01	RS-232C communication
	E53-AK03	RS-485 communication
Event Input Unit	E53-AKB	Event input

■ Current Transformer (Sold Separately)

Model	E54-CT1	E54-CT3
Hole diameter	5.8 dia.	12.0 dia.

■ Terminal Cover

Model	E53-COV11
-------	-----------

Note: The Terminal Cover comes with the E5AN and does not have to be purchased separately.

Specifications

■ Ratings

Supply voltage	100 to 240 VAC, 50/60 Hz	24 VAC, 50/60 Hz/24 VDC
Operating voltage range	85% to 110% of rated supply voltage	
Power consumption	9 VA	5 VA/4 W
Sensor input	Thermocouple: K, J, T, E, L, U, N, R, S, B Platinum resistance thermometer: Pt100, JPt100 Infrared temperature sensor: 10 to 70°C, 60 to 120°C, 115 to 165°C, 160 to 260°C Voltage input: 0 to 50 mV	
Control output	Relay output	SPST-NO, 250 VAC, 5 A (resistive load), electrical life: 100,000 operations
	Voltage output	12 VDC ^{+15%} / _{-20%} (PNP), max. load current: 40 mA, with short-circuit protection circuit
	Current output	4 to 20 mA DC, load: 600 Ω max., resolution: approx. 2,600
Alarm output	SPST-NO, 250 VAC, 3 A (resistive load), electrical life: 100,000 operations	
Control method	2-PID or ON/OFF control	
Setting method	Digital setting using front panel keys	
Indication method	7-segment digital display and single-lighting indicator Character height: PV: 15.0 mm; SV: 9.5 mm	
Other functions	According to Controller model	
Ambient temperature	-10 to 55°C (with no condensation or icing)	
Ambient humidity	25% to 85%	
Storage temperature	-25 to 65°C (with no condensation or icing)	

Input Ranges

Platinum Resistance Thermometer Input/Thermocouple Input

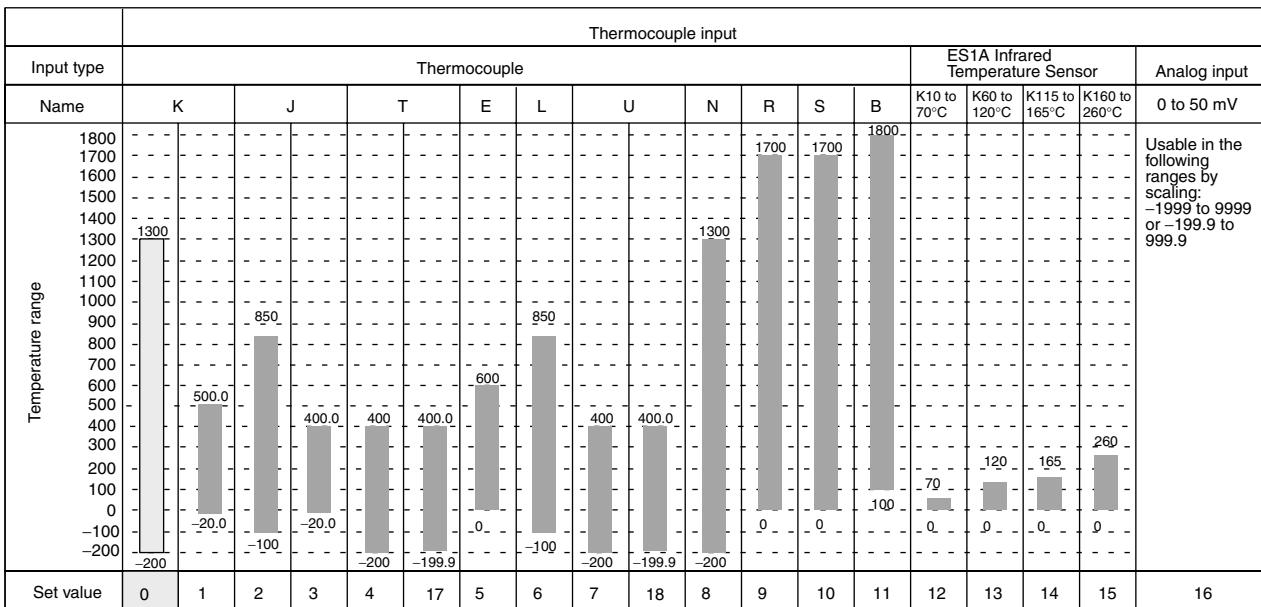
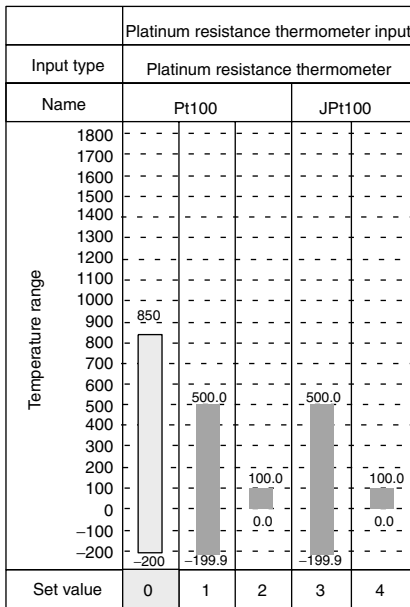

Applicable standards by input type are as follows:

- K, J, T, E, N, R, S, B: JIS C1602-1995
- L: Fe-CuNi, DIN 43710-1985
- U: Cu-CuNi, DIN 43710-1985
- JPt100: JIS C1604-1989, JIS C1606-1989
- Pt100: JIS C1604-1997, IEC751

Shaded ranges indicate default settings.

ES1A models with a temperature range of 160°C to 260°C have been discontinued.

■ Characteristics

Indication accuracy	Thermocouple: (±0.5% of indicated value or ±1°C, whichever greater) ±1 digit max. (see note) Platinum resistance thermometer: (±0.5% of indicated value or ±1°C, whichever greater) ±1 digit max. Analog input: ±0.5% FS±1 digit max. CT input: ±5% FS±1 digit max.	
Hysteresis	0.1 to 999.9 EU (in units of 0.1 EU)	
Proportional band (P)	0.1 to 999.9 EU (in units of 0.1 EU)	
Integral time (I)	0 to 3999 s (in units of 1 s)	
Derivative time (D)	0 to 3999 s (in units of 1 s)	
Control period	1 to 99 s (in units of 1 s)	
Manual reset value	0.0% to 100.0% (in units of 0.1%)	
Alarm setting range	-1999 to 9999 (decimal point position depends on input type)	
Sampling period	500 ms	
Insulation resistance	20 MΩ min. (at 500 VDC)	
Dielectric strength	2000 VAC, 50 or 60 Hz for 1min (between different charging terminals)	
Vibration resistance	10 to 55 Hz, 10 m/s ² for 2 hours each in X, Y and Z directions	
Shock resistance	300 m/s ² , 3 times each in 3 axes, 6 directions (relay: 100 m/s ²)	
Weight	Approx. 310 g	Mounting bracket: Approx. 60 g
Degree of protection	Front panel: NEMA4X for indoor use (equivalent to IP66), rear case: IP20, terminals: IP00	
Memory protection	EEPROM (non-volatile memory) (number of writes: 100,000)	
EMC	Emission Enclosure: EN55011 Group 1 class A Emission AC Mains: EN55011 Group 1 class A Immunity ESD: EN61000-4-2: 4 kV contact discharge (level 2) 8 kV air discharge (level 3) Immunity RF-interference: ENV50140: 10 V/m (amplitude modulated, 80 MHz to 1 GHz) (level 3) 10 V/m (pulse modulated, 900 MHz) Immunity Conducted Disturbance: ENV50141: 10 V (0.15 to 80 MHz) (level 3) Immunity Burst: EN61000-4-4: 2 kV power-line (level 3) 2 kV I/O signal-line (level 4)	
Approved standards	UL3121-1, CSA22.2 No. 142, E.B.1402C Conforms to EN50081-2, EN50082-2, EN61010-1 (IEC61010-1) Conforms to VDE0106/part 100 (Finger Protection), when the terminal cover is mounted.	

Note: The indication of K thermocouples in the -200 to 1300°C range, and T and N thermocouples at a temperature of -100°C or less, and U and L thermocouples at any temperature is ±2°C±1 digit maximum. The indication of B thermocouples at a temperature of 400°C or less is unrestricted.
The indication of R and S thermocouples at a temperature of 200°C or less is ±3°C±1 digit maximum.

■ Communications Specifications

Transmission path connection	RS-485: Multiple points RS-232C: Point-to-point
Communications method (see note 1)	RS-485 (two-wire, half duplex)/RS-232C
Synchronization method	Start-stop synchronization
Baud rate	1,200/2,400/4,800/9,600/19,200 bps
Transmission code	ASCII
Data bit length (see note 2)	7 or 8 bits
Stop bit length (see note 2)	1 or 2 bits
Error detection	Vertical parity (none, even, odd) Frame check sequence (FCS): with SYSWAY Block check character (BCC): with CompoWay/F
Flow control	Not available
Interface (see note 1)	RS-485/RS-232C
Retry function	Not available
Communications buffer	40 bytes

Note 1. RS-232C communications are only supported for the E5AN and E5EN models.

2. The baud rate, data bit length, stop bit length, or vertical parity can be individually set using the communications setting level.

Current Transformer (Sold Separately) Ratings

Dielectric strength	1,000 VAC (1 min)
Vibration resistance	50 Hz 98 m/s ²
Weight	E54-CT1: Approx. 11.5 g E54-CT3: Approx. 50 g
Accessories (E54-CT3 only)	Armature (2) Plug (2)

Heater Burnout Alarm Specifications

Max. heater current	Single-phase AC: 50 A (see note 1)
Input current readout accuracy	±5%FS±1 digit max.
Heater burnout alarm setting range	0.0 to 50.0 A (0.1 A units) (see note 2)
Min. detection ON time	190 ms (see note 3)

- Note 1.** When heater burnout is detected on a 3-phase heater, use the K2CU-F□□A-□GS (with gate input terminal).
2. When the set value is "00 A," the heater burnout alarm will always be OFF. When the set value is "50.0 A," the heater burnout alarm will always be ON.
3. When the control output ON time is less than 190 ms, heater burnout detection and heater current measurement will not be carried out.

Engineering Data

Electrical Life Expectancy Curve for Relays (Reference Values)

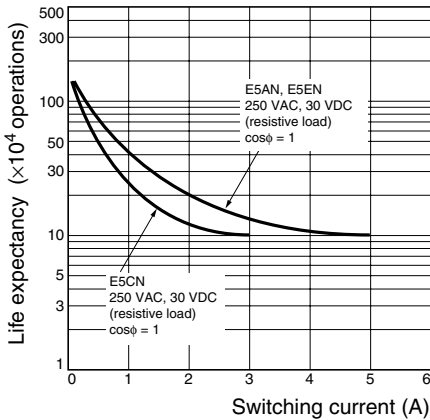

E54-CT1

Thru-current (Io) vs. Output Voltage (Eo) (Reference Values)

Maximum continuous heater current: 50 A (50/60 Hz)
 Number of windings: 400±2
 Winding resistance: 18±2 Ω

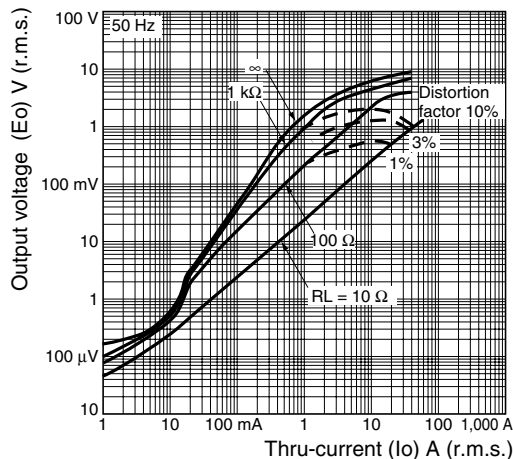

Temperature Controller

E54-CT3

Thru-current (Io) vs. Output Voltage (Eo) (Reference Values)

Maximum continuous heater current: 120 A (50/60 Hz)
 (Maximum continuous heater current for an OMRON Temperature Controller is 50 A.)
 Number of windings: 400±2
 Winding resistance: 8±0.8 Ω

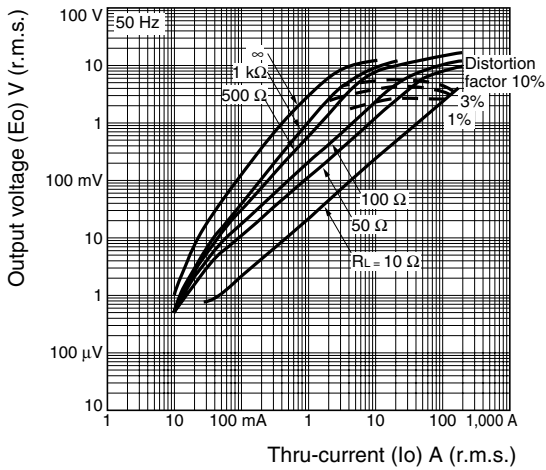

Wiring Terminals

- The voltage output (control output) is not electrically insulated from the internal circuits. When using a grounding thermocouple, do not connect the control output terminals to the ground. If the control output terminals are connected to the ground, errors will occur in the measured temperature values as a result of leakage current.
- Standard insulation is applied to the power supply I/O sections. If reinforced insulation is required, connect the input and output terminals to a device without any exposed current-carrying parts or to a device with standard insulation suitable for the maximum operating voltage of the power supply I/O section.

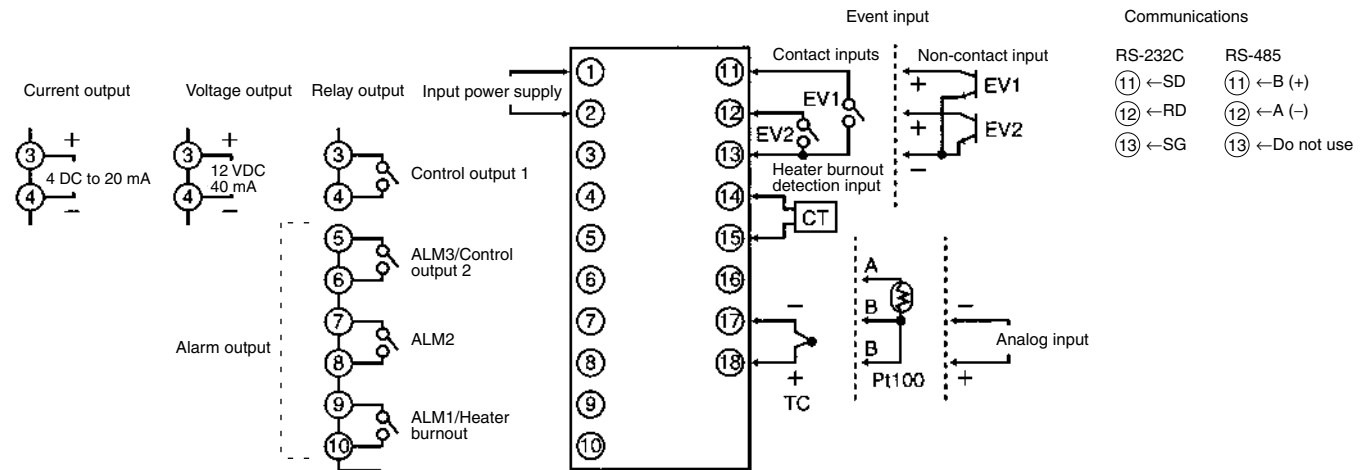

Note: Two input power supplies are available: 100 to 240 VAC or 24 VDC.

Nomenclature

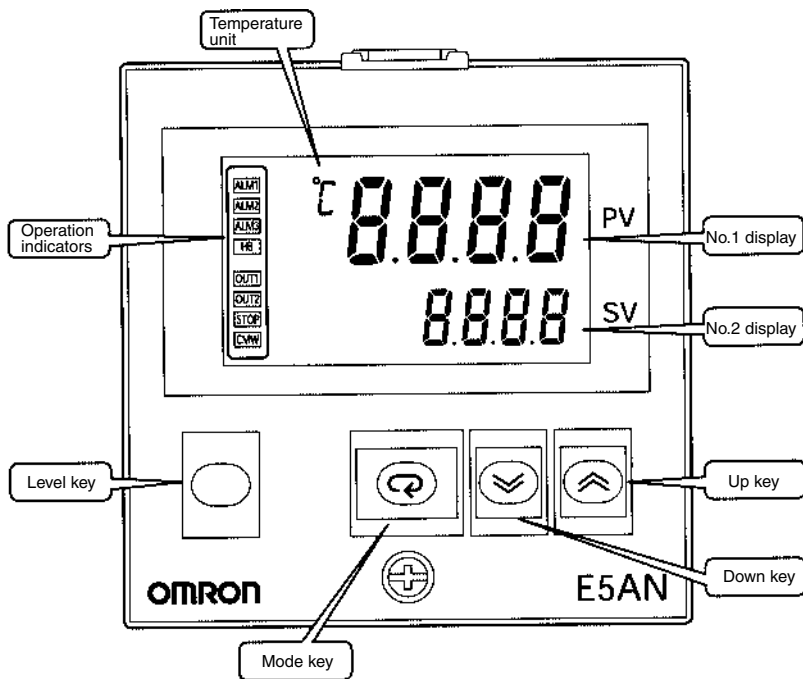

Dimensions

Note: All units are in millimeters unless otherwise indicated.

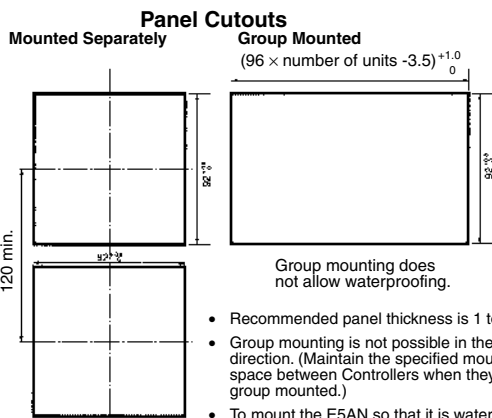
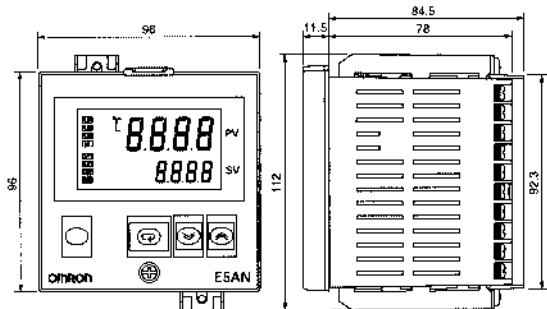
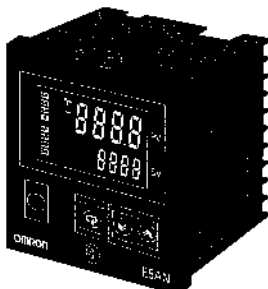

- Group mounting does not allow waterproofing.
- Recommended panel thickness is 1 to 8 mm.
 - Group mounting is not possible in the vertical direction. (Maintain the specified mounting space between Controllers when they are group mounted.)
 - To mount the E5AN so that it is waterproof, apply the waterproof packing to the E5AN.
 - When two or more E5ANs are mounted, make sure that the surrounding temperature does not exceed the allowable operating temperature specified in the specifications.

Temperature Controller

Current Transformer (Sold Separately)

E54-CT1

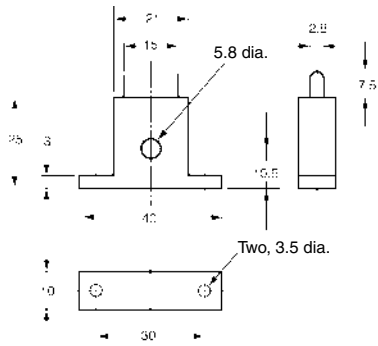
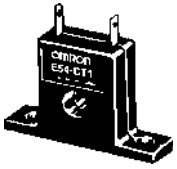

E54-CT3

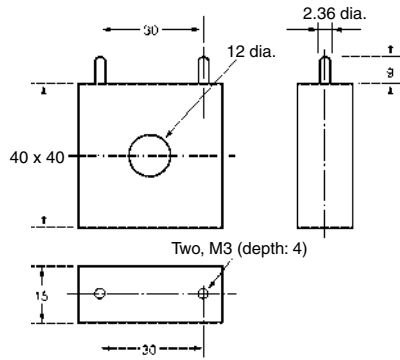

Terminal Cover

E53-COV11

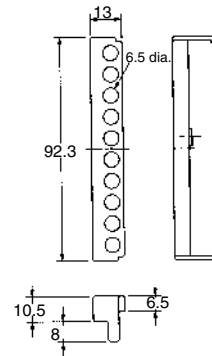
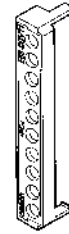

ALL DIMENSIONS SHOWN ARE IN MILLIMETERS.

To convert millimeters into inches, multiply by 0.03937. To convert grams into ounces, multiply by 0.03527.