

DN SERIES-NEW D SUBMINIATURE INTERFACE CONNECTORS

General

The DN series are compact, rectangular multi-contact connectors developed to meet the demand for smaller and slimmer electronic equipment. 2.54 mm grid contact position and Direct dip soldering on PCB enable

high density circuit designing at reduced cost. Aluminum die-cast shell and Metallic shell areshielded to prevent from Electro-Magnetic interference. 20, 26, 36 and 50 way available.

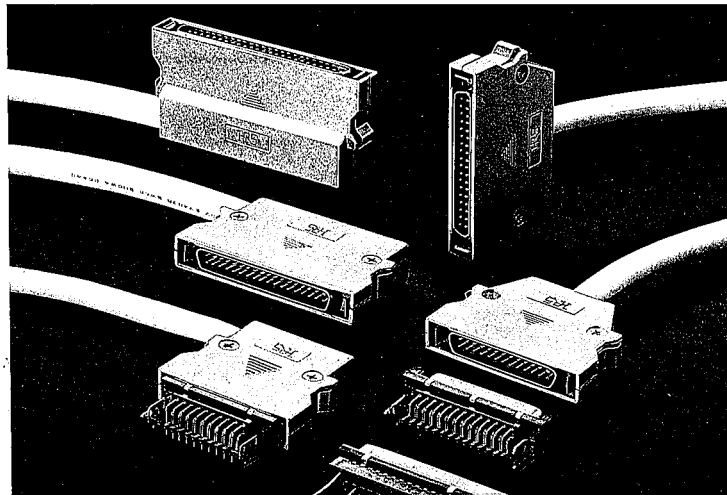

Features

1. 2.54 mm grid contact position enable high density circuit designing.
2. Stable quality due to the contact design based on our field-proven SM series (D sub-connector).
3. One-touch lock system ensures perfect operation.
4. The cover case uses a thin, low-back compact design that meets the needs of high density mounting. It can be mounted between 17.78 millimeters (700mil) substrates.
5. The cover case is made of aluminum diecast to shield against electromagnetic waves. In a combination with a connector metal shell, the cover case is an ideal solution for noise.
6. Dip soldering connectors are provided with snap clamps for temporarily fixing the connector on the PCB.
7. IDC termination types are for standard 1.27 mm pitch cables, and are available for two types of cables: AWG26 and AWG28.
8. Crimp contact cables from AWG26 through AWG28.
9. Allows you to take out the cable vertically or horizontally, as your application requires.

Applications

Office Automation, Computers, Communications Equipment, Factory Automation, Home Automation and other commercial applications needing high density interconnections.

Specifications and Material

Main specifications	
Current capacity	3A
Rated voltage	AC200V
Insulation resistance	5000mΩ or higher at DC 500V
Contact resistance	20mΩ or less at DC 100mA
Withstand voltage	1 minute AC 1000 Vrms

Main materials used		
Shell	Aluminum die-cast	Silver coating
Insulator	PBT *	Black
Contacts	Phosphor bronze	Selective gold plating

* UL94V-0

Ordering Information

DN 10 - 26 S

(1) (2) (3) (4)

DN - 26 - CVE 1

(1) (3) (5)

DN 50 - 2628 PC 1

(1) (2) (6) (7)

- (1) Series Number: DN
- (2) Type
 - 10: Right Angle Dip Type
 - 30: IDC Plug Type
 - 50: Crimp Type
- (3) No. of Pins: 20, 26, 36 and 50 way
- (4) P: Plug
S: Receptacle
- (5) Shell
 - CVE1: Angle Cable Exit Shell
 - CV1: Straight Cable Exit Shell
- (6) Applicable Wire
 - 2628: AWG#26 ~ AWG#28
- (7) Type of Contact Pin
 - PC1: Bulk Pin Contact
 - PC2: Chain Pin Contact

Cable specifications

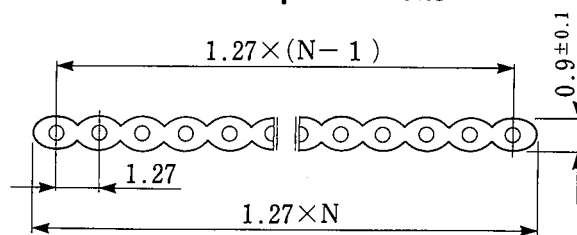

N: Pin

Pin: AWG # 28(7/0.127)
AWG # 26(7/0.16)

Crimp Pin Housing

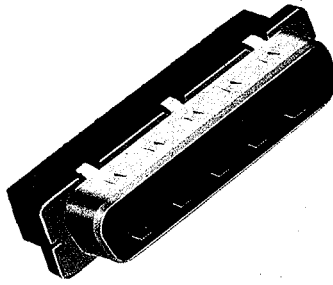

CL225-0004-4
DN50-26P

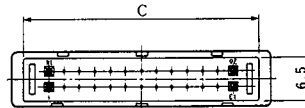
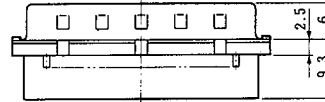
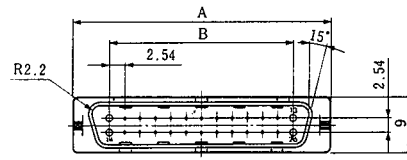

Unit: mm

HRS No.	No. of Pin	Part No.	A	B	C
225-0016-3	20	DN50-20P	35.36	22.86	31.38
225-0004-4	26	DN50-26P	42.98	30.48	39
225-0005-7	36	DN50-36P	55.68	43.18	51.7
225-0006-0	50	DN50-50P	73.46	60.96	69.48

IDC Plug

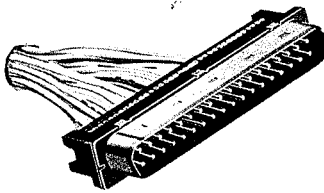

CL225-0027-0
DN30-36P

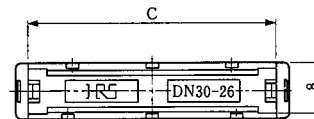
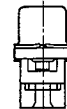
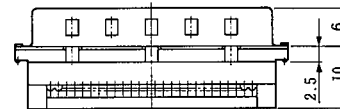
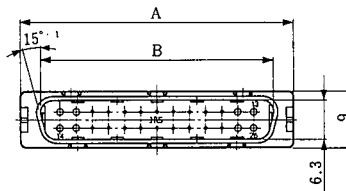

Unit: mm

HRS No.	No. of Pin	Part No.	A	B	C
225-0030-4	20	DN30-20P	35.36	29.1	31.38
225-0029-5	26	DN30-26P	42.98	36.7	39
225-0027-0	36	DN30-36P	55.68	49.4	51.7
225-0028-2	50	DN30-50P	73.46	67.2	69.48

Angle Cable Exit Shell

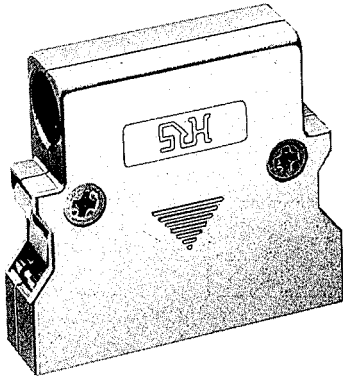

CL225-0020-0
DN-26-CVE1

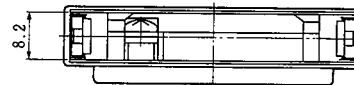
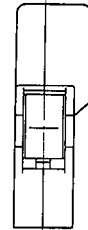
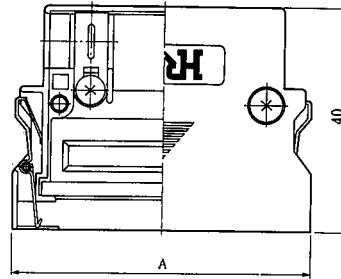
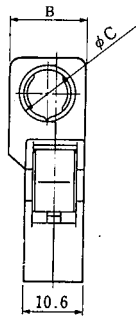

Unit:mm

HRS No.	No. of Pin	Part No.	A	B	C
225-0019-1	20	DN-20-CVE1	45.9	12.7	9
225-0020-0	26	DN-26-CVE1	53.5	13.7	9.7
225-0021-3	36	DN-36-CVE1	66.2	14.2	11
225-0022-6	50	DN-50-CVE1	84	14.2	12X13

Straight Cable Exit Shell

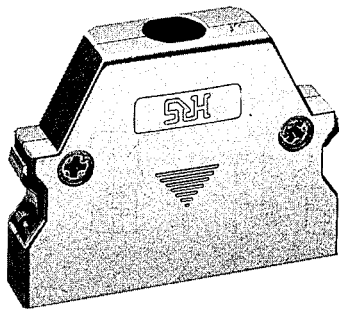

CL225-0024-1
DN-26-CV1

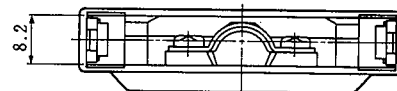
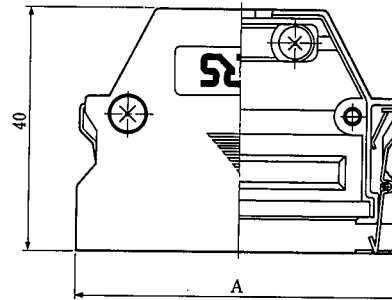
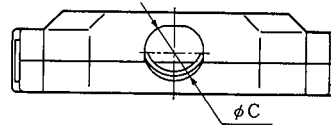
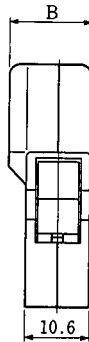

Unit:mm

HRS No.	No. of Pin	Part No	A	B	C
225-0031-7	20	DN-20-CV1	45.9	13.7	9
225-0024-1	26	DN-26-CV1	53.5	13.7	9.7
225-0025-4	36	DN-36-CV1	66.2	14.2	11

Right Angle P.C. Mount Receptacle

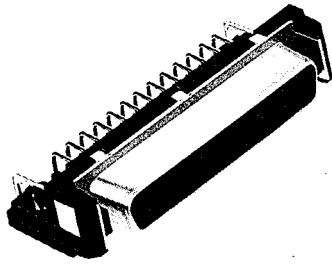

CL225-0001-6
DN10-26S

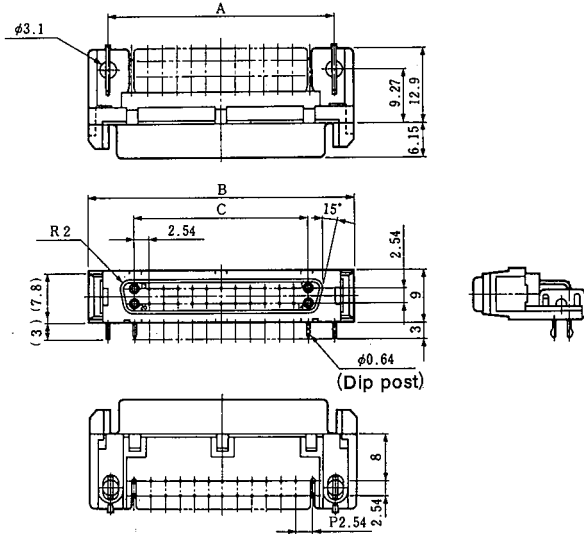

Note 1: Dimensions in () are for reference.

Unit: mm

HRS No.	No. of Pin	Part No.	A	B	C
225-0015-0	20	DN10-20S	32	38.9	22.86
225-0001-6	26	DN10-26S	39.6	46.5	30.48
225-0002-9	36	DN10-36S	52.3	59.2	43.18
225-0003-1	50	DN10-50S	70.1	77	60.96

PCB Layout

mounting panel thickness 1.6mm

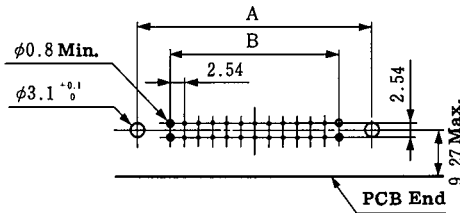

Unit: mm

No. of Pin	20	26	36	50
A	32.0	39.6	52.3	70.1
B	22.86	30.48	43.18	60.96

Straight P.C. Mount Receptacle

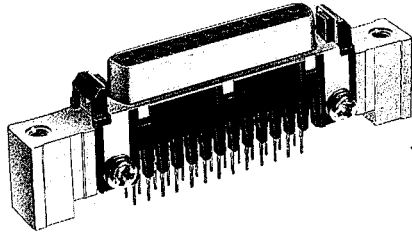

CL225-0046-0
DN20B-26S

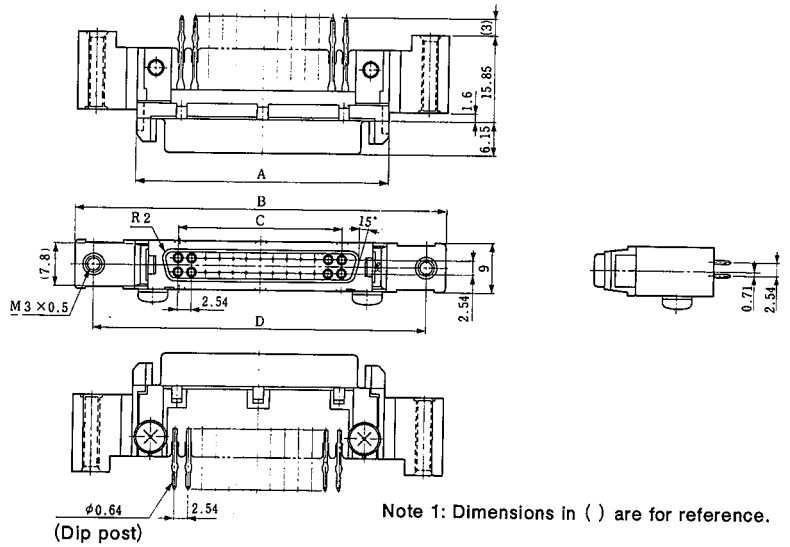

HRS No.	No. of Pin	Part No.	A	B	C	D
225-0045-1	20	DN20B-20S	38.9	60.9	22.86	53.9
225-0046-4	26	DN20B-26S	46.5	68.5	30.48	61.5
225-0047-7	36	DN20B-36S	59.2	81.2	43.18	74.2
225-0048-0	50	DN20B-50S	77	99	60.96	92

PCB Layout

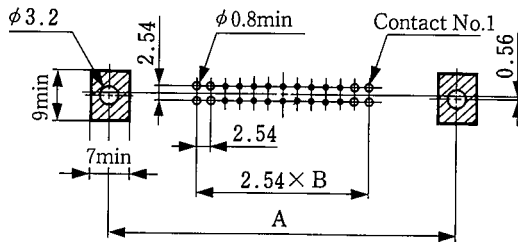

Panel Cutout

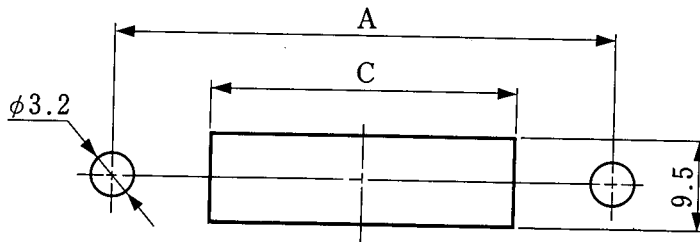

Unit:mm

No. of Pin	A	B	C
20	53.9	9	40.9
26	61.5	12	48.5
36	74.2	17	61.2
50	92	24	79

1. Use a 1.6-mm thick panel
2. The substrate reference drawing shows the connector-mounting surface. The area marked with [] is to be prohibited from entering any pattern.
3. The substrate and panel are related to each other, with a 0/3.2 mounting hole as the reference point.
4. The panel is 1.6 millimeters thick.

Pin Crimp Terminal

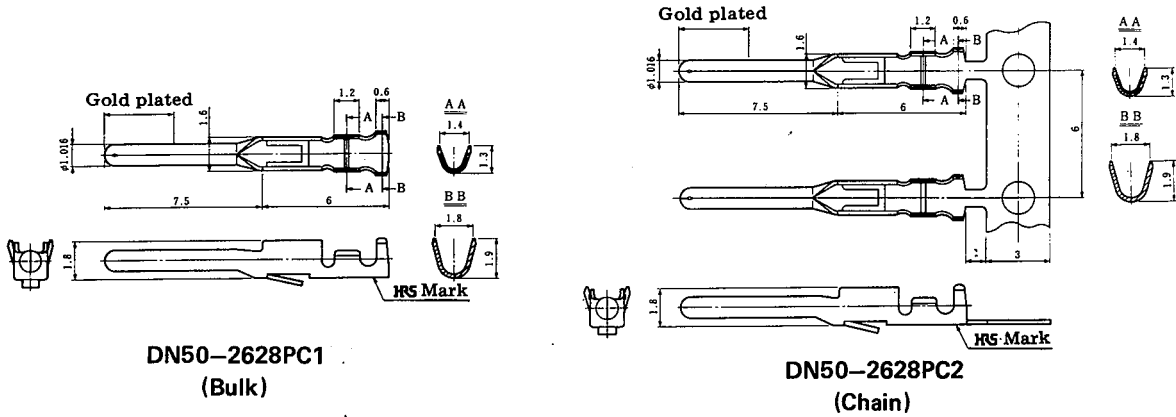

Note: Bulk in bags of 100pcs. Chain on reels of 1,000pcs.

HRS No.	Part No.	Remarks
225-0007-2	DN50-2628PC1	Loose piece contact
225-0008-5	DN50-2628PC2	Strip contact

Applicable Wire

Applicable Wire: AWG No.26~AWG No.28

Unit: mm

Outer diameter of applicable wire

Way	20	26	36	50
Outer diameter	Max. 9.0	Max. 9.7	Max. 11.0	Max. 12.0

Tooling (for Crimp Plug)

● CM-105 Crimp Machine

This machine has been carefully designed to meet the many requests for advanced crimping machines that can be used in a wider range of applications. This machine offers easy setup adjustment and applicator mounting. We are confident that the machine will find many applications as an easy-to-use semi-automatic machine for crimping strip contacts.

POWER SOURCE	AC 100V 200W
TOTAL WEIGHT	75 kgs
PERFORMANCE	2,000 - 4,000 crimps per hour
WORK RANGE	Adaptable to other HIROSE dies

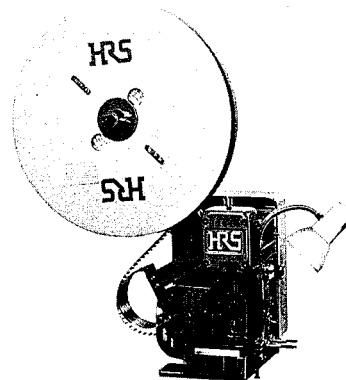

Semi-Auto Machine

CM-105
(CL901-0005-4)
Applicator (Die) 105-DN50
(CL901-0208-1)



Hand Tool

DN50-TA2628HC
(CL250-0101-0)

Tooling (for IDC Plug)

Hand Press

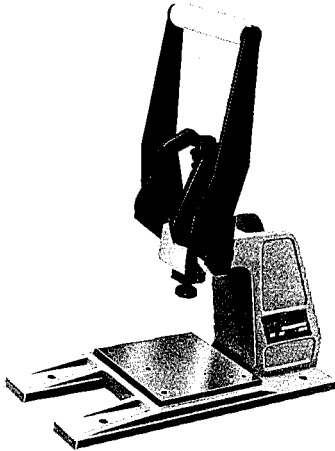

HRS No.	Part No.
550-0082-2	Hi-Flex termination press and accessories

Pressure Block

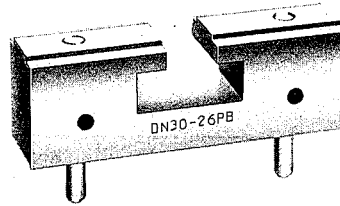

HRS No.	Part No.
902-0068-0	DN30-26PB
902-0069-3	DN30-36PB
902-0143-4	DN30-20PB
902-0144-7	DN30-50PB

Universal Guide Plate

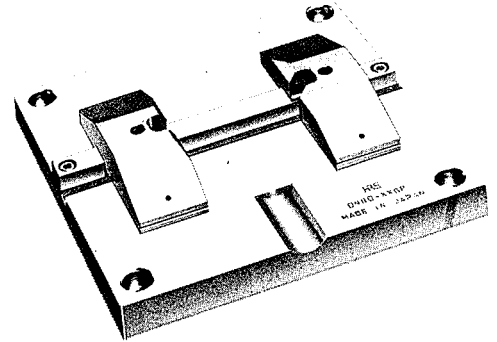

HRS No.	Part No.
902-0067-8	DN30-XXGP

Hi-Flex Termination Press and Accessories

General

The Hi-Flex termination press and its accessories connect the connectors to the HIF series ribbon cables more securely and quickly.

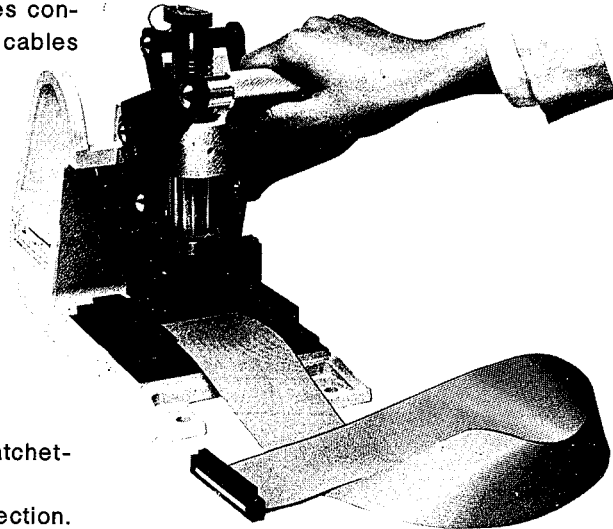

Features

1. No incomplete connections. A preventive ratchet-type device ensures against misconnections.
2. Prevents damage to connectors during connection. The guide plate works as a stopper to prevent damage to connectors due to connection pressure.
3. Easy to position the connector and cable. The guide plate case guide and cable stopper help positioning.
4. Capable of cable connection at an intermediate point when the cable stopper is removed.