

### Multi DomiLED™

Synonymous with function and performance, the Multi DomiLED™ series is perfectly suited for a variety of cross-industrial applications due to its small package outline, durability and superior brightness.

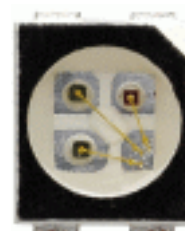

### Features:

- > High brightness tri-color surface mount LED.
- > Capable for all video-standards.
- > The RGB-LED chips can be controlled separately.
- > 120° viewing angle.
- > Small package outline (LxWxH) of 3.2 x 2.8 x 1.8mm.
- > Qualified according to JEDEC moisture sensitivity Level 2.
- > Compatible to both IR reflow soldering and TTW soldering.
- > Environmental friendly; RoHS compliance.



### Applications:

- > Automotive: interior applications, eg: switches, telematics, climate control system, dashboard, etc.
- > Consumer Appliances: LCD illumination as in PDAs, LCD TV.
- > Communication: indicator and backlight in mobilephone.
- > Display: full color display video notice board.
- > Industry: white goods (eg: Oven, microwave, etc.).



Part Ordering Number	Color, $\lambda_{dom}$ (nm)			Viewing Angle°	Luminous Intensity @ IF = 20mA IV (mcd)		
	Chip #1	Chip #2	Chip #3		Chip #1	Chip #2	Chip #3
<b>DMRTB-CJB-RS+ST+PQ-1</b>	Red	True Green	Blue	<b>120</b>	<b>100.0 - 200.0</b>	<b>140.0 - 285.0</b>	<b>35.5 - 100.0</b>
• DMRTB-CJB-R3S3N3	625nm	525nm	470nm		100.0 - 140.0	140.0 - 200.0	35.5 - 50.5
• DMRTB-CJB-R3S3P3					100.0 - 140.0	140.0 - 200.0	50.5 - 71.5
• DMRTB-CJB-R3S3Q3					100.0 - 140.0	140.0 - 200.0	71.5 - 100.0
• DMRTB-CJB-R3T3N3					100.0 - 140.0	200.0 - 285.0	35.5 - 50.5
• DMRTB-CJB-R3T3P3					100.0 - 140.0	200.0 - 285.0	50.5 - 71.5
• DMRTB-CJB-R3T3Q3					100.0 - 140.0	200.0 - 285.0	71.5 - 100.0
• DMRTB-CJB-S3S3N3					140.0 - 200.0	140.0 - 200.0	35.5 - 50.5
• DMRTB-CJB-S3S3P3					140.0 - 200.0	140.0 - 200.0	50.5 - 71.5
• DMRTB-CJB-S3S3Q3					140.0 - 200.0	140.0 - 200.0	71.5 - 100.0
• DMRTB-CJB-S3T3N3					140.0 - 200.0	200.0 - 285.0	35.5 - 50.5
• DMRTB-CJB-S3T3P3					140.0 - 200.0	200.0 - 285.0	50.5 - 71.5
• DMRTB-CJB-S3T3Q3					140.0 - 200.0	200.0 - 285.0	71.5 - 100.0

**NOTE**

1. Reel comes in a quantity of 1025 and 2050 units per reel.
2. Luminous intensity is measured with an accuracy of  $\pm 11\%$ .
3. All electrical and optical data are measured at room temperature; Ta = 25°C.

### Half Group For Luminous Intensity

Only one IV group is allowed for each chip within reel.

Groupings	Min. (mcd)	Max. (mcd)
N3	35.5	50.5
P3	50.5	71.5
Q3	71.5	100.0
R3	100.0	140.0
S3	140.0	200.0
T3	200.0	285.0

## Wavelength Grouping

If wavelength binning is required, only one wavelength group is allowed for each chip within a reel.

Color	Group	Wavelength distribution (nm)
Red	Full	620 - 630
True Green	Full	521 - 536
	A	521 - 526
	B	526 - 531
	C	531 - 536
Blue	Full	465 - 475
	A	465 - 470
	B	470 - 475

Dominant wavelength is measured with an accuracy of  $\pm 1$  nm.

## Electrical Characteristics at Ta=25°C

	Vf @ If = 20mA		Temperature Coefficient of Vf (If=20mA; -10°C<T<100°C)
	Typ. (V)	Max. (V)	
Red	1.80	2.45	-2.00
True Green	3.70	4.25	-3.60
Blue	3.60	4.25	-3.10

Forward voltage, Vf is measured with an accuracy of  $\pm 0.1$  V.

## Optical Characteristics at Ta=25°C

	Temperature Coefficient (If=20mA; -10°C<T<100°C)	
	$\lambda_{peak}$ (nm/K)	$\lambda_{dom}$ (nm/K)
Red	0.15	0.05
True Green	0.04	0.03
Blue	0.04	0.02

**Absolute Maximum Ratings**

	Maximum Value	Unit
DC forward current	Red=30; True Green, Blue=20	mA
Peak pulse current; (tp ≤ 10µs, Duty cycle = 0.005)	Red=1000; True Green, Blue=200	mA
Reverse voltage	Red=12; True Green, Blue=5	V
Power consumption	Red=75; True Green, Blue=85	V
Thermal resistance junction/ambient, Rth JA 1 chip on 3 chips on	Red=480; True Green, Blue=530 Red=770; True Green, Blue=820	K/W
Thermal resistance junction/ambient, Rth JA 1 chip on 3 chips on	Red=260; True Green, Blue=290 Red=420; True Green, Blue=470	K/W
LED junction temperature	125	°C
Operating temperature	-40 ... +100	°C
Storage temperature	-40 ... +100	°C

**Luminous Intensity Vs Forward Current**

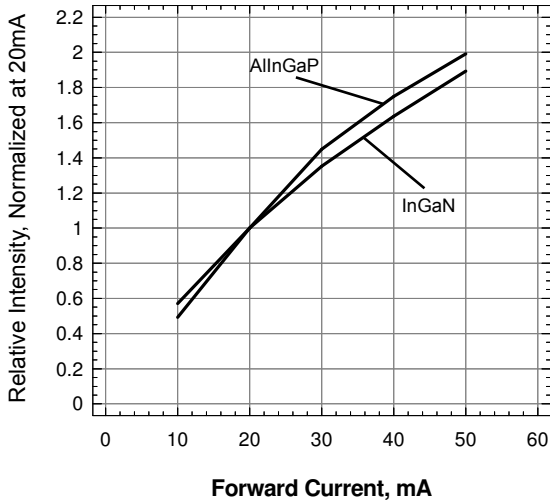

**Wavelength Shift Vs Forward Current**

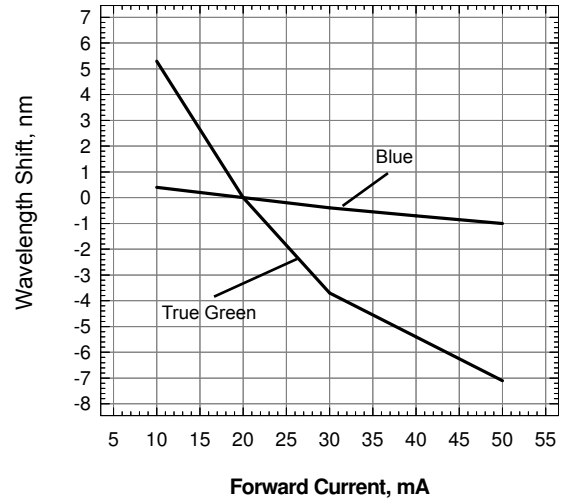

**Relative Intensity Vs Wavelength**

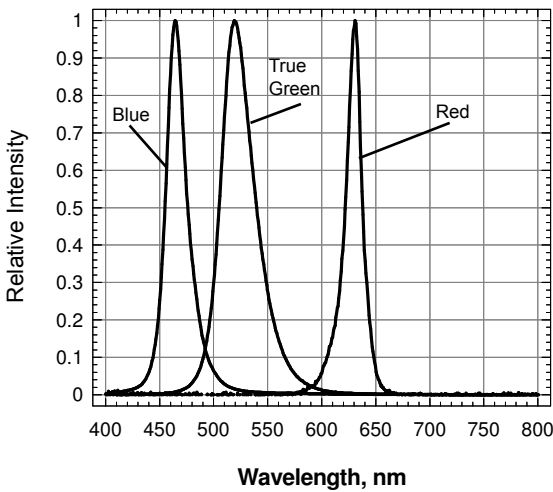

**Forward Current Vs Forward Voltage**

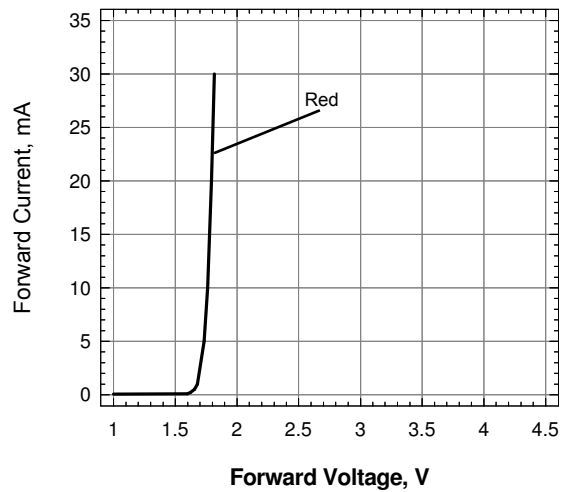

**Forward Current Vs Forward Voltage**

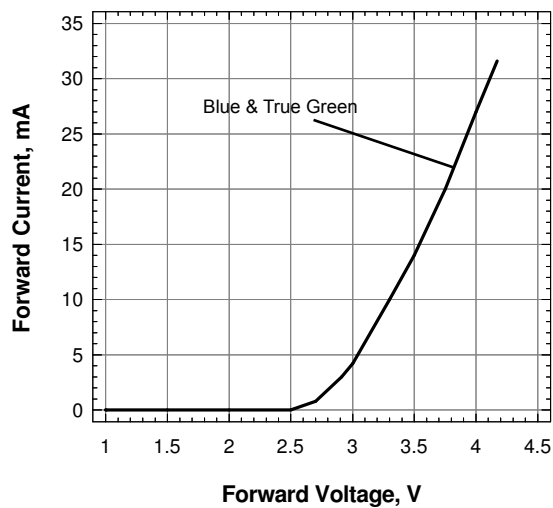

**Radiation Pattern**

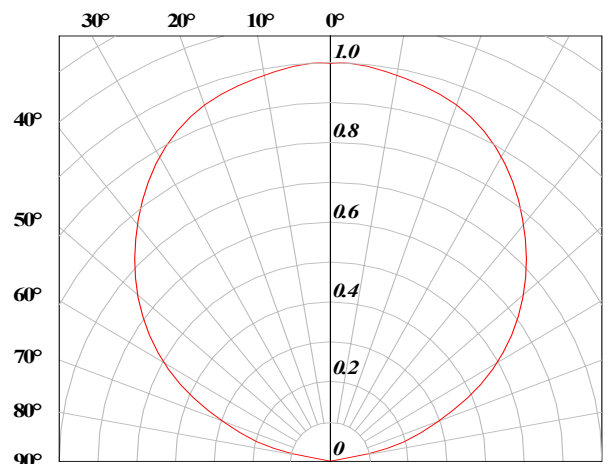

**Maximum Forward Current Vs Temperature (1 chip on)**

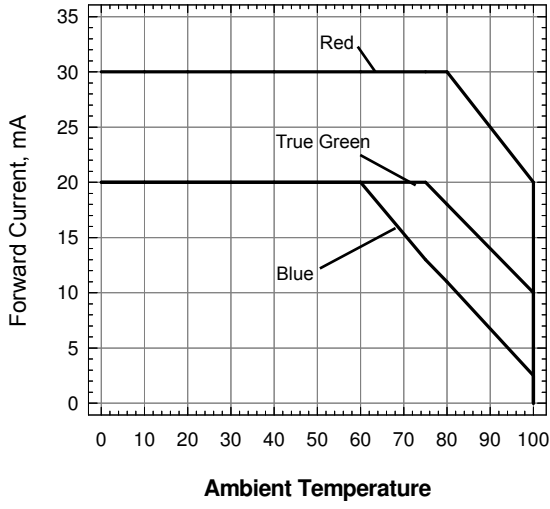

**Maximum Forward Current Vs Temperature (3 chips on)**

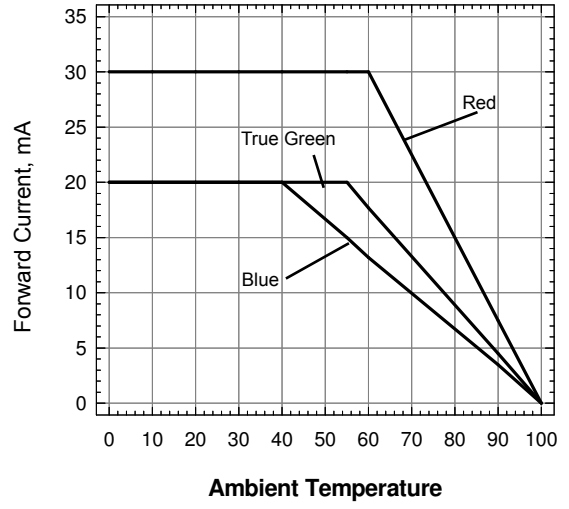

**Maximum Forward Current Vs Temperature (1 chip on)**

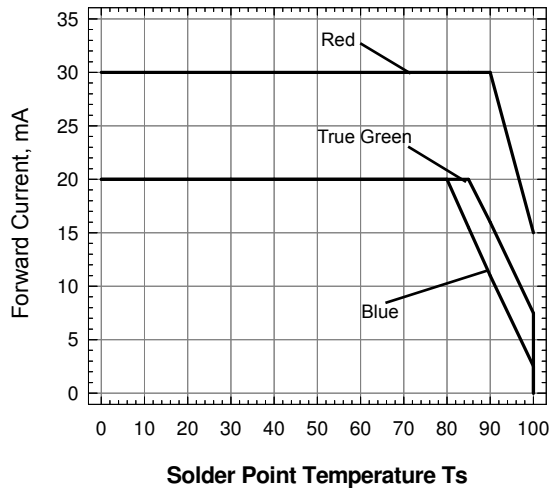

**Maximum Forward Current Vs Temperature (3 chips on)**

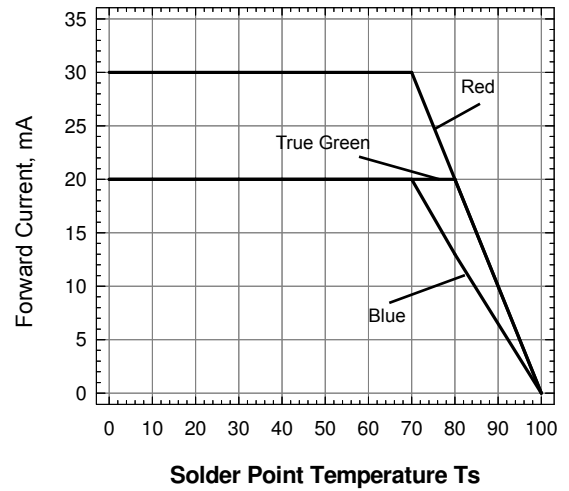

**Multi DomiLED™ • DMRTB-CJ : Tri-Color Package Outlines**

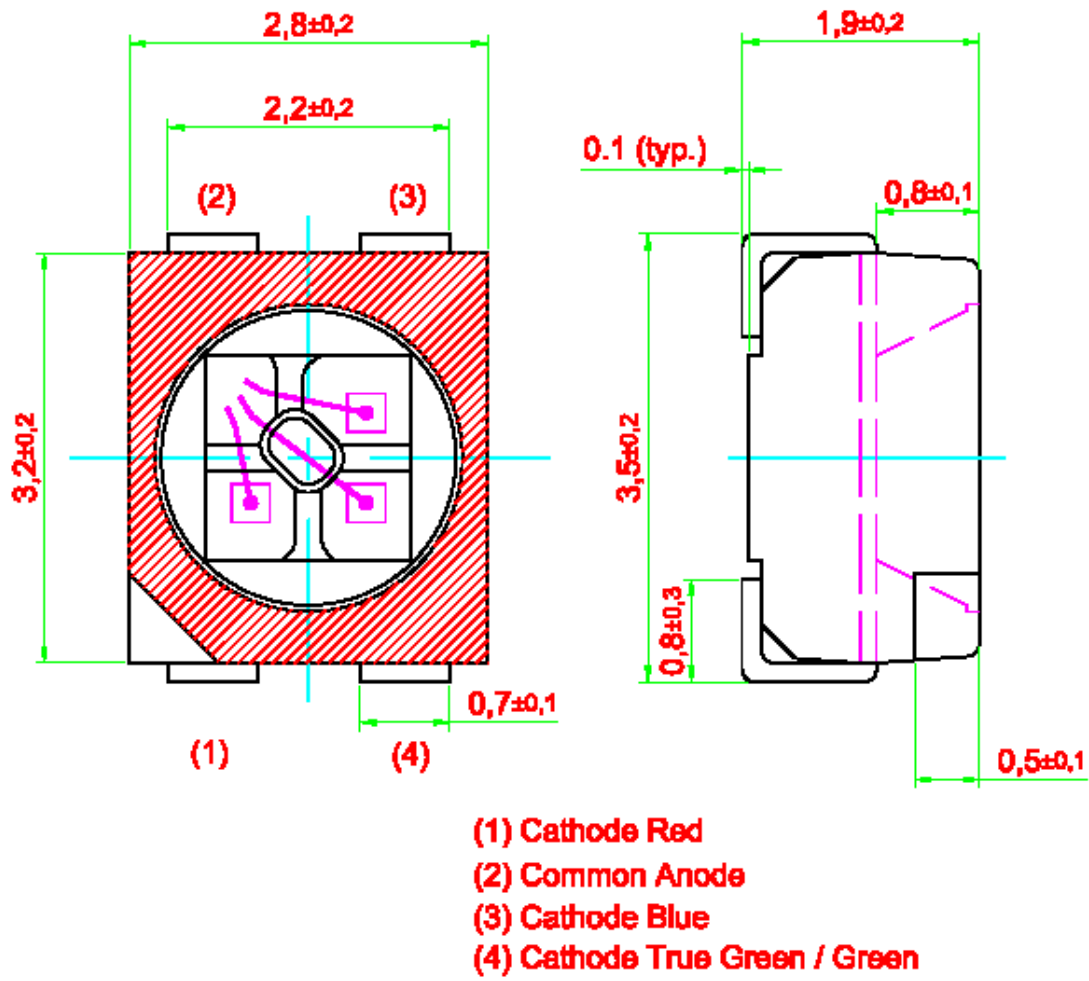

### Recommended Solder Pad

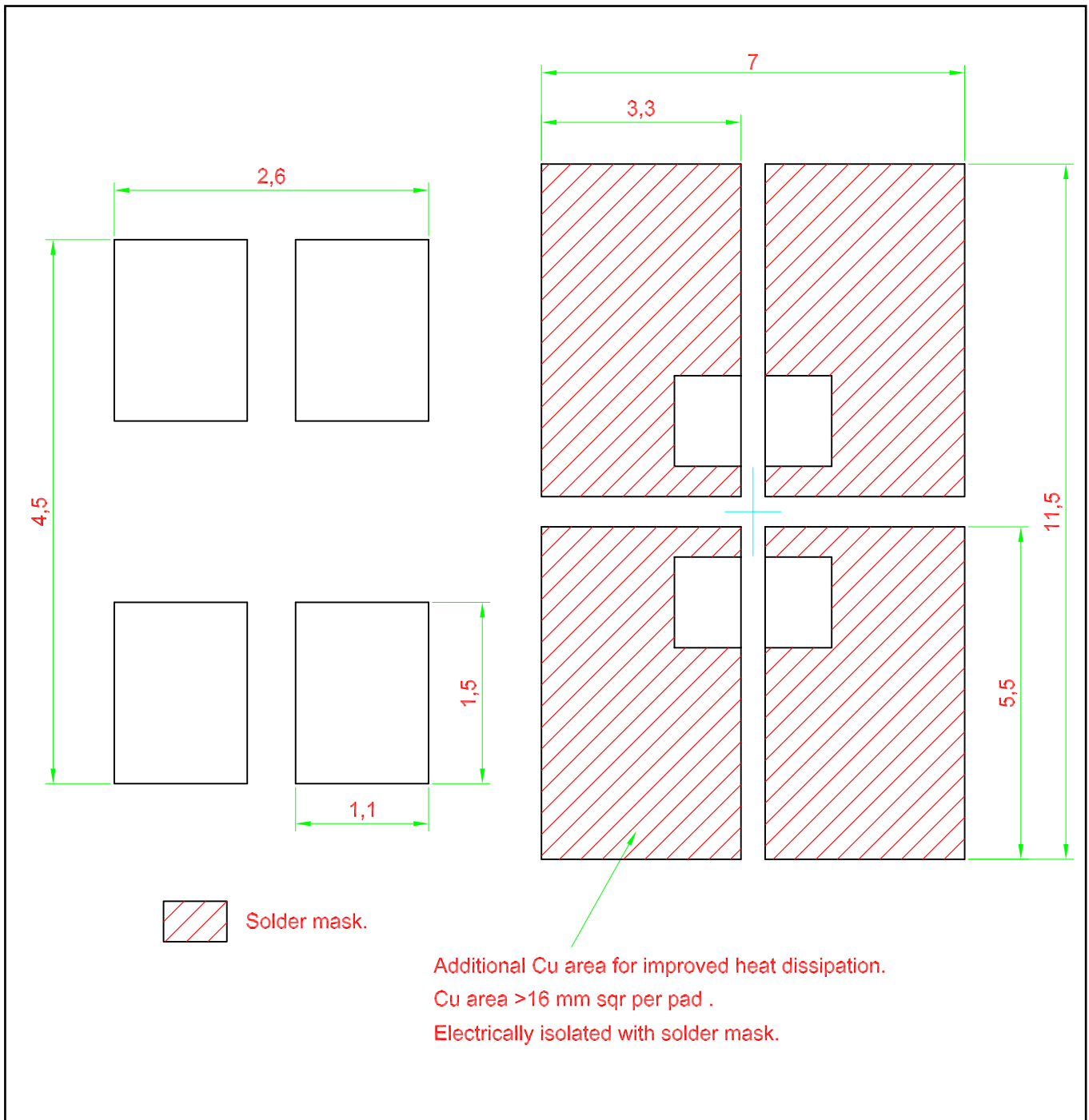



**Taping and orientation**

- Reels come in quantity of 1025 or 2050 units.
- Reel diameter is 180 mm.

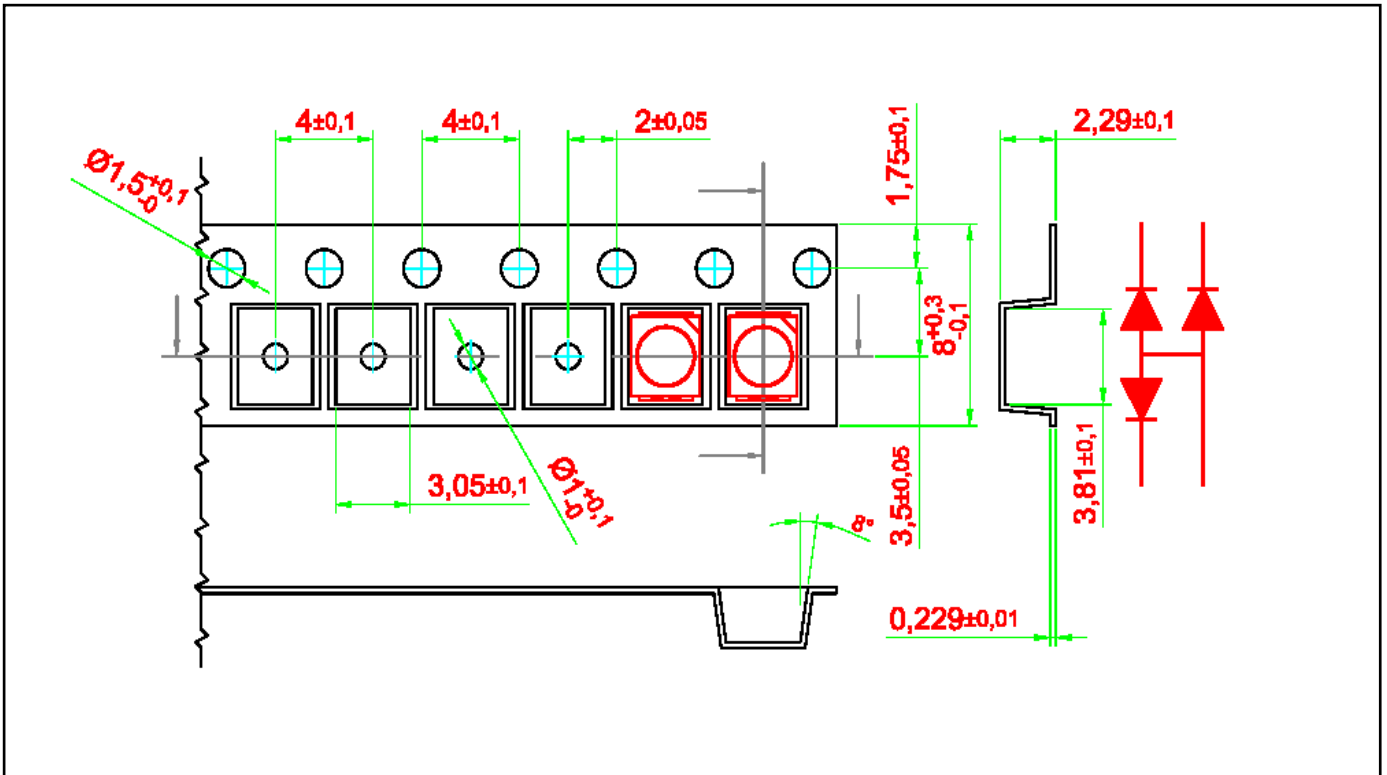

200 mm min. for  $\varnothing 180$  reel.  
200 mm min. for  $\varnothing 330$  reel.

480 mm min. for  $\varnothing 180$  reel.  
960 mm min. for  $\varnothing 330$  reel.

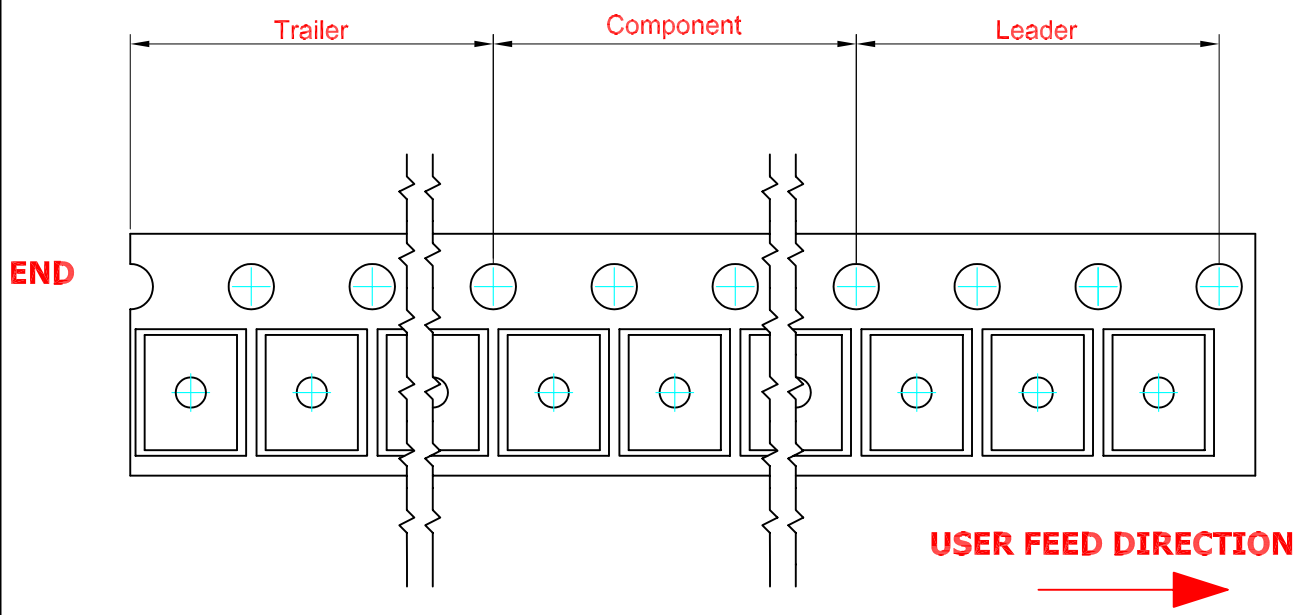

**Packaging Specification**

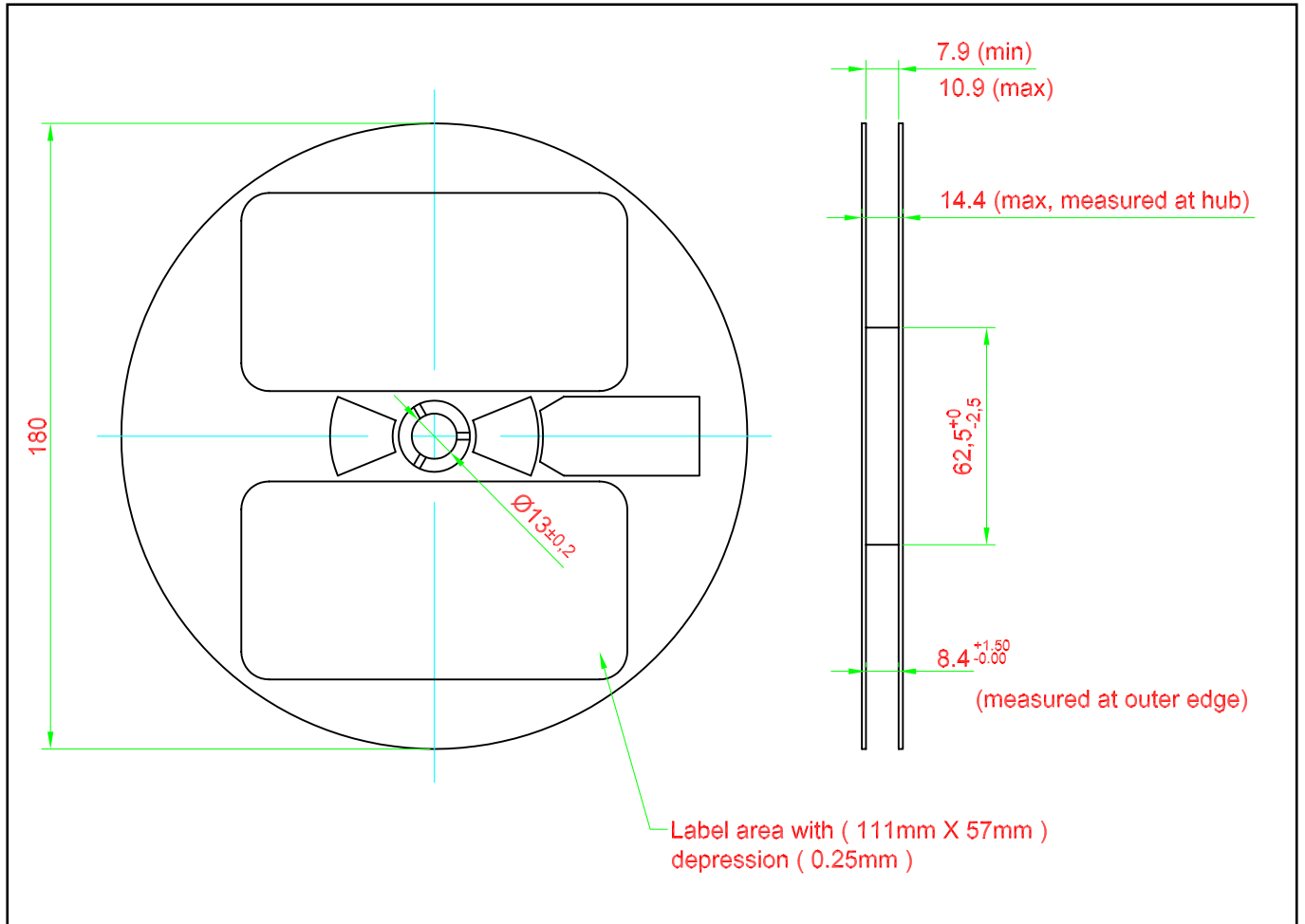

**Packaging Specification**

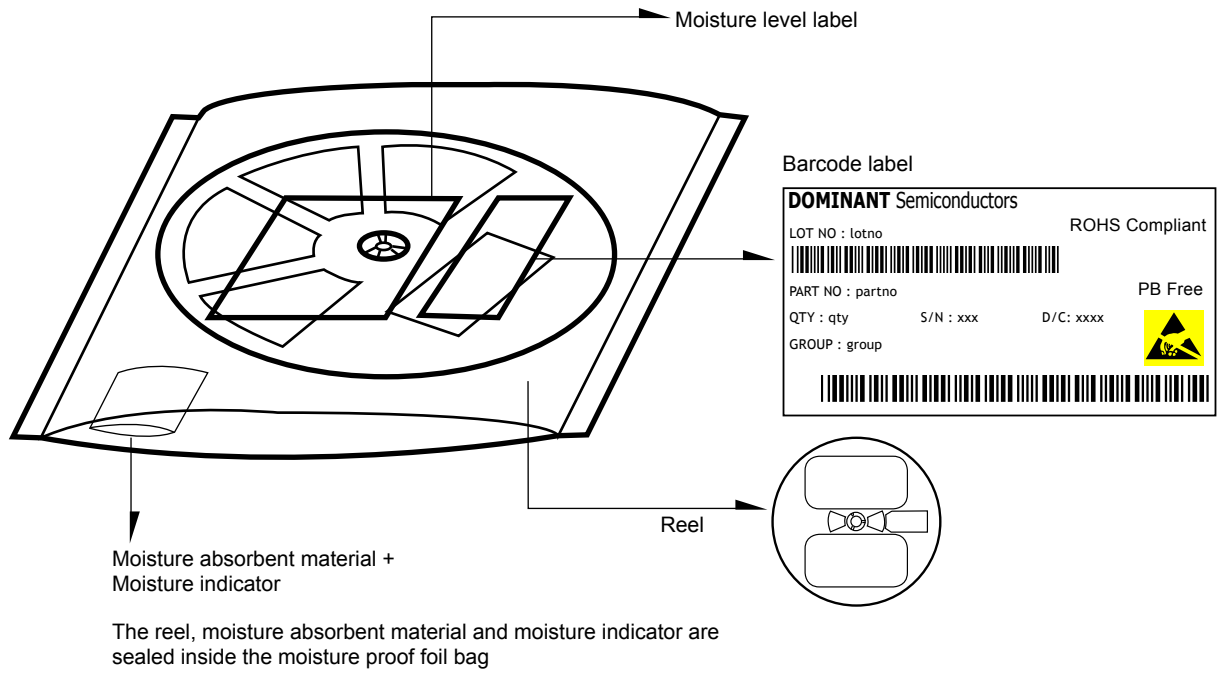

	Average 1pc DomiLED/Multi DomiLED	1 completed bag (2000pcs)
Weight (gram)	0.034	190 ± 10

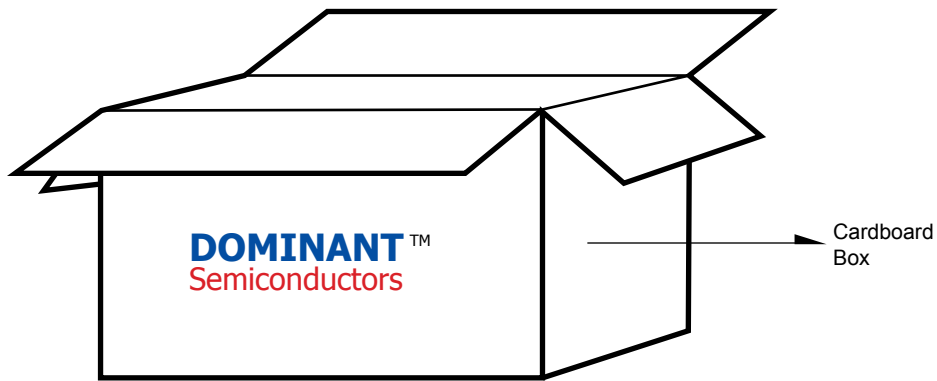

**For Multi DomiLED™**

Cardboard Box Size	Dimensions (mm)	Empty Box Weight (kg)	Reel / Box	Quantity / Box (pcs)
Small	300 x 250 x 250	0.3	15 reels MAX	30,000 MAX
Large	416 x 516 x 476	1.4	50 reels MAX	100,000 MAX

**Recommended Sn-Pb IR-Reflow Soldering Profile**

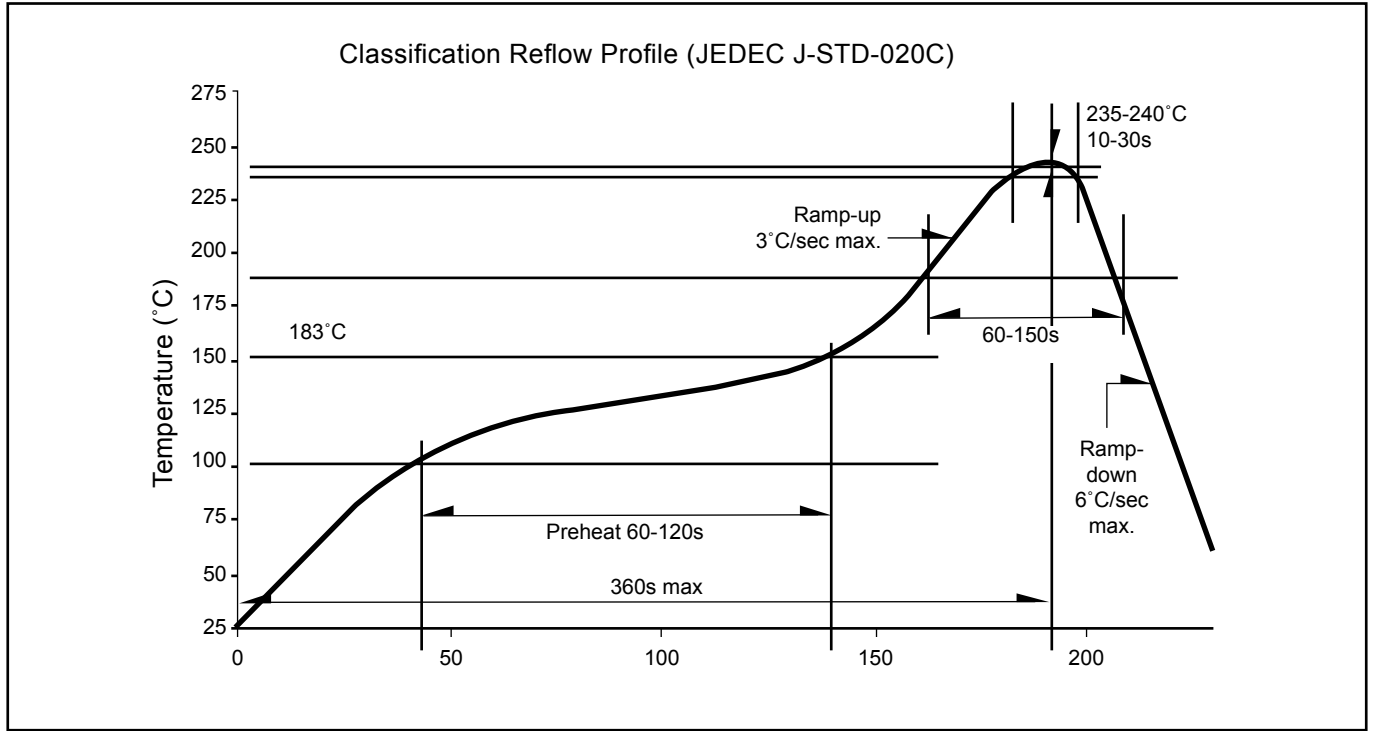

**Recommended Pb-free Soldering Profile**

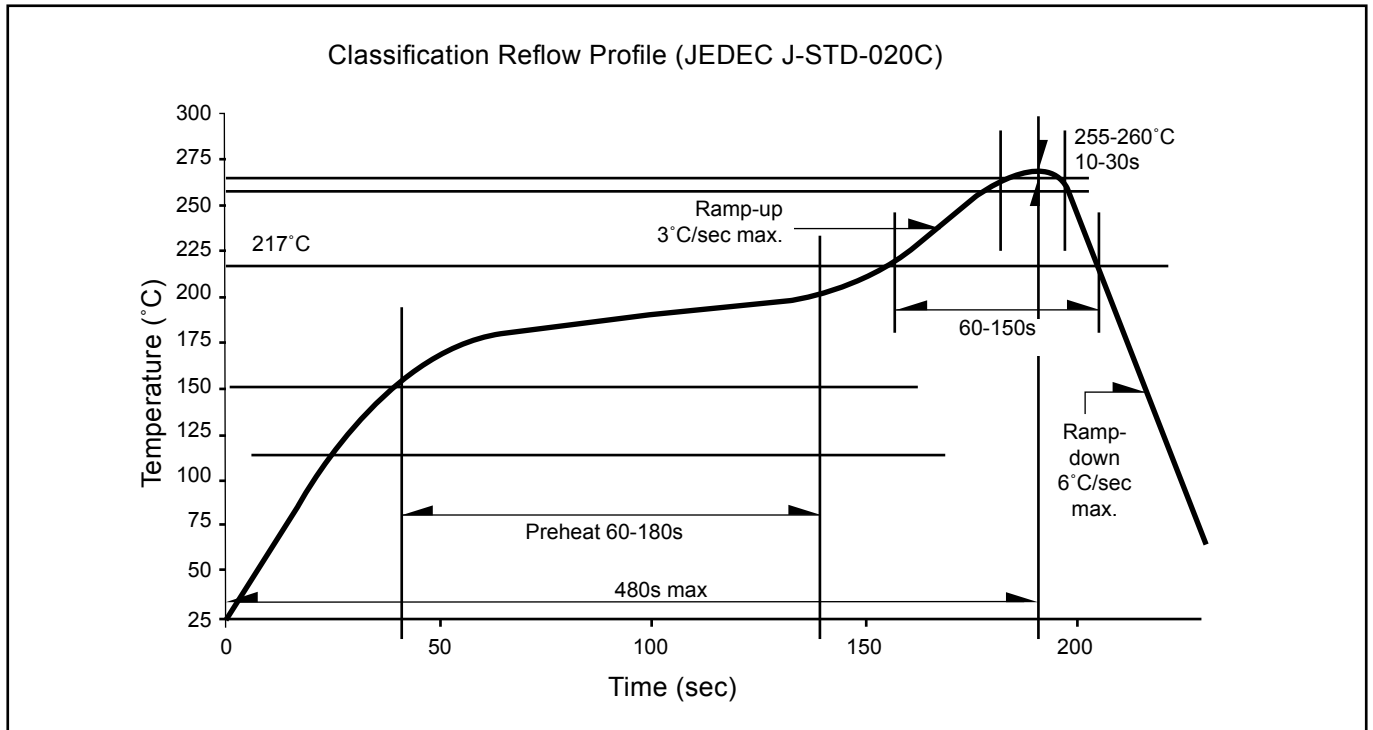

**Revision History**

Page	Subjects	Date of Modification
-	New Format	27 Nov 2006

**NOTE**

All the information contained in this document is considered to be reliable at the time of publishing. However, DOMINANT Semiconductors does not assume any liability arising out of the application or use of any product described herein.

DOMINANT Semiconductors reserves the right to make changes at any time without prior notice to any products in order to improve reliability, function or design.

DOMINANT Semiconductors products are not authorized for use as critical components in life support devices or systems without the express written approval from the Managing Director of DOMINANT Semiconductors.

## About Us

DOMINANT Semiconductors is a dynamic Malaysian Corporation that is among the world's leading SMT LED Manufacturers. An excellence – driven organization, it offers a comprehensive product range for diverse industries and applications. Featuring an internationally certified quality assurance acclaim, DOMINANT's extra bright LEDs are perfectly suited for various lighting applications in the automotive, consumer and communications as well as industrial sectors. With extensive industry experience and relentless pursuit of innovation, DOMINANT's state-of-art manufacturing, research and testing capabilities have become a trusted and reliable brand across the globe. More information about DOMINANT Semiconductors can be found on the Internet at <http://www.dominant-semi.com>.

Please contact us for more information:

### Head Quarter

DOMINANT Semiconductors Sdn. Bhd.  
Lot 6, Batu Berendam, FTZ Phase III, 75350 Melaka, Malaysia  
Tel: (606) 283 3566 Fax: (606) 283 0566  
E-mail: [sales@dominant-semi.com](mailto:sales@dominant-semi.com)

### DOMINANT China Sales Office

DOMINANT Semiconductors (Shenzhen) Co. Ltd.  
24BC Newbaohui Building, No. 1007 West Nanhai Blvd., Nanshan, Shenzhen, China P.C. 518054  
Tel: +86 (755) 86031785 / +86 (755) 86031786 Fax: +86 (755) 86031789  
E-mail: [sales\\_china@dominant-semi.com](mailto:sales_china@dominant-semi.com)

### DOMINANT Korea Sales Office

DOMINANT Semiconductors Korea Inc.  
902 Sunil Technopia, 440 Sangdaewon-dong, Jungwon-gu, Sungnam-si, Kyunggi-do, Korea 462726  
Tel: 82-31-777-3978 Fax: 82-31-777-3976  
E-mail: [sales\\_korea@dominant-semi.com](mailto:sales_korea@dominant-semi.com)

