



Design Example Report

Title	<i>21.7 W Power Supply using TOP246P</i>
Specification	Input: 85 - 265 VAC Output: 48 V / 450 mA
Application	PoE AC Adapter
Author	Power Integrations Applications Department
Document Number	DER-97
Date	September 12, 2005
Revision	1.0

Summary and Features

- Single Sided PC board
- Reduced cost and component count
- Eliminates two y-capacitors to ground
- Eliminates secondary side common mode choke
- Eliminates ground wire differential choke
- High Efficiency (~ 80 %)
- Lower Cost Transformer Construction – no sleeving termination required
- Low EMI signature (both radiated and conducted emissions)
- Built-in output short circuit protection

The products and applications illustrated herein (including circuits external to the products and transformer construction) may be covered by one or more U.S. and foreign patents or potentially by pending U.S. and foreign patent applications assigned to Power Integrations. A complete list of Power Integrations' patents may be found at www.powerint.com.

Table Of Contents

1	Introduction.....	3
2	Power Supply Specification	4
3	Schematic.....	5
4	Circuit Operation	6
4.1	General	6
4.2	Description	6
5	Bill of Materials	7
6	Layout.....	9
7	Transformer Design Spreadsheet	10
8	Transformer Specification.....	13
9	Performance.....	17
9.1	Efficiency.....	17
9.2	Regulation vs. Load.....	18
9.3	Regulation vs. Line.....	19
9.4	Raw Performance Data	20
10	Waveforms.....	21
10.1	Drain Current and Voltage.....	21
10.2	Output Transient Load Response	22
10.3	Output Ripple Voltage	23
10.4	Switching Ripple.....	23
10.5	Line Frequency Ripple	24
10.6	Output Voltage Shutdown Profile	26
11	Thermal Test.....	27
11.1	Thermal Performance.....	27
12	Conducted EMI	29
12.1	Conducted EMI Performance	29
13	Revision History	30

Important Notes:

Although this board is designed to satisfy safety isolation requirements, the engineering prototype has not been agency approved. Therefore, all testing should be performed using an isolated source to provide power to the prototype board.

Design Reports contain a power supply design specification, schematic, bill of materials, and transformer documentation. Performance data and typical operation characteristics are included. Typically only a single prototype has been built.



1 Introduction

This document is an engineering report describing a Power over Ethernet (PoE) power supply utilizing TOP246P. The power supply delivers 21.7 W continuous from an input of 85 to 265 VAC.

This document provides complete design information including specification, schematic, bill of material and transformer design and construction information. The document also provides performance information.

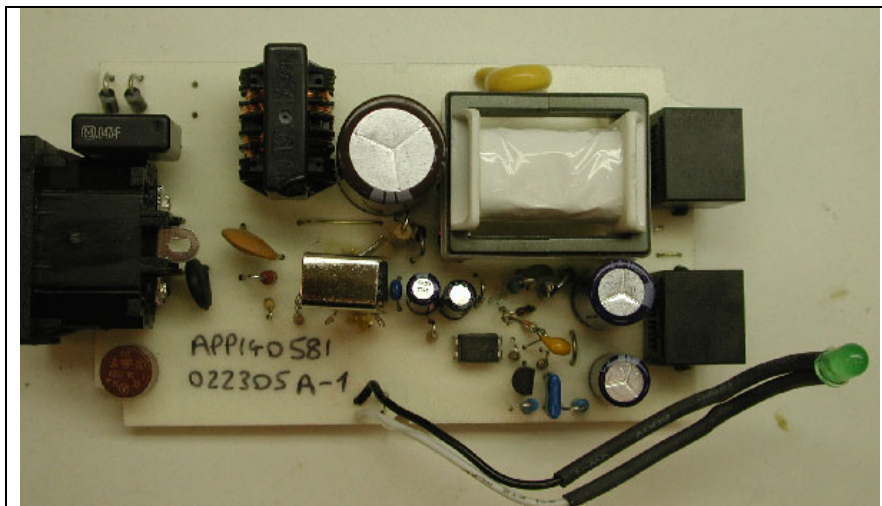

Figure 1 – Circuit Board - Top View

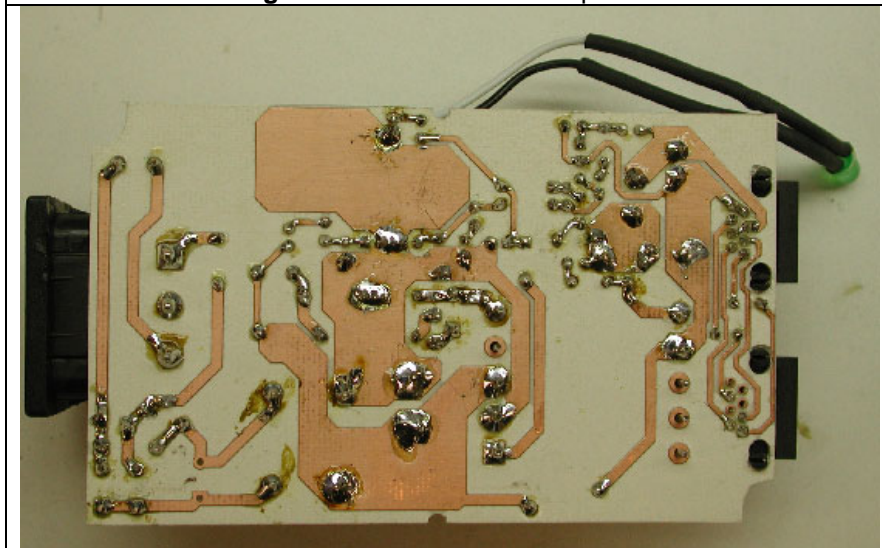

Figure 2 – Circuit Board - Bottom View

2 Power Supply Specification

Description	Symbol	Min	Typ	Max	Units	Comment
Input Voltage	V_{IN}	85		265	VAC	
Output Output Voltage 1	V_{OUT1}	47.52	48	48.48	V	± 1% 20 MHz bandwidth
Output Ripple Voltage 1	$V_{RIPPLE1}$			480	mVp-p	
Output Current 1	I_{OUT1}	0		450	mA	
Power Down Holdup 115 VAC	$T_{H(115VAC)}$	18			ms	
230 VAC	$T_{H(230VAC)}$	60			ms	
Total Output Power Average Output Power	P_{OUT1}		21.7		W	
Full Load Efficiency	η		80		%	
Environmental Conducted EMI Safety						Meets CISPR22B / EN55022B Designed to meet IEC950, UL1950 Class II
Ambient Temperature	T_{AMB}	0		40	°C	Forced airflow



3 Schematic

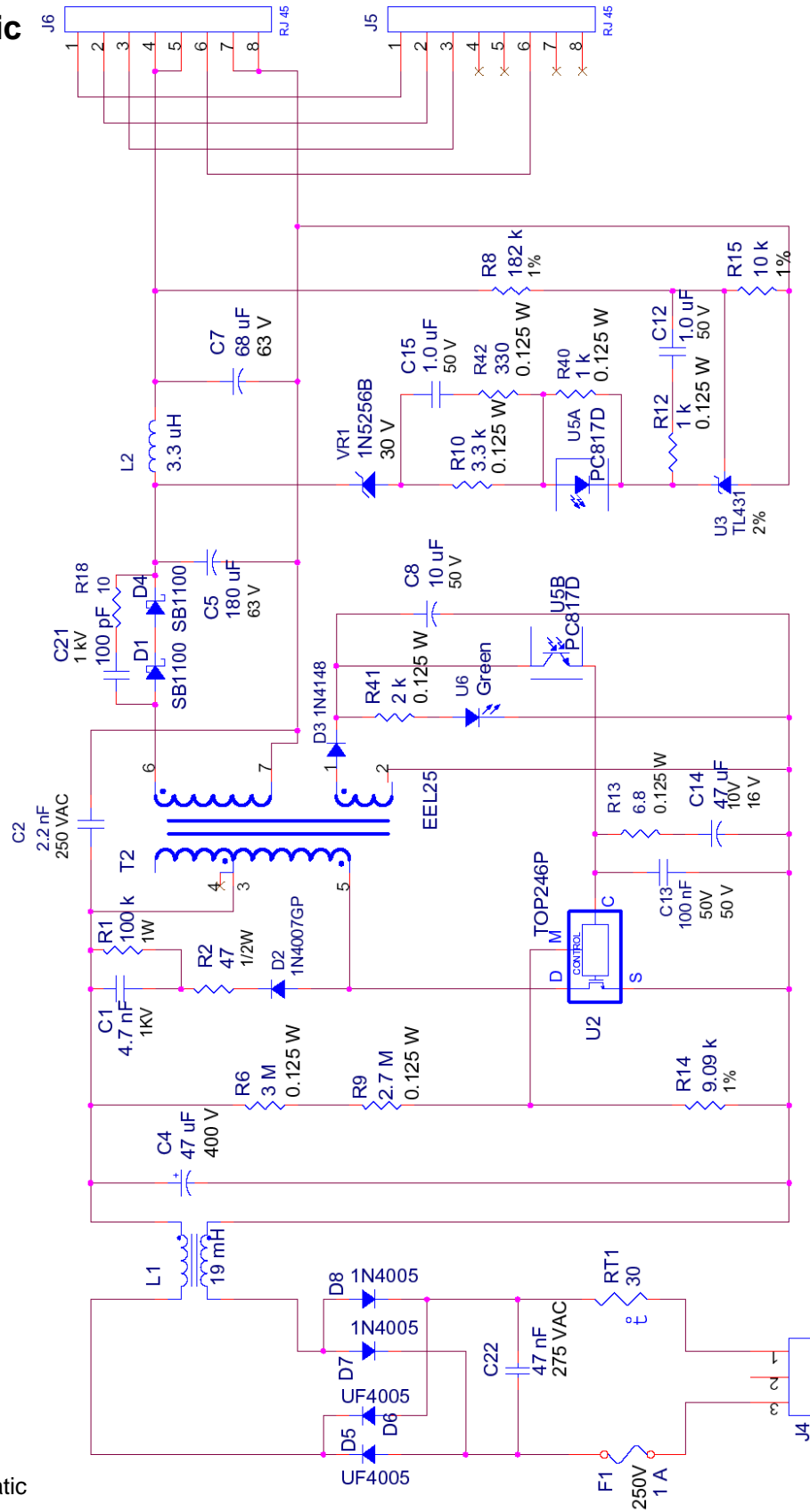

Figure 3 – Schematic



4 Circuit Operation

4.1 General

The power supply uses a TOP246P device (U2), with integrated MOSFET and controller, in an isolated flyback configuration. The circuit also uses the x-pin programmable current limit feature control the overload power of the power supply and also to minimize transformer size.

4.2 Description

The input fuse F1 protects the supply against catastrophic failure. Thermistor RT1 limits the in-rush current during power-up. Diodes D5 – D8 implement a bridge rectifier to rectify the input mains voltage. Capacitor C22 attenuates the EMI generated by the input bridge diodes D5-D8.

Inductor L1 is used to attenuate both differential and common mode EMI noise from the power supply. A large value is used to also prevent any noise filtering through from networks connector to the power supply output. Capacitor C2 forms part of the EMI solution by shunting EMI signals generated across the transformer T2. Capacitor C4 decouples the rectified input voltage providing a DC-bus. Resistor R14 programs the current limit of the TOPSwitch-GX (U2). Resistors R6 and R9 modified this current limit with input voltage, to maintain a relatively flat output overload profile. Diode D2, R2, C1 and R1 implement an RCD clamp circuit to limit the leakage inductance spike on the TOPSwitch-GX Drain pin. Diode D3 and C8 implement a bias voltage supply to provide operating power to the TOPSwitch-GX with integrated PWM, controller and main switching MOSFET. Capacitors C13 and C14 provide device decoupling with C14 also programming the startup and auto-restart period of the device. Resistor R13 provides feedback compensation in conjunction with C14. The inductance of transformer T2 provides the energy storage and conversion component of the circuit. Resistor R41 feeds current to an indicator LED U6, which is illuminated during normal operation.

The 48 V output is rectified and filtered by diodes D1 and D4 and capacitors C5 with C7 provided output decoupling. Resistor R18 and C21 snub high frequency ringing on these diodes. Resistors R8 and R15 sense the output voltage providing the input signal for the TL431 (U3) reference. Resistor R41 provides DC bias current (approx. 1 mA) to the U3. Components R12 and C12 provide compensation for U3, to make sure that it's frequency response is limited only to low-frequency signals. Resistor R10 programs the high-frequency gain of the control loop and with opto-diode U5A transmits the feedback signal. Resistor R42 and C15 provide increase the high frequency gain of the feedback circuit to improve output ripple rejection. Zener diode VR1 is used due to the high 48 V output voltage and drops approximately 30 V, to bring the TL431 collector voltage comfortably within safe levels (i.e. less than 30 V). Opto-transistor U5B feeds the control signal back to the TOPSwitch-GX.



5 Bill of Materials

Item	Qty.	Ref.	Description	Mfg Part Number	Mfg
1	1	C1	4.7 nF, 1 kV, Thru Hole, Disc Ceramic	5GAD47	Vishay/Sprague
2	1	C2	2.2 nF, Ceramic, Y1	440LD22	Vishay
3	1	C4	47 uF, 400 V, Electrolytic, Low ESR, 730 mOhm, (16 x 25)	KMX400VB47RM16X25LL	United Chemi-Con
4	1	C5	180 uF, 63, Electrolytic, Low ESR, 145 mOhm, (10 x 20)	LXZ63VB181MJ20LL	United Chemi-Con
5	1	C7	68 uF, 63, Electrolytic, Low ESR, 340 mOhm, (8 x 12)	LXZ63VB68RMH15LL	United Chemi-Con
6	1	C8	10 uF, 50 V, Electrolytic, Gen. Purpose, (5 x 11)	KME50VB10RM5X11LL	United Chemi-Con
7	2	C12 C15	1.0 uF, 50 V, Ceramic, Z5U	ECU-S1H105MEB	Panasonic
8	1	C13	100 nF, 50 V, Ceramic, X7R	ECU-S1H104KBB	Panasonic
9	1	C14	47 uF, 16 V, Electrolytic, Low ESR, 500 mOhm, (5 x 11.5)	LXZ16VB47RME11LL	United Chemi-Con
10	1	C21	100 pF, 1 kV, Disc Ceramic	NCD101K1KVY5F	NIC Components Corp
11	1	C22	47 nF, 275 VAC, Film, X2	ECQU2A473ML	Panasonic
12	2	D1 D4	100 V, 1 A, Schottky, DO-41	SB1100	Fairchild
13	1	D2	1000 V, 1 A, Rectifier, Glass Passivated, 2 us, DO-41	1N4007GP	Vishay
14	1	D3	75 V, 300 mA, Fast Switching, DO-35	1N4148	Vishay
15	2	D5 D6	600 V, 1 A, Ultrafast Recovery, 75 ns, DO-41	UF4005	Vishay
16	2	D7 D8	600 V, 1 A, Rectifier, DO-41	1N4005	Vishay
17	1	F1	1 A, 250V, Slow, TR5	3,721,100,041	Wickman
18	1	J4	AC Input Receptacle and Accessory Plug, PCBM	161-R301SN13	Kobiconn
19	2	J5 J6	R/A, RJ45 Nonshielded, PCBM	RJHS-5080	Amphenol Canada
20	1	L1	19 mH, 0.5 A, Common Mode Choke	ELF15N005A	Panasonic
21	1	L2	3.3 uH, 2.66 A	822LY-3R3M	Toko
22	1	R1	100 k, 5%, 1 W, Metal Oxide	RSF100JB-100K	Yageo
23	1	R2	47 R, 5%, 1/2 W, Carbon Film	CFR-50JB-47R	Yageo
24	1	R6	3 M, 5%, 1/8 W, Carbon Film	CFR-12JB-3M0	Yageo
25	1	R8	182 k, 1%, 1/4 W, Metal Film	MFR-25FBF-182K	Yageo
26	1	R9	2.7 M, 5%, 1/8 W, Carbon Film	CFR-12JB-2M7	Yageo
27	1	R10	3.3 k, 5%, 1/8 W, Carbon Film	CFR-12JB-3K3	Yageo
28	2	R12 R40	1 k, 5%, 1/8 W, Carbon Film	CFR-12JB-1K0	Yageo
29	1	R13	6.8 R, 5%, 1/8 W, Carbon Film	CFR-12JB-6R8	Yageo



30	1	R14	9.09 k, 1%, 1/4 W, Metal Film	MFR-25FBB-9K09	Yageo
31	1	R15	10 k, 1%, 1/4 W, Metal Film	MFR-25FBB-10K0	Yageo
32	1	R18	10 R, 5%, 1/4 W, Carbon Film	CFR-25JB-10R	Yageo
33	1	R41	2 k, 5%, 1/8 W, Carbon Film	CFR-12JB-2K0	Yageo
34	1	R42	330 R, 5%, 1/8 W, Carbon Film	CFR-12JB-330R	Yageo
35	1	RT1	NTC Thermistor, 30 Ohms, 1.5 A	CL210	Thermometrics
36	1	T2	Bobbin, EEL25.4, Horizontal, 10 pins	YW-236-03B	Yih-Hwa Enterprises
37	1	U2	TOPSwitch-GX, TOP246P, DIP-8B	TOP246P	Power Integrations
38	1	U3	2.495 V Shunt Regulator IC, 2%, 0 to 70C, TO-92	TL431CLP	Texas Instruments
39	1	U5	Opto coupler, 35 V, CTR 300-600%, 4-DIP	ISP817D, PC817X4	Isocom, Sharp
40	1	U6	LED, Green, 5 mm, 565 nm, 30 mcd	SSL-LX5093GD	Lumex Opto
41	1	VR1	30 V, 5%, 500 mW, DO-35	1N5256B	Microsemi
	47	Total			



6 Layout

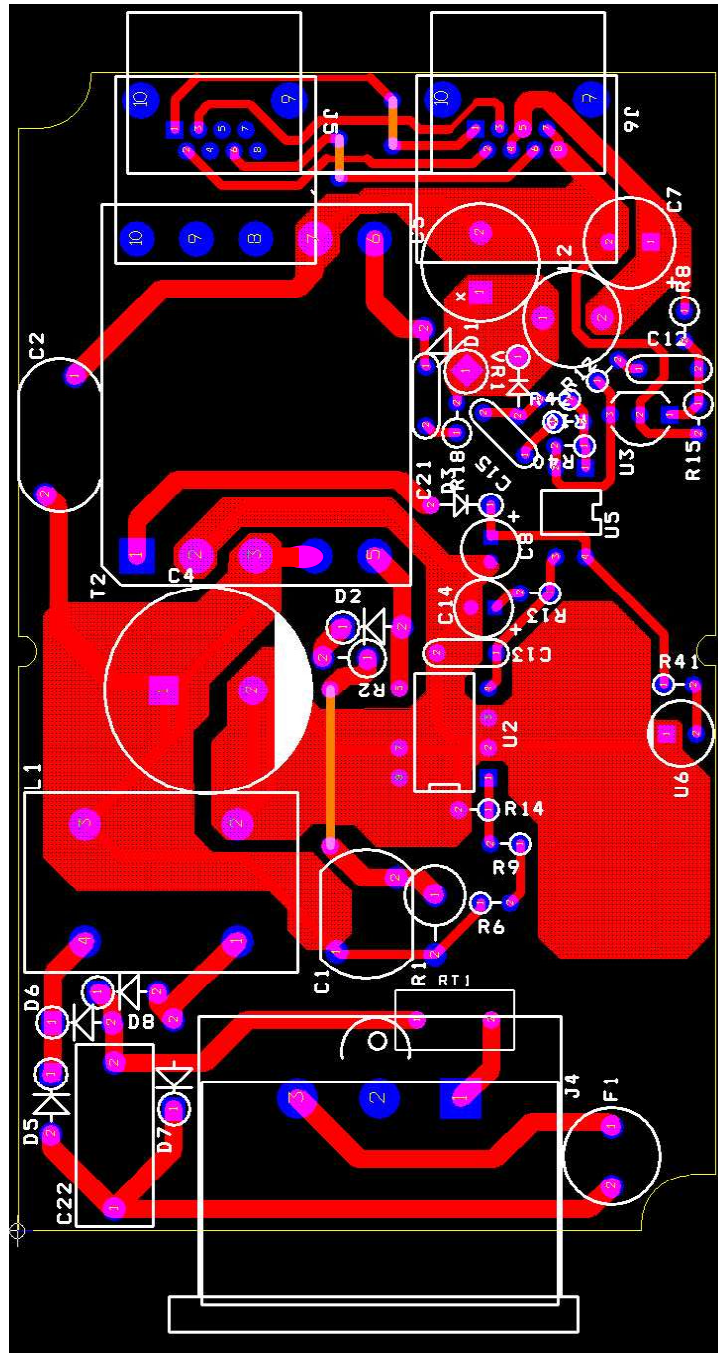

Figure 4 – PC Board Layout



7 Transformer Design Spreadsheet

ACDC_TOPSwitchGX_020 105; Rev.2.5; Copyright Power Integrations 2005	INPUT	INFO	OUTPUT	UNIT	TOP_GX_FX_020105.xls: TOPSwitch-GX/FX Continuous/Discontinuous Flyback Transformer Design Spreadsheet
ENTER APPLICATION VARIABLES					Customer
VACMIN	85			Volts	
VACMAX	265			Volts	Maximum AC Input Voltage
fL	50			Hertz	AC Mains Frequency
VO	48			Volts	Output Voltage (main)
PO	21.7			Watts	Output Power
n	0.86				Efficiency Estimate
Z	0.44				Loss Allocation Factor
VB	12			Volts	Bias Voltage
tC	2.66			mSeconds	Bridge Rectifier Conduction Time Estimate
CIN	47			uFarads	Input Filter Capacitor
ENTER TOPSWITCH-GX VARIABLES					
TOP-GX	top246p			<i>Universal</i>	<i>115 Doubled/230V</i>
Chosen Device		TOP246P	Power Out	26W	34W
KI	0.78				External Ilimit reduction factor (KI=1.0 for default ILIMIT, KI <1.0 for lower ILIMIT)
ILIMITMIN			0.948	Amps	Use 1% resistor in setting external ILIMIT. Assumes 0.85 derating at 100 degrees Celsius
ILIMITMAX			1.158	Amps	Use 1% resistor in setting external ILIMIT
Frequency (F)=132kHz, (H)=66kHz	F				Full (F) frequency option - 132kHz
fS			132000	Hertz	TOPSwitch-GX Switching Frequency: Choose between 132 kHz and 66 kHz
fSmin			124000	Hertz	TOPSwitch-GX Minimum Switching Frequency
fSmax			140000	Hertz	TOPSwitch-GX Maximum Switching Frequency
VOR	90			Volts	Reflected Output Voltage
VDS	2			Volts	TOPSwitch on-state Drain to Source Voltage
VD	1			Volts	Output Winding Diode Forward Voltage Drop
VDB	0.7			Volts	Bias Winding Diode Forward Voltage Drop
KP	0.68				Ripple to Peak Current Ratio (0.4 < KRP < 1.0 : 1.0 < KDP < 6.0)
ENTER TRANSFORMER CORE/CONSTRUCTION VARIABLES					
Core Type	eel25				
Core		EEL25		P/N:	PC40EE25.4/32/6.4-Z
Bobbin		EEL25_B OBBIN		P/N:	*
AE			0.404	cm^2	Core Effective Cross Sectional Area
LE			7.34	cm	Core Effective Path Length
AL			1420	nH/T^2	Ungapped Core Effective Inductance
BW			22.3	mm	Bobbin Physical Winding Width
M	3			mm	Safety Margin Width (Half the Primary to Secondary Creepage Distance)
L	1				Number of Primary Layers
NS	21				Number of Secondary Turns
DC INPUT VOLTAGE PARAMETERS					
VMIN			81	Volts	Minimum DC Input Voltage
VMAX			375	Volts	Maximum DC Input Voltage
CURRENT WAVEFORM SHAPE PARAMETERS					
DMAX			0.53		Maximum Duty Cycle
I AVG			0.31	Amps	Average Primary Current
IP			0.89	Amps	Peak Primary Current
IR			0.60	Amps	Primary Ripple Current
IRMS			0.45	Amps	Primary RMS Current



TRANSFORMER PRIMARY DESIGN PARAMETERS					
LP			532	uHenries	Primary Inductance
NP			39		Primary Winding Number of Turns
NB			5		Bias Winding Number of Turns
ALG			358	nH/T ²	Gapped Core Effective Inductance
BM			3027	Gauss	Maximum Flux Density at PO, VMIN (BM<3000)
BP			3957	Gauss	Peak Flux Density (BP<4200)
BAC			1029	Gauss	AC Flux Density for Core Loss Curves (0.5 X Peak to Peak)
ur			2053		Relative Permeability of Ungapped Core
LG			0.11	mm	Gap Length (Lg > 0.1 mm)
BWE			16.3	mm	Effective Bobbin Width
OD			0.42	mm	Maximum Primary Wire Diameter including insulation
INS			0.06	mm	Estimated Total Insulation Thickness (= 2 * film thickness)
DIA			0.36	mm	Bare conductor diameter
AWG			28	AWG	Primary Wire Gauge (Rounded to next smaller standard AWG value)
CM			161	Cmils	Bare conductor effective area in circular mils
CMA			362	Cmils/Amp	Primary Winding Current Capacity (200 < CMA < 500)
TRANSFORMER SECONDARY DESIGN PARAMETERS (SINGLE OUTPUT EQUIVALENT)					
Lumped parameters					
ISP			1.63	Amps	Peak Secondary Current
ISRMS			0.77	Amps	Secondary RMS Current
IO			0.45	Amps	Power Supply Output Current
IRIPPLE			0.62	Amps	Output Capacitor RMS Ripple Current
CMS			153	Cmils	Secondary Bare Conductor minimum circular mils
AWGS			28	AWG	Secondary Wire Gauge (Rounded up to next larger standard AWG value)
DIAS			0.32	mm	Secondary Minimum Bare Conductor Diameter
ODS			0.78	mm	Secondary Maximum Outside Diameter for Triple Insulated Wire
INSS			0.23	mm	Maximum Secondary Insulation Wall Thickness
VOLTAGE STRESS PARAMETERS					
VDRAIN			584	Volts	Maximum Drain Voltage Estimate (Includes Effect of Leakage Inductance)
PIVS			252	Volts	Output Rectifier Maximum Peak Inverse Voltage
PIVB			65	Volts	Bias Rectifier Maximum Peak Inverse Voltage
TRANSFORMER SECONDARY DESIGN PARAMETERS (MULTIPLE OUTPUTS)					
1st output					
VO1			48	Volts	Output Voltage
IO1			0.452083 3333	Amps	Output DC Current
PO1			21.70	Watts	Output Power
VD1			1	Volts	Output Diode Forward Voltage Drop
NS1			21.00		Output Winding Number of Turns
ISRMS1			0.766	Amps	Output Winding RMS Current
IRIPPLE1			0.62	Amps	Output Capacitor RMS Ripple Current
PIVS1			252	Volts	Output Rectifier Maximum Peak Inverse Voltage
CMS1			153	Cmils	Output Winding Bare Conductor minimum circular mils



AWGS1			28	AWG	Wire Gauge (Rounded up to next larger standard AWG value)
DIAS1			0.32	mm	Minimum Bare Conductor Diameter
ODS1			0.78	mm	Maximum Outside Diameter for Triple Insulated Wire
2nd output					
VO2				Volts	Output Voltage
IO2				Amps	Output DC Current
PO2			0.00	Watts	Output Power
VD2				Volts	Output Diode Forward Voltage Drop
NS2			0.00		Output Winding Number of Turns
ISRMS2			0.000	Amps	Output Winding RMS Current
IRIPPLE2			0.00	Amps	Output Capacitor RMS Ripple Current
PIVS2			0	Volts	Output Rectifier Maximum Peak Inverse Voltage
CMS2			0	Cmils	Output Winding Bare Conductor minimum circular mils
AWGS2			N/A	AWG	Wire Gauge (Rounded up to next larger standard AWG value)
DIAS2			N/A	mm	Minimum Bare Conductor Diameter
ODS2			N/A	mm	Maximum Outside Diameter for Triple Insulated Wire
3rd output					
VO3				Volts	Output Voltage
IO3				Amps	Output DC Current
PO3			0.00	Watts	Output Power
VD3				Volts	Output Diode Forward Voltage Drop
NS3			0.00		Output Winding Number of Turns
ISRMS3			0.000	Amps	Output Winding RMS Current
IRIPPLE3			0.00	Amps	Output Capacitor RMS Ripple Current
PIVS3			0	Volts	Output Rectifier Maximum Peak Inverse Voltage
CMS3			0	Cmils	Output Winding Bare Conductor minimum circular mils
AWGS3			N/A	AWG	Wire Gauge (Rounded up to next larger standard AWG value)
DIAS3			N/A	mm	Minimum Bare Conductor Diameter
ODS3			N/A	mm	Maximum Outside Diameter for Triple Insulated Wire
Total power					
			21.7	Watts	Total Power for Multi-output section
Negative Output			N/A		If negative output exists enter Output number; eg: If VO2 is negative output, enter 2



8 Transformer Specification

Transformer Construction



Electrical Diagram

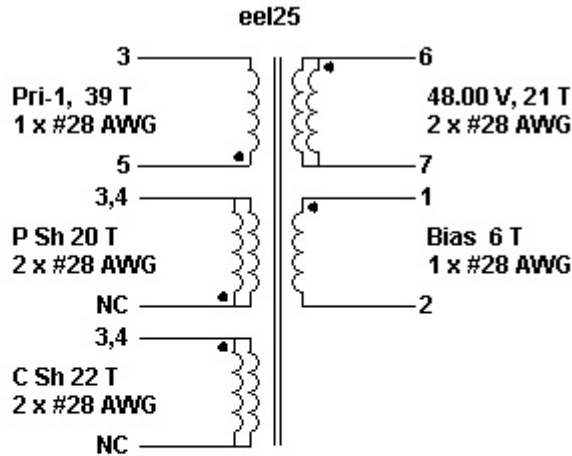

KEY

- Pri-1 = Primary Winding (Section 1)
- Pri-2 = Primary Winding (Section 2)
- C Sh = Cancellation Shield Winding
- P Sh = Primary Shield
- S Sh = Secondary Shield
- T.I.W = Triple Insulated Wire

Winding Order

Secondary Winding
Primary Balanced Shield Winding
Bias Winding
Primary Winding (Section 1)
Cancellation Shield Winding

Core Information

Core Type	eel25
Core Material	NC-2H or Equivalent
Estimated Gap length, mm	0.110
Gapped Effective Inductance, nH/t ²	358
Primary Inductance, uH	532



Bobbin Information (Manual Input)

Bobbin Reference	Generic, 5 pri. + 5 sec.
Bobbin Orientation	Horizontal
Number of Primary pins	5
Number of Secondary pins	5
Margin on Left, mm	3.0
Margin on Right, mm	3.0

Primary Winding (Manual Input)

Parameter	Section 1
Number of Turns	39
Wire Size, AWG	28
Filar	1
Layers	0.88
Start Pin(s)	5
Termination Pin(s)	3

BIAS Winding (Manual Input)

Parameter	Value
Number of Turns	6
Wire Size, AWG	28
Filar	1
Layers	0.13
Start Pin(s)	1
Termination Pin(s)	2

Shield Information

Parameter	Primary	Cancellation
Number of Turns	20	22
Wire Size, AWG	28	28
Filar	2	2
Layers	0.90	0.99
Start Pin(s)	NC	3,4
Termination Pin(s)	3,4	NC

Secondary Winding (Manual Input)

Parameter	Output 1
Spec Voltage, V	48.00
Spec Current, A	0.45
Actual Voltage, V	48.00
Number of Turns	21
Wire Size, AWG	28
Filar	2
Layers	0.94
Start Pin(s)	6
Termination Pin(s)	7



Winding Instruction

Use 3.0 mm margin (item [3]) on the left side. Use 3.0 mm margin (item [3]) on the right side.

Cancellation Shield Winding

Start on pin(s) 3,4 and wind 22 turns (x 2 filar) of item [6]. in exactly 1 layer. Leave this end of cancellation shield winding not connected. Bend the end 90 deg and cut the wire in the middle of the bobbin.

Add 1 layer of tape, item [4], to secure the winding in place.

Primary Winding

Start on pin(s) 5 and wind 39 turns of item [6] in 1.00 layer(s) from left to right. Finish winding on pin(s) 3.

Add 1 layer of tape, item [4], for insulation.

Bias Winding

Start on pin(s) 1 and wind 6.0 turns (x 1 filar) of item [6]. Spread the winding evenly across entire bobbin. Finish on pin(s) 2.

Add 1 layer of tape, item [4], for insulation.

Primary Balanced Shield Winding

Start on any (temp) pin on the secondary side and wind 20 turns (x 2 filar) of item [6]. Spread the winding evenly across entire bobbin. Finish this winding on pin(s) 3,4.

Cut out wire connected to temp pin on secondary side. Leave this end of primary shield winding not connected. Bend the end 90 deg and cut the wire in the middle of the bobbin.

Add 3 layers of tape, item [4], for insulation.

Secondary Winding

Start on pin(s) 6 and wind 21 turns (x 2 filar) of item [6]. Spread the winding evenly across entire bobbin. Finish on pin(s) 7.

Add 2 layers of tape, item [4], for insulation.

Core Assembly

Assemble and secure core halves. Item [1].

Varnish

Dip varnish uniformly in item [5]. Do not vacuum impregnate.

Comments

1. **Pins 8 through 10 on the secondary side are not connected to any electrical node.**
2. **Pins 3 and 4 should be electrically connected**

Materials

<i>Item</i>	<i>Description</i>
[1]	Core: eel25, NC-2H or Equivalent, gapped for ALG of 358 nH/t²
[2]	Bobbin: Generic, 5 pri. + 5 sec.
[3]	Tape: Polyester web 3.0 mm wide
[4]	Barrier Tape: Polyester film 22.30 mm wide
[5]	Varnish
[6]	Magnet Wire: 28 AWG, Solderable Double Coated



Electrical Test Specifications

<i>Parameter</i>	<i>Condition</i>	<i>Spec</i>
Electrical Strength, VAC	60 Hz 1 minute, from pins 3 - 5 to pins 6 - 10.	3000
Nominal Primary Inductance, uH	Measured at 1 V pk-pk, typical switching frequency, between pin 3 to pin 5, with all other Windings open.	586 +/- 10%
Primary Leakage, uH	Measured between Pin 3 to Pin 5, with all other Windings shorted.	17.57 Goal



9 Performance

9.1 Efficiency

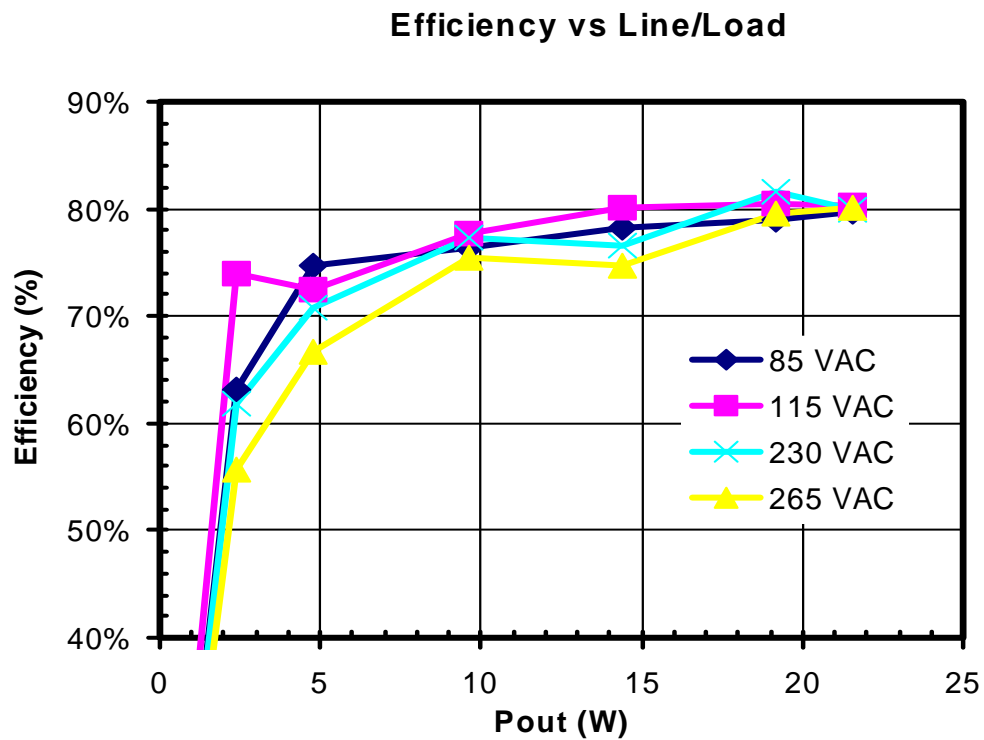

Figure 5 – Efficiency vs. Input Voltage and Output Load, Room Temperature



9.2 Regulation vs. Load

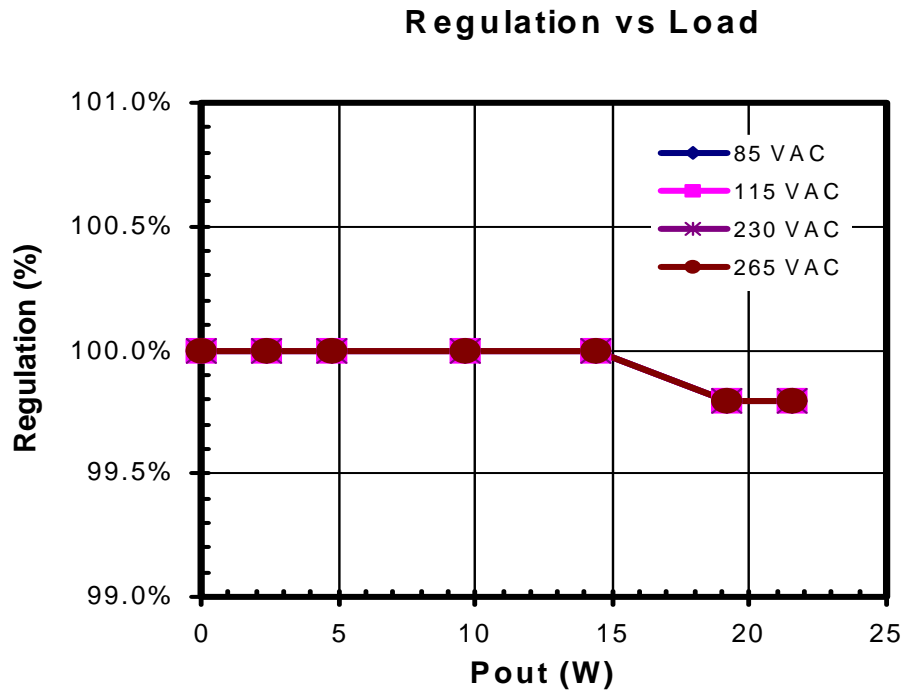

Figure 6 – Output Regulation vs. Output Load, Room Temperature



9.3 Regulation vs. Line

Regulation vs Line

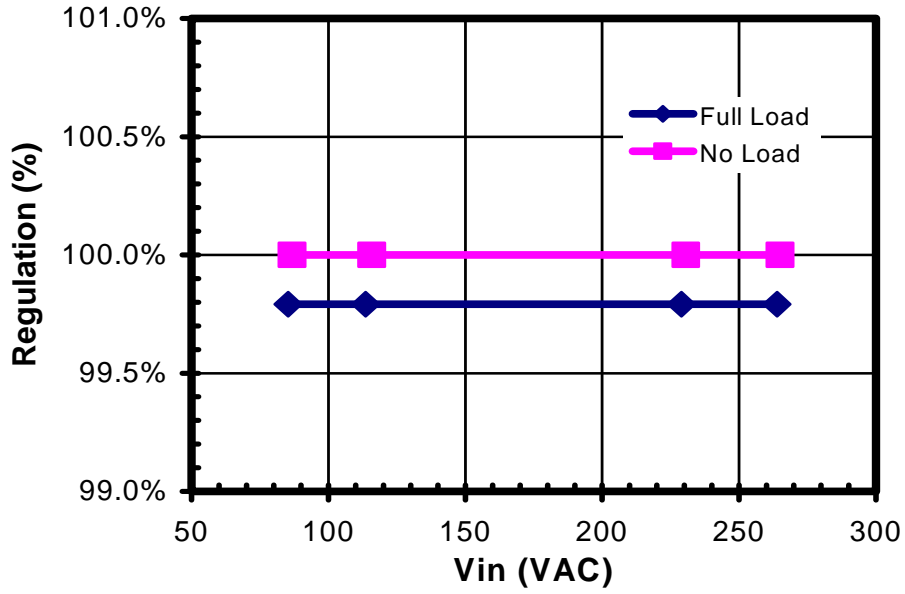

Figure 7 – Output Regulation vs. Input Line Voltage, Room Temperature



9.4 Raw Performance Data

Load was applied at the end of a 1 ft long Ethernet cable connected to the connector J6. The load was applied using an electronic load. The output voltage was measurement at the end of this cable.

Vin (DC)	Pin (A)	Vout1 (V)	Iout1 (A)	%Vout1 (%)	Iin (A)	Eff (%)	Iin (A)	Pout (W)
86.79	0.828	48	0	100.0%	0.010	0.0%	0.000	0.0
86.42	3.802	48	0.05	100.0%	0.044	63.1%	0.001	2.4
86.8	6.432	48	0.1	100.0%	0.074	74.6%	0.001	4.8
86.39	12.573	48	0.2	100.0%	0.146	76.4%	0.002	9.6
85.95	18.42	48	0.3	100.0%	0.214	78.2%	0.002	14.4
85.46	24.24	47.9	0.4	99.8%	0.284	79.0%	0.003	19.2
85.22	27.03	47.9	0.45	99.8%	0.317	79.7%	0.004	21.6
115.83	0.7734	48	0	100.0%	0.007	0.0%	0.000	0.0
115.74	3.2452	48	0.05	100.0%	0.028	74.0%	0.000	2.4
115.13	6.629	48	0.1	100.0%	0.058	72.4%	0.001	4.8
114.31	12.346	48	0.2	100.0%	0.108	77.8%	0.001	9.6
113.9	17.985	48	0.3	100.0%	0.158	80.1%	0.001	14.4
113.81	23.794	47.9	0.4	99.8%	0.209	80.5%	0.002	19.2
113.54	26.831	47.9	0.45	99.8%	0.236	80.3%	0.002	21.6
230.56	0.9012	48	0	100.0%	0.004	0.0%	0.000	0.0
230.1	3.878	48	0.05	100.0%	0.017	61.9%	0.000	2.4
230	6.78	48	0.1	100.0%	0.029	70.8%	0.000	4.8
229.41	12.405	48	0.2	100.0%	0.054	77.4%	0.000	9.6
229.71	18.825	48	0.3	100.0%	0.082	76.5%	0.000	14.4
229.39	23.478	47.9	0.4	99.8%	0.102	81.6%	0.000	19.2
228.87	26.994	47.9	0.45	99.8%	0.118	79.9%	0.001	21.6
265	0.9906	48	0	100.0%	0.004	0.0%	0.000	0.0
265.46	4.317	48	0.05	100.0%	0.016	55.6%	0.000	2.4
265.67	7.205	48	0.1	100.0%	0.027	66.6%	0.000	4.8
264.92	12.731	48	0.2	100.0%	0.048	75.4%	0.000	9.6
264.66	19.287	48	0.3	100.0%	0.073	74.7%	0.000	14.4
264.4	24.105	47.9	0.4	99.8%	0.091	79.5%	0.000	19.2
263.88	26.931	47.9	0.45	99.8%	0.102	80.0%	0.000	21.6
Max		48	0.0%	100.0%	0.317	81.6%		21.6
Min		47.9	-0.2%	99.8%	0.004	0.0%		2.4
Delta		0.1	0.2%	0.2%	0.313	81.6%		



10 Waveforms

10.1 Drain Current and Voltage

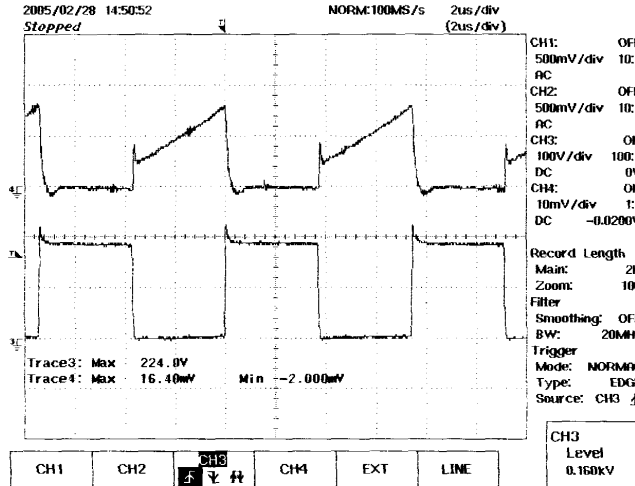

Figure 8 – 85 VAC, full load
Upper Ch3: Drain Voltage 100 V,
Lower Ch4: Drain Current 0.5 A / Div,
2 µs / div

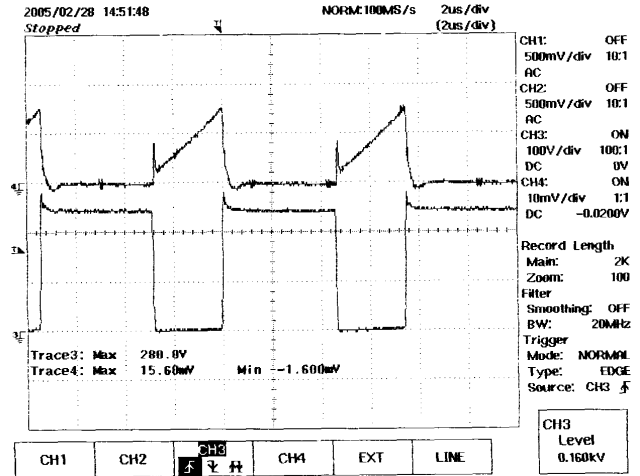

Figure 9 – 115 VAC, full load
Upper Ch3: Drain Voltage 100 V,
Lower Ch4: Drain Current 0.5 A / Div,
2 µs / div

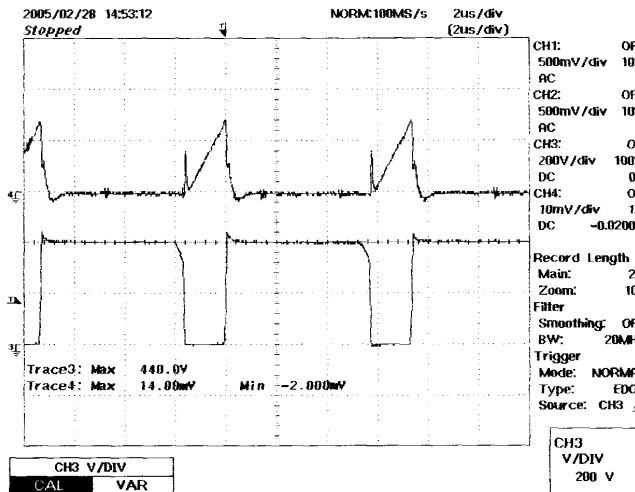

Figure 10 – 230 VAC, full load
Upper Ch3: Drain Voltage 200 V,
Lower Ch4: Drain Current 0.5 A / Div,
2 µs / div

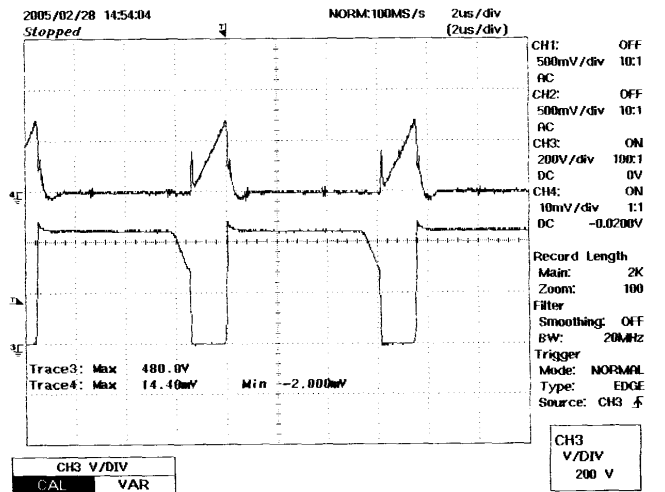

Figure 11 – 265 VAC, full load
Upper Ch3: Drain Voltage 200 V,
Lower Ch4: Drain Current 0.5 A / Div,
2 µs / div



10.2 Output Transient Load Response

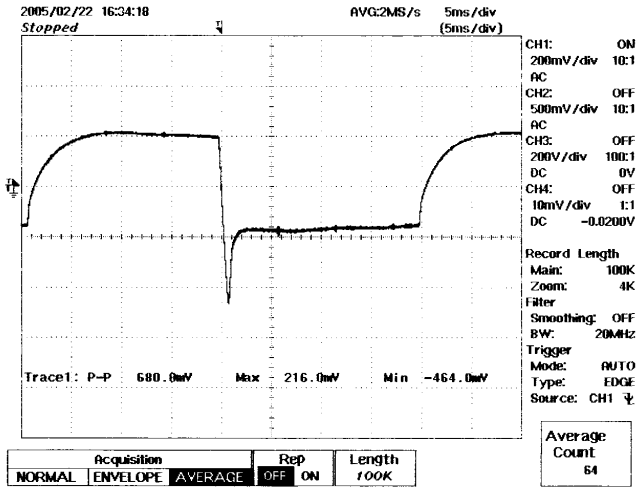

Figure 12 – 115 VAC, (48 V 0.23 A to 0.45 A step)
48 V Output Voltage
200 mV / Div, 5 ms / div

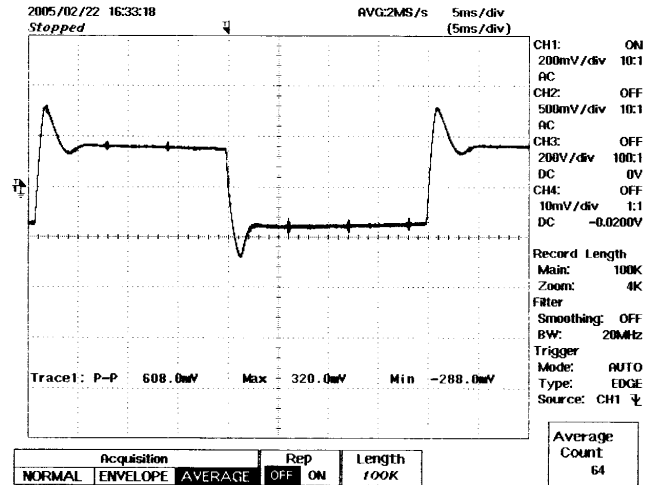

Figure 13 – 230 VAC, (48 V 0.23 A to 0.45 A step)
48 V Output Voltage
200 mV / Div, 5 ms / div



10.3 Output Ripple Voltage

It can be seen from the waveforms below that the power supply comfortably meets the output ripple specifications. This is possible even without the need for an output inductor.

Measurements made at the end of an Ethernet cable connected to J6. The voltage measurement included a 0.1 uF ceramic capacitor in parallel with a 1 uF / 50 V electrolytic capacitor, at point of measurement (end of the cable).

10.4 Switching Ripple

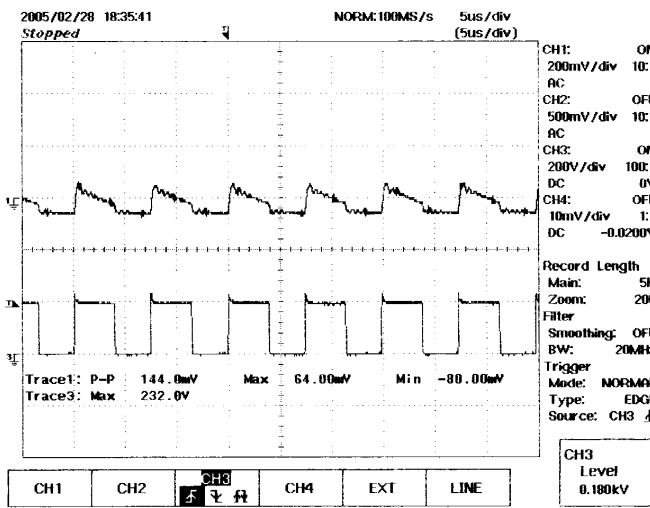

Figure 14 – 85 VAC, Full Load
CH1: 48 V Output Ripple, 200 mV,
CH3: Drain Voltage, 200 V,
5 μ s / div

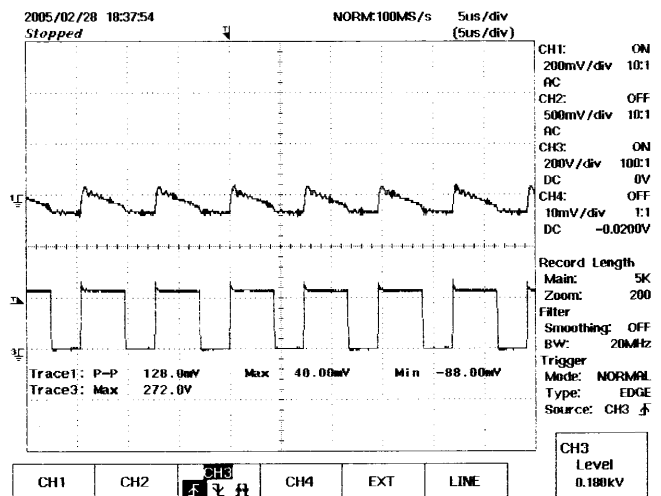

Figure 15 – 115 VAC, Full Load
CH1: 48 V Output Ripple, 200 mV,
CH3: Drain Voltage, 200 V,
5 μ s / div



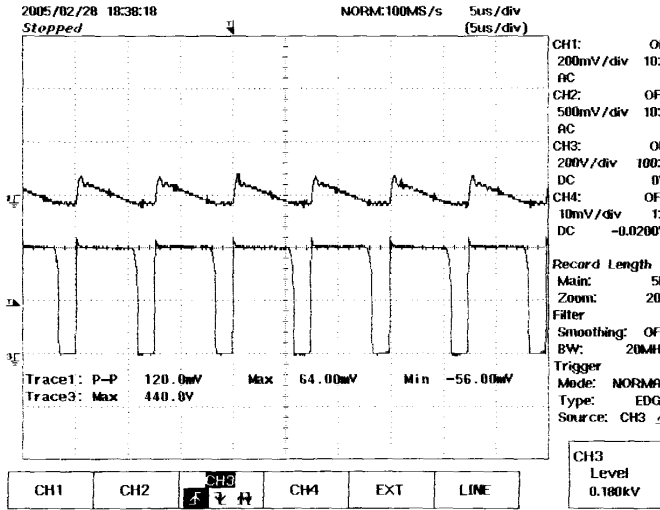

Figure 16 – 230 VAC, Full Load
CH1: 48 V Output Ripple, 200 mV,
CH3: Drain Voltage, 200 V,
5 μ s / div

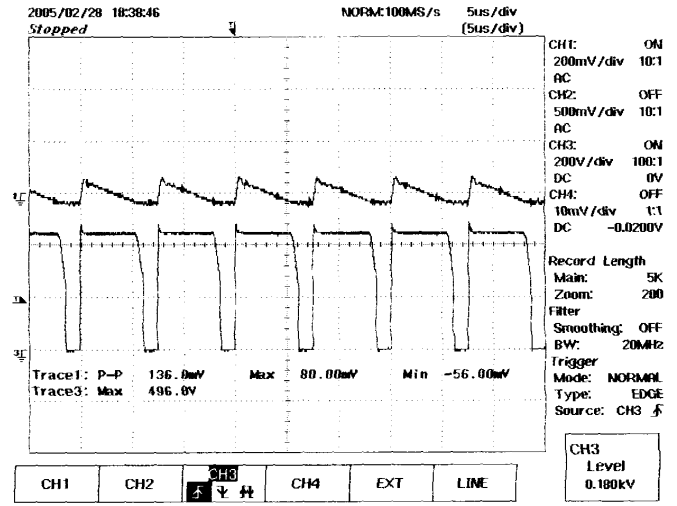

Figure 17 – 265 VAC, Full Load
CH1: 48 V Output Ripple, 200 mV,
CH3: Drain Voltage, 200 V,
5 μ s / div

10.5 Line Frequency Ripple

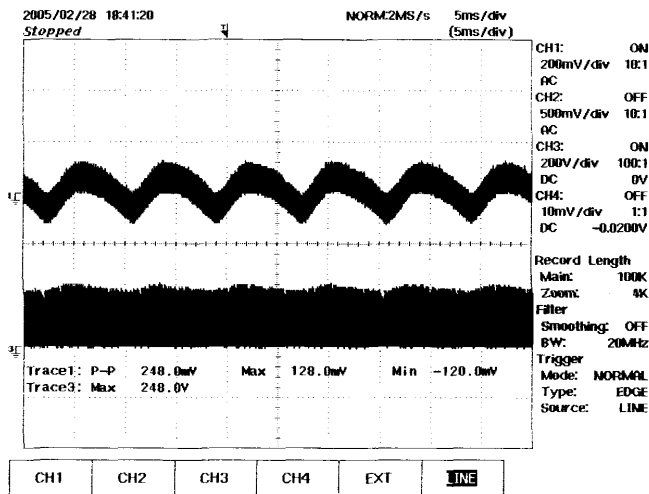

Figure 18 – 85 VAC, Full Load
CH1: 48 V Output Ripple, 200 mV,
CH3: Drain Voltage, 200 V,
5 ms / div

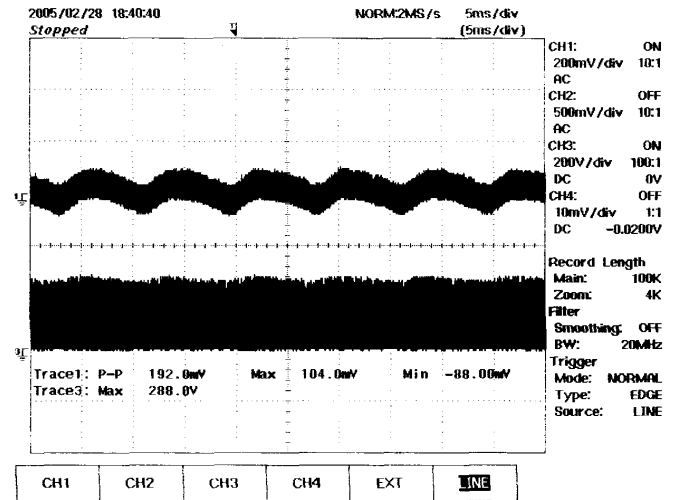

Figure 19 – 115 VAC, Full Load
CH1: 48 V Output Ripple, 200 mV,
CH3: Drain Voltage, 200 V,
5 ms / div

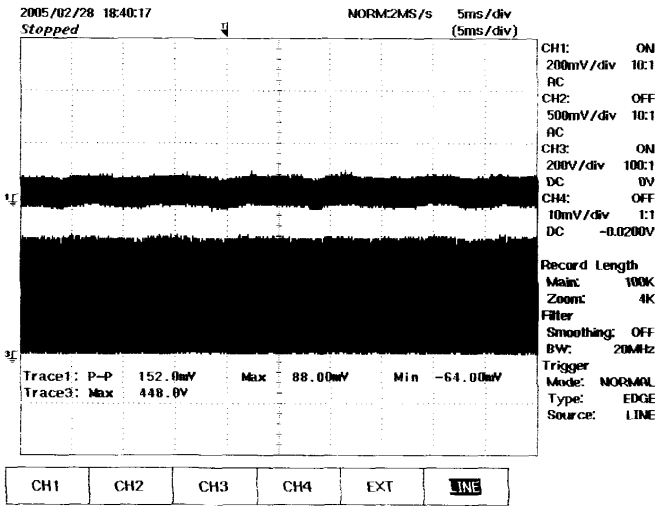

Figure 20 – 230 VAC, Full Load
CH1: 48 V Output Ripple, 200 mV,
CH3: Drain Voltage, 200 V,
5 ms / div

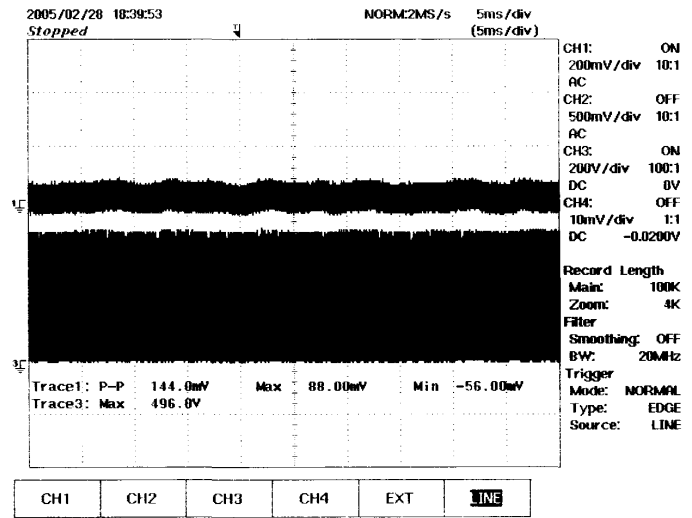

Figure 21 – 265 VAC, Full Load
CH1: 48 V Output Ripple, 200 mV,
CH3: Drain Voltage, 200 V,
5 ms / div



10.6 Output Voltage Shutdown Profile

The results below show that the power supply comfortably meets the power-supply hold-up requirements of the specification.

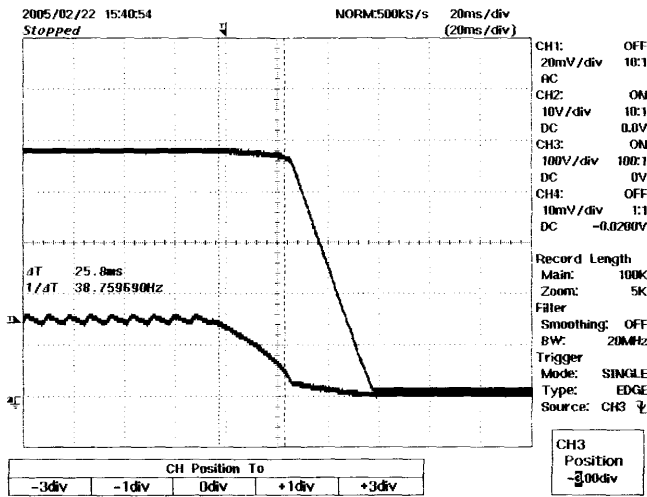

Figure 22 – Shutdown Profile at Full Load, 120 VAC
Upper Ch1: 48 V output, 10 V / div,
Lower Ch3: Bus Voltage 100 V / div,
20 ms / div.

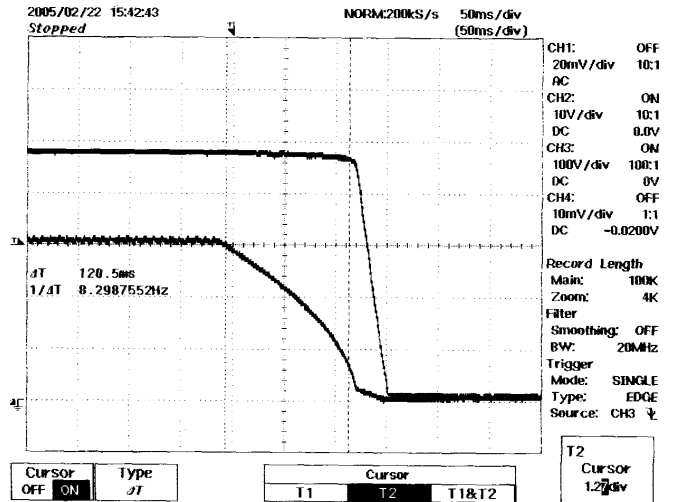

Figure 23 – Shutdown Profile at Full Load, 120 VAC
Upper Ch1: 48 V output, 10 V / div,
Lower Ch3: Bus Voltage 100 V / div,
20 ms / div.



11 Thermal Test

The thermal measurements were made at 85 VAC (which corresponds to the worst case efficiency of the power supply). Ambient temperature of the oven was 40°C. The power supply was connected to an electronic load (external to the chamber). A cardboard box was used around the power supply to prevent significant airflow. The whole setup was saturated at 40°C for an hour before beginning measurements.

11.1 Thermal Performance

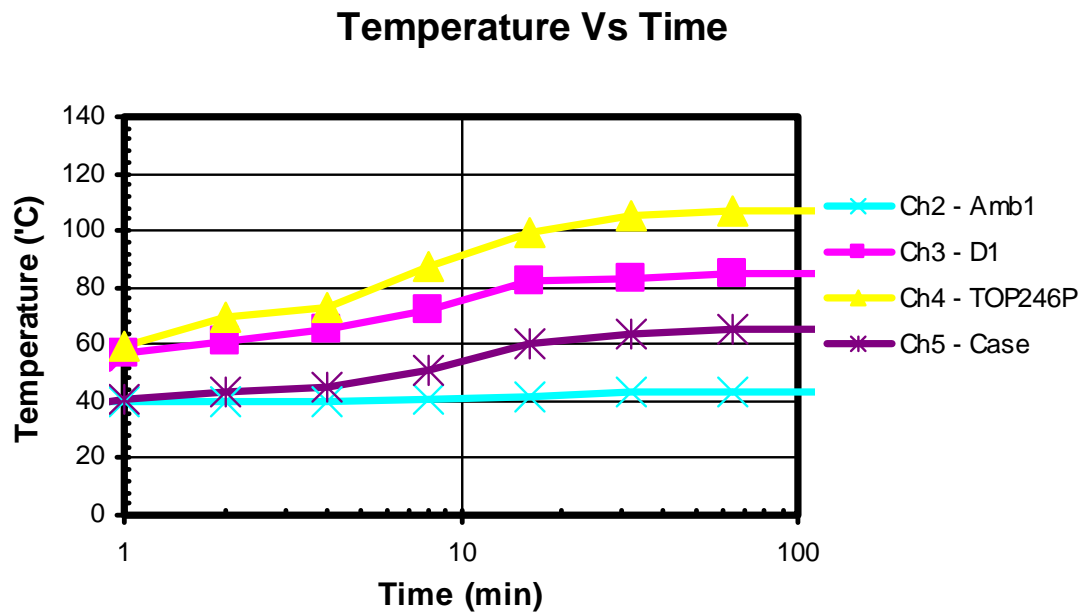

Figure 24 – Thermal Performance of Key Power Supply Components

Delta Time	Ch2 Amb1	Ch3 D1	Ch4 TOP246P	Ch5 CASE
0.1	40	40	40	40
0.9	40	52	55	40
1	40	57	59	41
2	40	61	70	43
4	40	65	73	45
8	41	72	87	51
16	42	82	99	60
32	43	83	105	64
64	43	85	107	65
128	43	85	107	65

Figure 25 – Raw Test Data



12 Conducted EMI

The EMI was tested with and without the output connected to earth-ground. Load was connected through an Ethernet cable to a resistive load (100 ohms).

12.1 Conducted EMI Performance

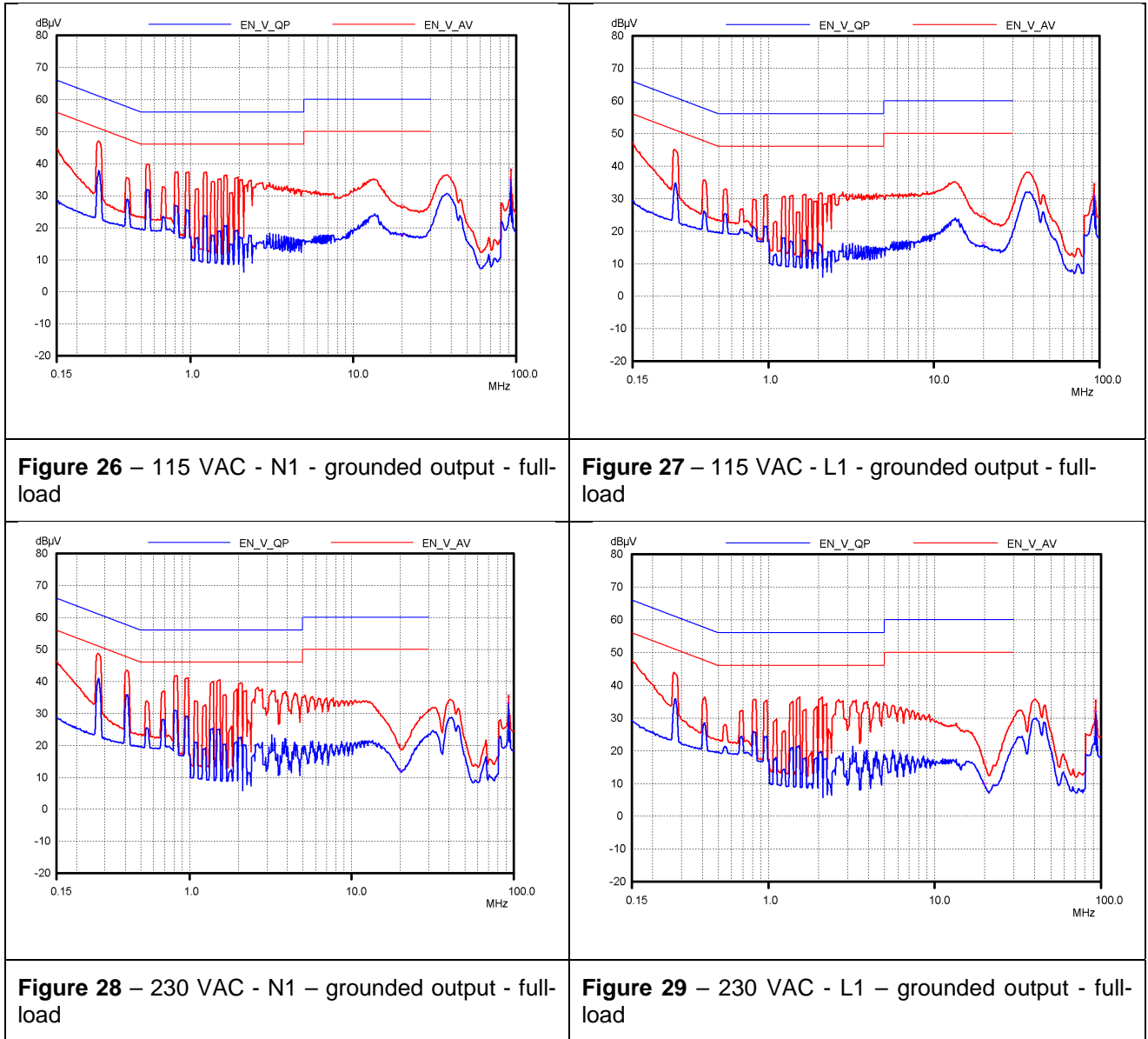

13 Revision History

Date	Author	Revision	Description & changes	Reviewed
September 12, 2005	RM	1.0	First Release	VC / AM



For the latest updates, visit our Web site: www.powerint.com

Power Integrations may make changes to its products at any time. Power Integrations has no liability arising from your use of any information, device or circuit described herein nor does it convey any license under its patent rights or the rights of others. POWER INTEGRATIONS MAKES NO WARRANTIES HEREIN AND SPECIFICALLY DISCLAIMS ALL WARRANTIES INCLUDING, WITHOUT LIMITATION, THE IMPLIED WARRANTIES OF MERCHANTABILITY, FITNESS FOR A PARTICULAR PURPOSE, AND NON-INFRINGEMENT OF THIRD PARTY RIGHTS.

PATENT INFORMATION

The products and applications illustrated herein (including circuits external to the products and transformer construction) may be covered by one or more U.S. and foreign patents or potentially by pending U.S. and foreign patent applications assigned to Power Integrations. A complete list of Power Integrations' patents may be found at www.powerint.com.

The PI Logo, **TOPSwitch**, **TinySwitch**, **LinkSwitch**, and **EcoSmart** are registered trademarks of Power Integrations. **PI Expert** and **DPA-Switch** are trademarks of Power Integrations.

© Copyright 2004, Power Integrations.

Power Integrations Worldwide Sales Support Locations

WORLD HEADQUARTERS

5245 Hellyer Avenue,
San Jose, CA 95138, USA
Main: +1-408-414-9200
Customer Service:
Phone: +1-408-414-9665
Fax: +1-408-414-9765
e-mail:
usasales@powerint.com

GERMANY

Rueckertstrasse 3,
D-80336, Munich, Germany
Phone: +49-895-527-3910
Fax: +49-895-527-3920
e-mail: eurosales@powerint.com

JAPAN

Keihin-Tatemono 1st Bldg.
12-20 Shin-Yokohama,
2-Chome,
Kohoku-ku, Yokohama-shi,
Kanagawa 222-0033, Japan
Phone: +81-45-471-1021
Fax: +81-45-471-3717
e-mail:
japansales@powerint.com

TAIWAN

17F-3, No. 510,
Chung Hsiao E. Rd., Sec. 5,
Taipei, Taiwan 110, R.O.C.
Phone: +886-2-2727-1221
Fax: +886-2-2727-1223
e-mail:
taiwansales@powerint.com

CHINA (SHANGHAI)

Rm 807, Pacheer,
Commercial Centre,
555 Nanjing West Road,
Shanghai, 200041, China
Phone: +86-21-6215-5548
Fax: +86-21-6215-2468
e-mail:
chinasales@powerint.com

INDIA (TECHNICAL SUPPORT)

Innovatech
261/A, Ground Floor
7th Main, 17th Cross,
Sadashivanagar
Bangalore, India, 560080
Phone: +91-80-5113-8020
Fax: +91-80-5113-8023
e-mail: indiasales@powerint.com

KOREA

8th Floor, DongSung Bldg.
17-8 Yoido-dong,
Youngdeungpo-gu,
Seoul, 150-874, Korea
Phone: +82-2-782-2840
Fax: +82-2-782-4427
e-mail:
koreasales@powerint.com

UK (EUROPE & AFRICA HEADQUARTERS)

1st Floor, St. James's House
East Street
Farnham, Surrey GU9 7TJ
United Kingdom
Phone: +44-1252-730-140
Fax: +44-1252-727-689
e-mail: eurosales@powerint.com

CHINA (SHENZHEN)

Rm# 1705, Bao Hua Bldg.
1016 Hua Qiang Bei Lu,
Shenzhen, Guangdong,
518031, China
Phone: +86-755-8367-5143
Fax: +86-755-8377-9610
e-mail:
chinasales@powerint.com

ITALY

Via Vittorio Veneto 12, Bresso,
Milano,
20091, Italy
Phone: +39-028-928-6001
Fax: +39-028-928-6009
e-mail: eurosales@powerint.com

SINGAPORE

51 Newton Road,
#15-08/10 Goldhill Plaza,
Singapore, 308900
Phone: +65-6358-2160
Fax: +65-6358-2015
e-mail:
singaporesales@powerint.com

APPLICATIONS HOTLINE

World Wide +1-408-414-9660

APPLICATIONS FAX

World Wide +1-408-414-9760

ER or EPR template – Rev 3.6 – Single sided

