



Design Example Report

Title	<i>2.5W Adapter using LNK520P</i>
Specification	Input: 90-265Vac Output: 5.5V / 450mA
Application	Cell Phone Charger
Author	Power Integrations Applications Department
Document Number	DER-39
Date	May 13, 2004
Revision	1.0

Summary and Features

- No optocoupler
- Provides sloping output VI characteristic, making it an ideal low standby power replacement for a linear transformer
- Uses an EF12.6 transformer
- No Y1 safety capacitor required, giving very low earth leakage current
- Meets CISPR-22B with large margin
- Low component count
- Less than 300mW standby consumption at 230 VAC
- High efficiency

The products and applications illustrated herein (including circuits external to the products and transformer construction) may be covered by one or more U.S. and foreign patents or potentially by pending U.S. and foreign patent applications assigned to Power Integrations. A complete list of Power Integrations' patents may be found at www.powerint.com.

Table Of Contents

1	Introduction.....	3
2	Power Supply Specification.....	4
3	Schematic.....	5
4	Circuit Description.....	6
4.1	Input EMI Filtering.....	6
4.2	LinkSwitch Operation.....	6
4.3	Clamp and Feedback Components.....	7
4.4	Output Stage.....	8
5	PCB Layout.....	9
6	Bill Of Materials.....	10
7	Transformer Specification.....	11
7.1	Transformer Winding.....	11
7.2	Electrical Specifications.....	11
7.3	Transformer Construction.....	12
7.4	Winding Instructions.....	12
7.5	Materials.....	13
7.6	Design Notes.....	13
8	Performance Data.....	14
8.1	Efficiency.....	14
8.2	No-load Input Power.....	15
8.3	Line and Load Regulation.....	15
9	Thermal Performance.....	17
10	Waveforms.....	18
10.1	Drain Voltage and Current, Normal Operation.....	18
10.2	Output Ripple Measurements.....	19
10.2.1	Ripple Measurement Technique.....	19
10.2.2	Measurement Results.....	20
11	Conducted EMI.....	21
12	Revision History.....	23

Important Note:

Although this board is designed to satisfy safety isolation requirements, the engineering prototype has not been agency approved. Therefore, all testing should be performed using an isolation transformer to provide the AC input to the prototype board.

Design Reports contain a power supply design specification, schematic, bill of materials, and transformer documentation. Performance data and typical operation characteristics are included. Typically only a single prototype has been built.



1 Introduction

This document is an engineering report giving performance characteristics of a prototype 2.5W charger/adaptor optimized to replace a linear transformer. The supply uses LinkSwitch (LNK520P) – an integrated IC combining a 700V high voltage MOSFET, PWM controller, start-up, thermal shutdown, and fault protection circuitry.

Using LNK520P in the high side switching gives a sloping VI-characteristic with no optocoupler. The design used no Y-cap, but has very low EMI emissions.

This document contains the power supply specification, schematic, bill of materials, transformer documentation, and performance data.



Figure 1 – Populated Circuit Board Photograph



2 Power Supply Specification

Description	Symbol	Min	Typ	Max	Units	Comment
Input						
Voltage	V_{IN}	90		265	Vac	2 Wire- No protective ground
Frequency	f_{LINE}	47	50/60	64	Hz	
No-load Input Power (230Vac)				0.3	W	
Output						
Output Voltage 1	V_{OUT}		5.5		V	see Figure 1
Output Current 1	I_{OUT}		0.45		A	see Figure 1
Continuous Output Power	P_{OUT}		2.5		W	
Efficiency	η		67		%	At full load @ 230V
Operating Temperature	T_{AMB}	-5		50	C	
Conducted EMI	CISP22B/EN55022B with Artificial hand connected to output return					

Table 1 – Typical Power Supply Specification

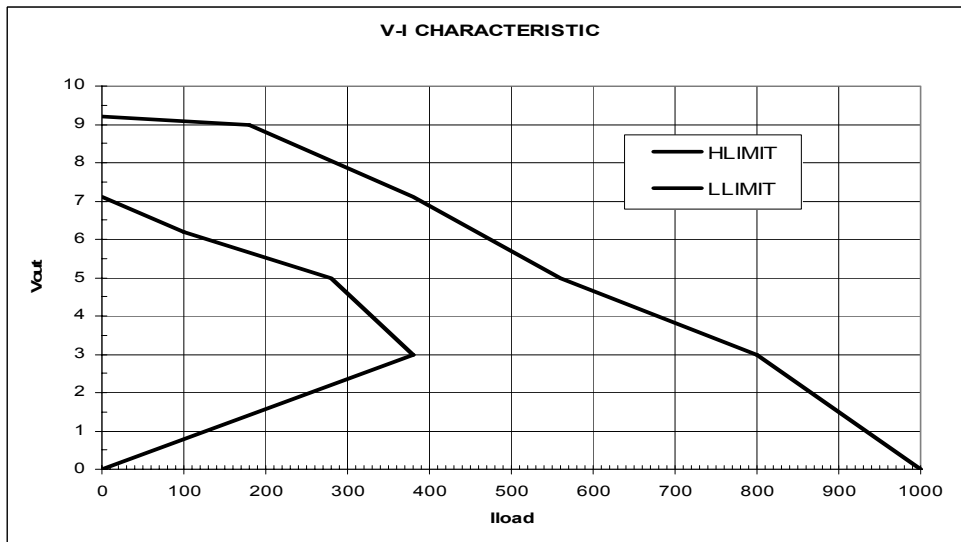

Figure 2 - Output V-I Characteristic Envelope Specification



3 Schematic

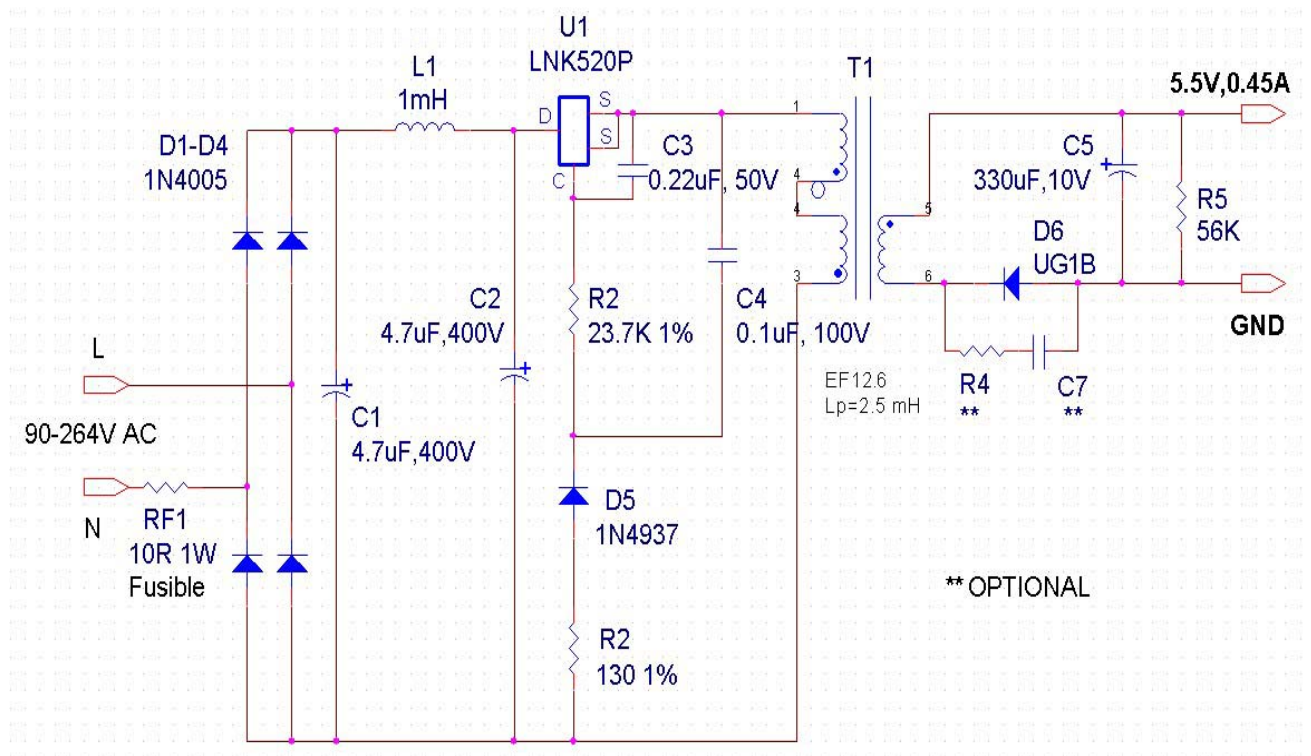

Figure 3 – Schematic

** optional parts are not installed on the board



4 Circuit Description

The schematic shown in the Figure 3 provides a CV/CC (constant voltage and constant current) output characteristic form the universal input voltage range of 90 VAC to 265 VAC. The nominal peak power point at the transition from CC to CV is 5.5 V at 450 mA. The output envelope specification is shown is Figure 2.

4.1 Input EMI Filtering

The incoming AC is rectified and filtered by D1-4, C1 and C2. Resistor RF1 is a flameproof fusible type to protect against fault conditions and is requirement to meet safety agency fault testing. This component should be a wire wound type to withstand input current surges while the input capacitors charge on application of power or during withstand line-transient testing. Metal film type resistors are not recommended, they do not have the transient dissipation capabilities required and may fail prematurely in the field.

The input capacitance is split between C1 and C2 to allow an input pi filter to be formed by L1. This filters noise associated with the supply to meet EN55022B/CSPR 22 B and FCC B conducted EMC limits, even when no Y safety capacitor is used.

4.2 LinkSwitch Operation

When the power is applied to the supply, high voltage DC appears at the DRAIN pin of the LINKSWITCH (U1). The CONTROL pin capacitor C3 is then charged through a switched high voltage current source connected internally between the DRAIN and CONTROL pins. When the CONTROL pin voltage reaches approximately 5.7 V relative to the SOURCE pin, the internal current source is turned off. The internal control circuitry is activated and the high voltage internal MOSFET starts to switch, using the energy in C3 to power the IC,

As the current ramps in the primary of the flyback transformer T1, energy is stored. This energy is delivered to the output when the mosfet turns off each cycle.

The secondary of the transformer is rectified and filtered by D6 and C5 to provide the DC output to the load.

Control of the output characteristic is entirely sensed from the primary-side by monitoring the primary-side VOR (voltage output reflected). While the output diode is conducting, the voltage across the transformer primary is equal to the output voltage plus diode drop multiplied by the turns ratio of the transformer. Since the LinkSwitch is connected on the high side of the transformer, VOR can be sensed directly.



Diode D5 and capacitor C4 form the primary clamp network. The voltage held across C4 is essentially the VOR with an error due to the parasitic leakage inductance.

The LinkSwitch has three operating modes determined by the current flowing into the CONTROL pin.

During start-up, as the output voltage, and therefore the reflected voltage and voltage across C4 increases, the feedback current increases from 0 to approximately 2mA through R1 in the CONTROL pin. The internal current limit is increased during this period until reaching 100%, providing an approximately constant output current.

Once the output voltage reaches the regulated CV value, the output voltage is regulated through control of the duty cycle. As the current into the CONTROL pin exceeds approximately 2 mA, the duty cycle begins to reduce, reaching 30% at a CONTROL pin current of 2.3mA.

If the duty cycle reaches a 3% threshold, the switching frequency is reduced, which reduces energy consumption under light or no load conditions.

As the output load increases beyond the peak power point (defined by $1/2LI^2f$) and the output voltage and the VOR falls, the reduced CONTROL pin current will lower the internal current providing an approximately constant current characteristic. If the output load is further increased and the output voltage fall further to below a CONTROL pin current of 1mA, the CONTROL pin capacitor C3 will discharge and the supply will enter auto-restart.

The transformer is designed to always be discontinuous; that is all the energy is transferred to the load during the mosfet off time.

4.3 Clamp and Feedback Components

Diode D5 should either be a fast or ultra-fast type to prevent the voltage across the LinkSwitch from reversing and ringing below ground. A fast diode is preferred, being lower cost. Leakage inductance is filtered by R2.

Capacitor C4 is typically fixed at 0.1uF and should be rated above the VOR and be stable with both temperature and applied voltage. Low-cost, Metallized plastic film capacitors are ideal; high value, low-cost ceramic capacitors are not recommended. Dielectrics used for these capacitors such as Z5U and Y5U are not stable and can cause output instability as their value changes with voltage and temperature.



R1 was selected to program the peak power point to be 450mA when a transformer with a nominal inductance value was used.

C3 sets the auto-restart period and also the time the output has to reach regulation before entering auto-restart from start-up. If a battery load is used then a value of 0.22uF is typical. However, if the supply is required to start into a resistive load then this should be increased to 1uF to ensure enough time during start-up to bring the output into regulation. The type of capacitor is not critical; either a small ceramic or electrolytic may be used with a voltage rating of 10V or more.

4.4 Output Stage

Diode D6 should be rated for 80% of applied reverse voltage and thermally for average current multiplied by forward voltage at maximum ambient.

A snubber series RC across D6 may be fitted to improved radiated EMI performance.

Capacitor C5 should be rated for output voltage and ripple current. Depending on the application, the designer may choose not to derate for ripple current. If the application is battery charging of equipment such as PDA's or cell phones, the duty cycle of operation at high ripple current is likely to be low, perhaps only 1 hour per day. In this case the capacitor temperature can be allowed to rise significantly during charging without concern for the overall lifetime.

Resistor R8 acted as preload to prevent the output from exceeding the maximum output voltage limit as specified in Figure 3 at no-load and high line. Otherwise a preload is not necessary.



5 PCB Layout

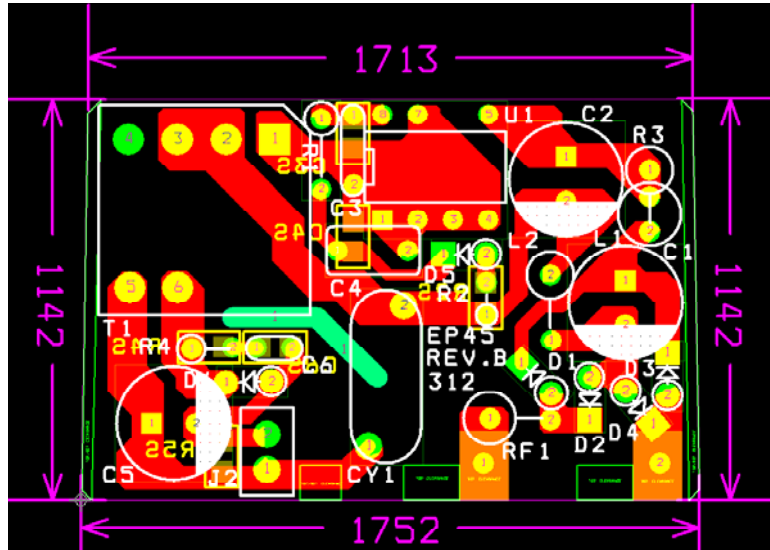

Figure 4 - PCB Layout and Dimensions (0.001 inch)



6 Bill Of Materials

Item	Quantity	Reference	Part Description
1	2	C1, C2	4.7uF, 400V
2	1	C3	0.22uF, 25V, X7R ceramic
3	1	C4	0.1uF, 100V, X7R ceramic
4	1	C5	330uF, 10V Low ESR E-cap Panasonic FC series
5	4	D1, D2, D3, D4	1N4005, 1A, 600V
6	1	D5	1N4937, 1A, 600V 200nS, Fast Rectifier
7	1	D6	UG1B, 1A, 100V, 15nS Ultra Fast Rectifier
8	1	L1	1mH Inductor- Tokin part #SBCP-47HY102B
9	1	RF1	10 ohm, 1W, Fusible- Vitrohm 253-4 Series
10	1	R2	130 ohms, 1% 0603 SMD resistor
11	1	R1	23.7 Kohm 1%; 1/4W resistor
12	1	R5	56 Kohm; 0603 SMD resistor
3	1	T1	Custom EF12.6 – Core & Bobbin
14	1	U1	LINK520P- High Voltage IC; Power Integrations, Inc
15	1	PCB	FR1 – 1oz copper DIM: 1.7" x 1.1"; 1.0mm thick



7 Transformer Specification

7.1 Transformer Winding

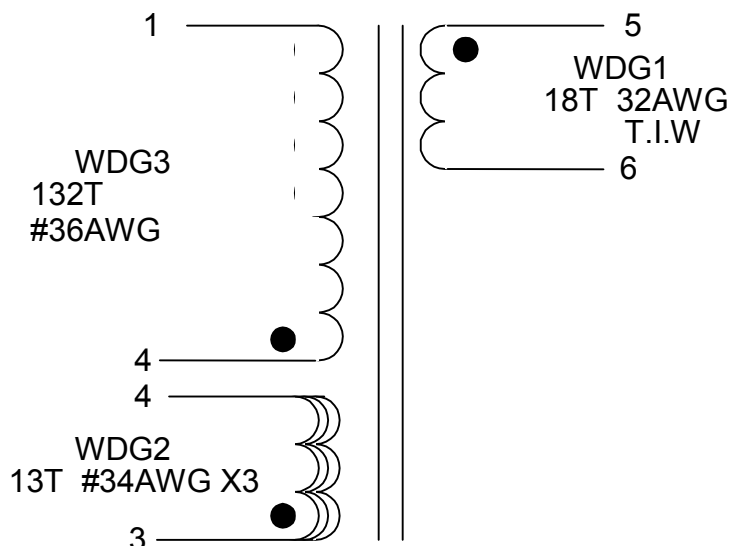

Figure 5 – Transformer Schematic EF12.6

7.2 Electrical Specifications

Electrical Strength	60Hz 1minute, from Pins 1-4 to Pins 5-6	3 kV for 1 minute
Primary Inductance (Pin 1 -Pin 3 @ 42KHZ)	All windings open	2450 uH – 2700uH
Primary Leakage Inductance @42KHZ	L_k with pins 5-6 shorted	< 60 uH

7.3 Transformer Construction

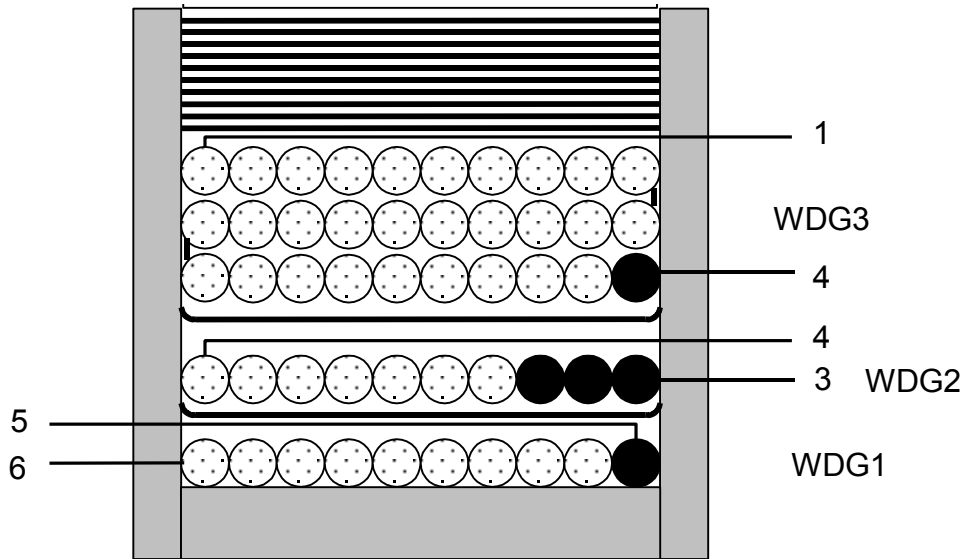

Figure 6 – Transformer Cross-section EF12.6

7.4 Winding Instructions

Place the bobbin on the winding machine with pins 1-4 on the right side. Winding should be in forward direction.

WDG1: Secondary Winding	Start at pin 4 temporarily. Wind 18 turns of item 5(#32AWG T.I.W.) from right to left with tight tension. Wind uniformly in a single layer across entire width of bobbin. Finish on pin 6.
Basic Insulation	Secure winding partially using item 6.
WDG1: Secondary Winding	Change the start pin connection of secondary winding from pin 4 to pin 5.
Basic Insulation	Continue winding the tape previously placed for one layer with overlap to secure the end wire of WDG1.
WDG2: Cancellation Winding	Start at pin 3. Wind 13 turns with trifilar of item 3 (#34AWG wire) from right to left with tight tension. Wind uniformly in a single layer across entire width of bobbin. Finish on pin 4.
Basic Insulation	1 layer of tape (Item 6) for insulation.



WDG3: Primary winding 3 layers.	Start at pin 4. Wind 132 turns of item 4 (#36AWG) from right to left in three layers across entire width of bobbin. Wind uniformly all layers with tight tension. Finish on pin 1.
Outer Insulation	7 Layer of tape using item 7.
Core Assembly	Assemble and secure core halves with glue.
Shield / Belly Band	Place outside 1 turn of item 8 with tight contact to winding surface. Connect item 8 to pin 3 by item 3.
Crop unused pins	Remove pin 7 and 8
Varnish	NO

7.5 Materials

Item	Description
[1]	Core: EF12.6
[2]	Bobbin: BEF12.6- Horizontal 8-PINS
[3]	Magnet Wire: #34 AWG
[4]	Magnet Wire: #36 AWG
[5]	Triple Insulated wire: # 32 AWG
[6]	Tape: 3M 1298 Polyester Film (white) 0.311 x 2 mils
[7]	Tape: 3M 1298 Polyester Film (white) 0.275 x 2 mils
[8]	Copper Foil: 0.01mils x 6mm

7.6 Design Notes

Power Integrations Device	LNK501P
Frequency of Operation	42KHZ
Mode	Discontinuous
Peak current	0.263 A
Reflected Voltage (Secondary to Primary)	47 V
AC Input Voltage Range	90-265VAC



8 Performance Data

All measurements performed at room temperature, 60 Hz input frequency.

8.1 Efficiency

The efficiency was measured at maximum output power at room temperature.

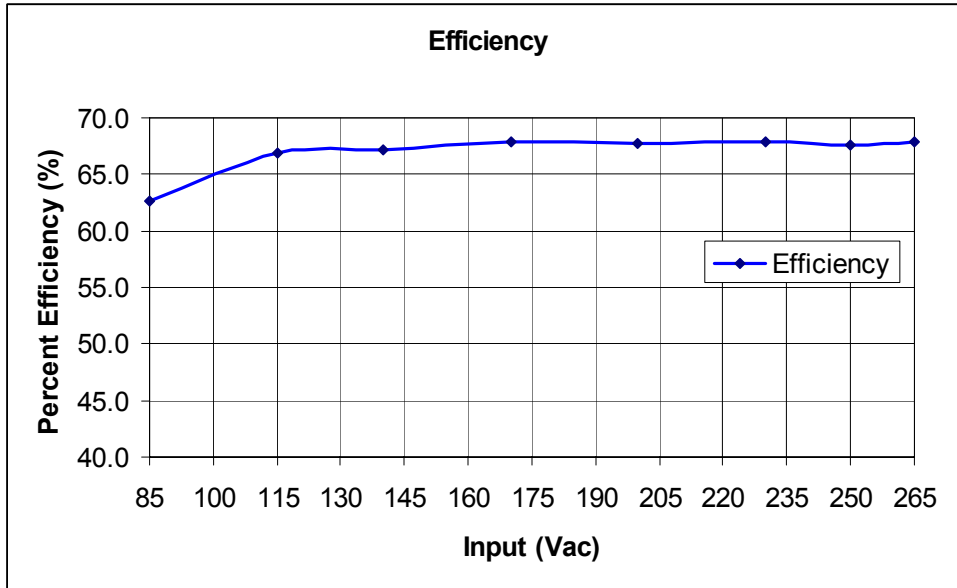

Figure 7 – Efficiency vs. Input voltage. At nominal inputs the efficiency is 67%



8.2 No-load Input Power

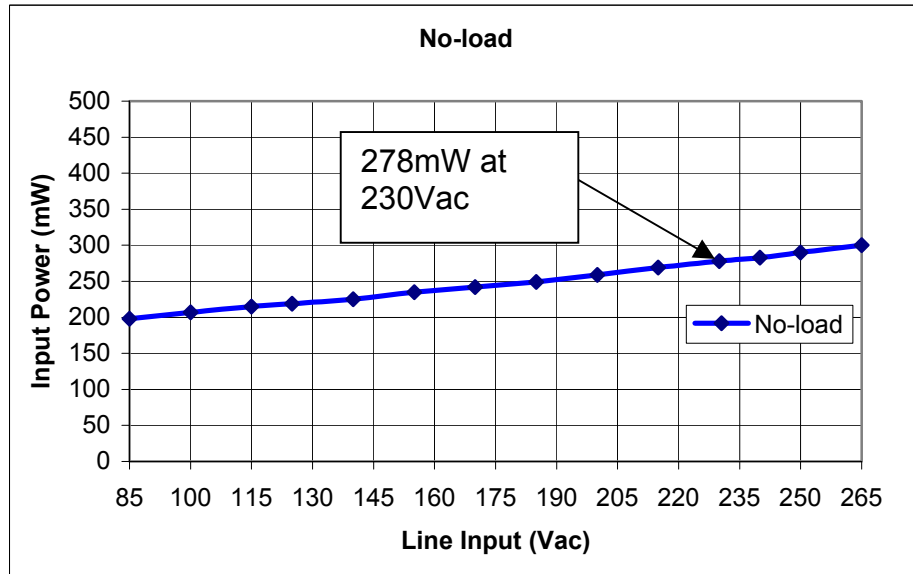

Figure 8 – Zero load input power vs. Input line voltage. The No-Load consumption at 230Vac is 278mW.

8.3 Line and Load Regulation

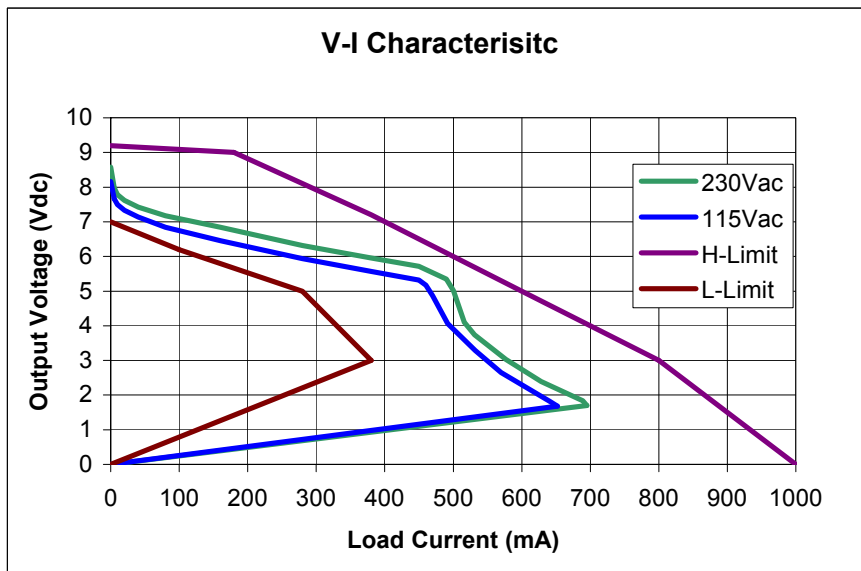

Figure 9 – Output VI Characteristic at selected input voltages (115V & 230V)



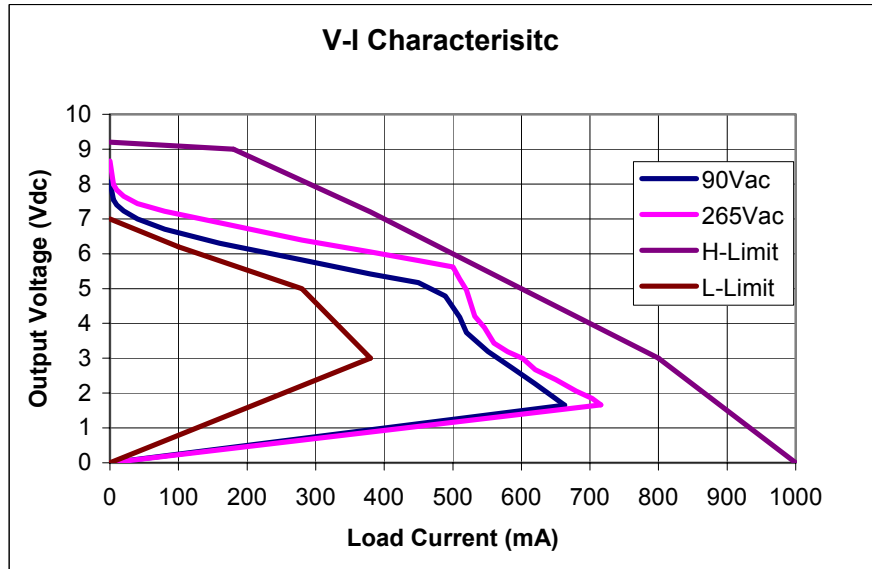

Figure 10 – Output VI Characteristic at selected input voltages (90V & 265V)



9 Thermal Performance

Measurement was taken at maximum output power inside a plastic enclosure at 90Vac;
 $T_{\text{AMBIENT}} = 25^{\circ}\text{C}$ with no airflow.

Reference	Description	Temperature
U1	LNK520P	67°C
T1	EF12.6 Transformer	54°C
D6	UG1B	69°C



10 Waveforms

10.1 Drain Voltage and Current, Normal Operation

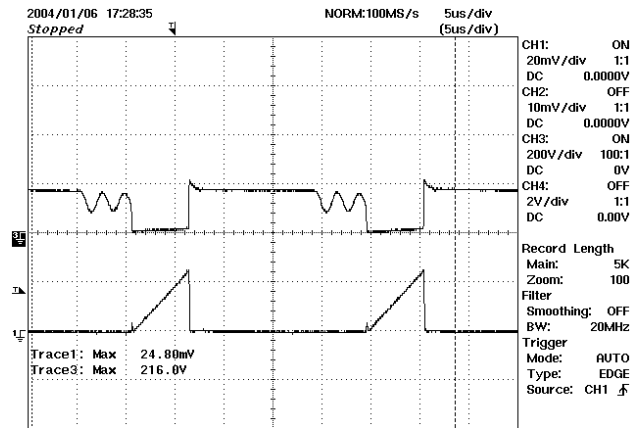

Figure 11 - 90 VAC, Full Load.

Upper: V_{DRAIN} , 200 V, 5 μ s / div
Lower: I_{DRAIN} , 0.2 A / div

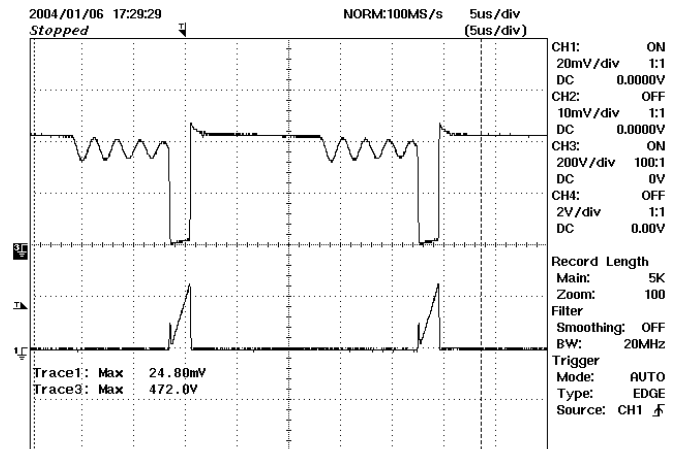

Figure 12 - 265 VAC, Full Load

Upper: V_{DRAIN} , 200 V, 5 μ s / div
Lower: I_{DRAIN} , 0.2 A / div



10.2 Output Ripple Measurements

10.2.1 Ripple Measurement Technique

For DC output ripple measurements, a modified oscilloscope test probe must be utilized in order to reduce spurious signals due to pickup. Details of the probe modification are provided in Figure 13 and Figure 14.

The 5125BA probe adapter is affixed with two capacitors tied in parallel across the probe tip. The capacitors include one (1) 0.1 $\mu\text{F}/50\text{ V}$ ceramic type and one (1) 1.0 $\mu\text{F}/50\text{ V}$ aluminum electrolytic. **The aluminum electrolytic type capacitor is polarized, so proper polarity across DC outputs must be maintained (see below).**

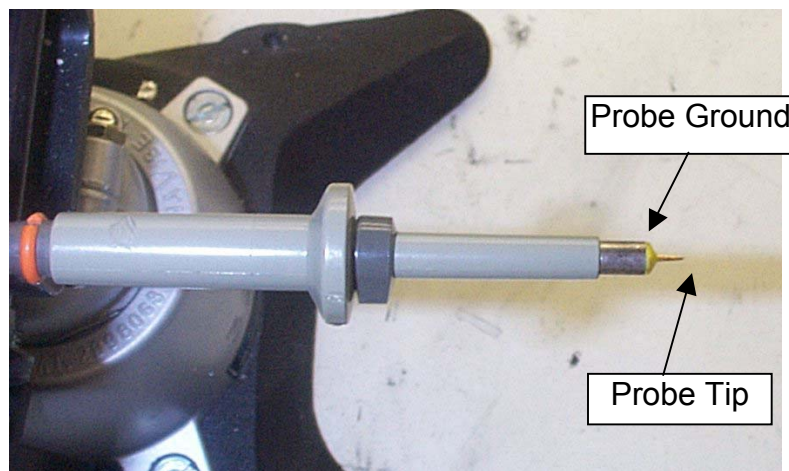

Figure 13 - Oscilloscope Probe Prepared for Ripple Measurement. (End Cap and Ground Lead Removed)



Figure 14 - Oscilloscope Probe with Probe Master 5125BA BNC Adapter. (Modified with wires for probe ground for ripple measurement, and two parallel decoupling capacitors added)

10.2.2 Measurement Results

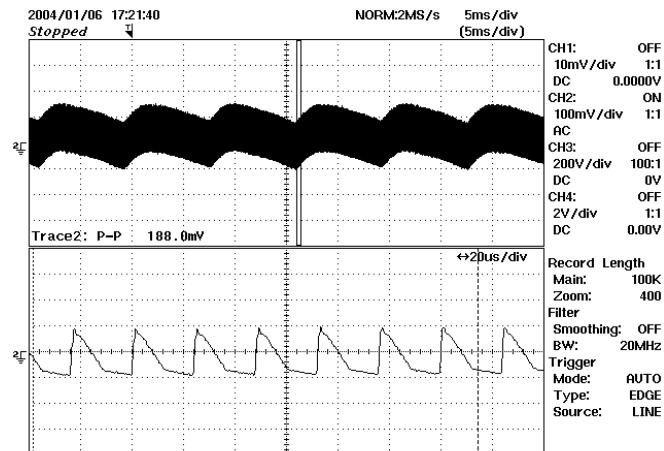

Figure 15 – V Ripple, 90 VAC, Full Load.
5 ms, 100 mV / div

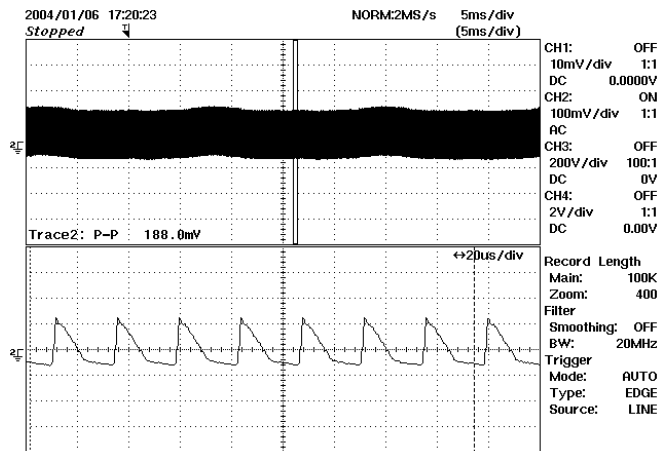

Figure 16 - V Ripple, 115 VAC, Full Load.
2 ms, 50 mV / div

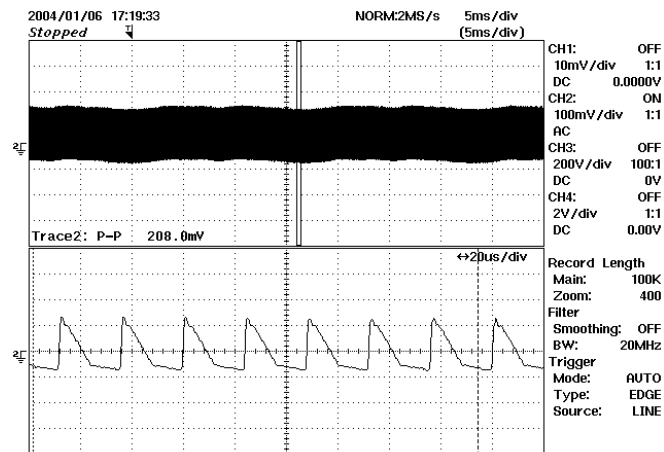

Figure 17 - Ripple, 230 VAC, Full Load.
5 ms, 100 mV /div

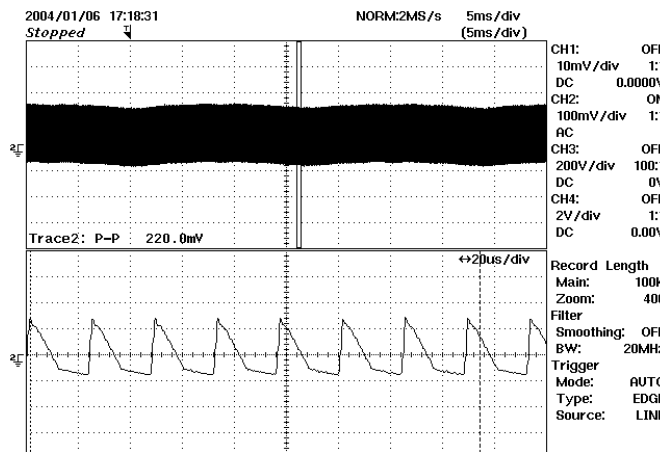

Figure 18 - Ripple, 265 VAC, Full Load.
5 ms, 100 mV /div



11 Conducted EMI

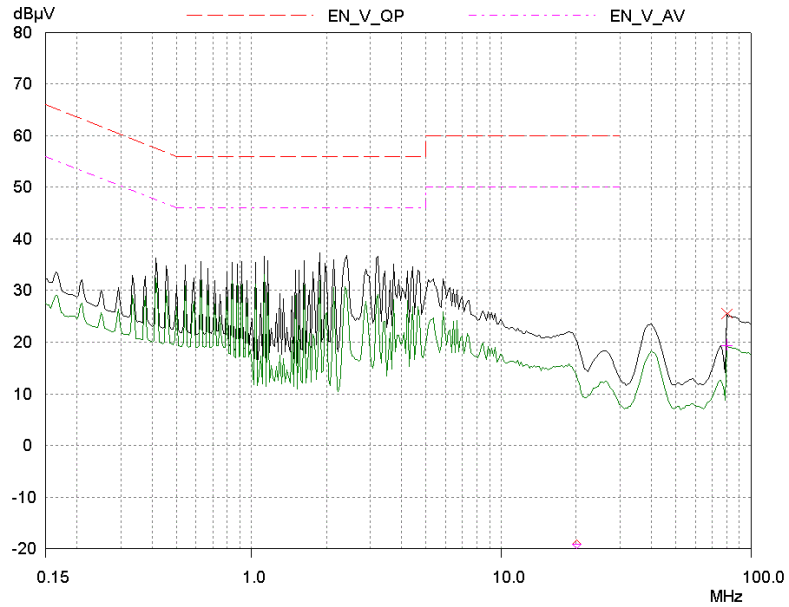

Figure 19 - Conducted EMI, Maximum Steady State Load, LINE 115 VAC, 60 Hz, and EN55022 B Limits. **With** Artificial hand connected to Sec GND.

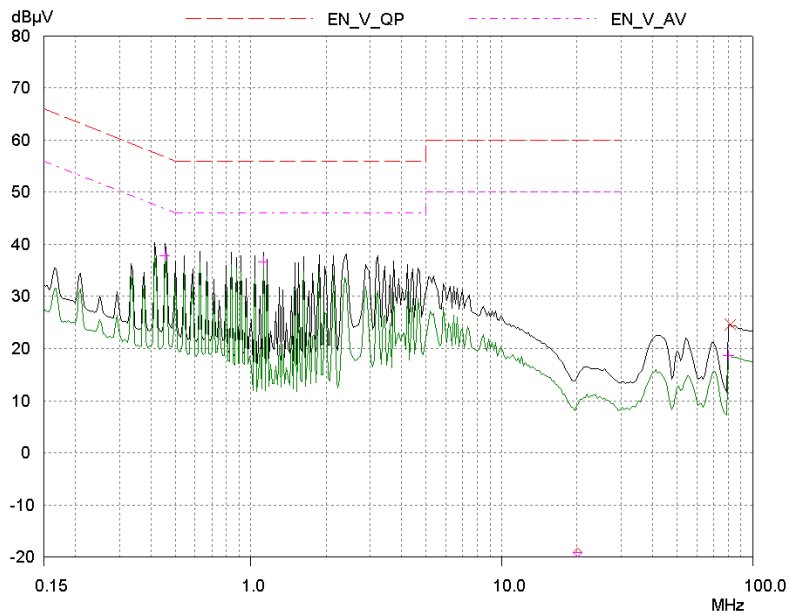

Figure 20 - Conducted EMI, Maximum Steady State Load, LINE 115 VAC, 60 Hz, and EN55022 B Limits. **Without** Artificial hand connected to Sec GND.



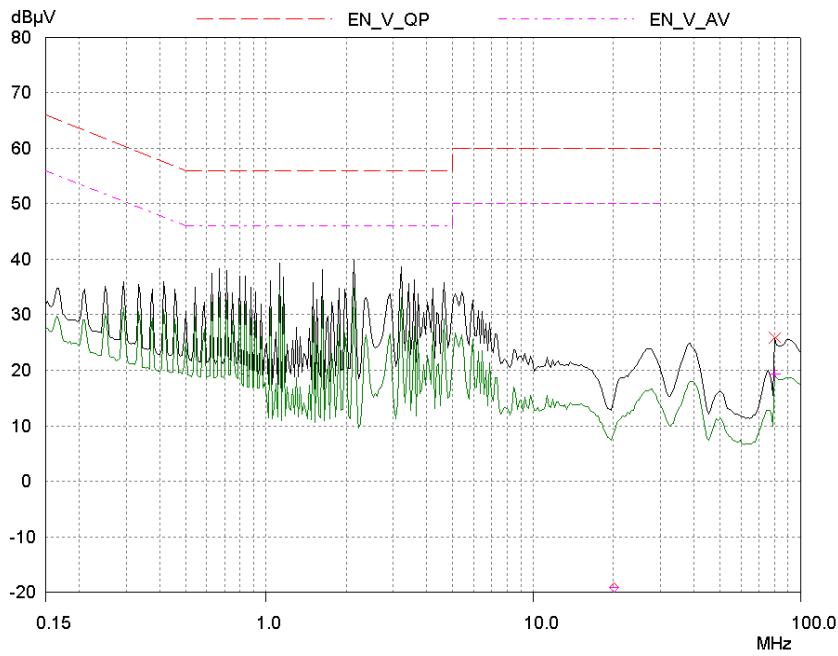

Figure 21 - Conducted EMI, Maximum Steady State Load, LINE 230 VAC, 60 Hz, and EN55022 B Limits. With Artificial hand connected to Sec GND.

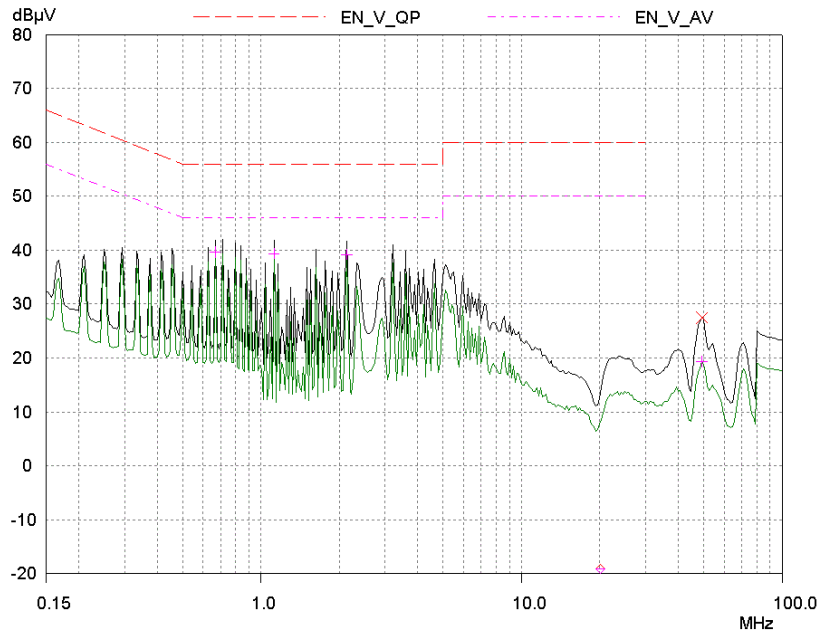

Figure 22 - Conducted EMI, Maximum Steady State Load, LINE 230 VAC, 60 Hz, and EN55022 B Limits. Without Artificial hand connected to Sec GND.



12 Revision History

Date	Author	Revision	Description & changes	Reviewed
May 13, 2004	ME	1.0	First Release	VC / AM

For the latest updates, visit our Web site: www.powerint.com

PATENT INFORMATION

Power Integrations reserves the right to make changes to its products at any time to improve reliability or manufacturability. Power Integrations does not assume any liability arising from the use of any device or circuit described herein, nor does it convey any license under its patent rights or the rights of others.

The products and applications illustrated herein (including circuits external to the products and transformer construction) may be covered by one or more U.S. and foreign patents or potentially by pending U.S. and foreign patent applications assigned to Power Integrations. A complete list of Power Integrations' patents may be found at www.powerint.com.

The PI Logo, **TOPSwitch**, **TinySwitch**, **LinkSwitch**, and **EcoSmart** are registered trademarks of Power Integrations, Inc. **PI Expert** and **DPA-Switch** are trademarks of Power Integrations, Inc.
© Copyright 2003, Power Integrations, Inc.

WORLD HEADQUARTERS

NORTH AMERICA - WEST

Power Integrations, Inc.
5245 Hellyer Avenue
San Jose, CA 95138 USA.
Main: +1-408-414-9200
Customer Service:
Phone: +1-408-414-9665
Fax: +1-408-414-9765
e-mail:
usasales@powerint.com

CHINA

Power Integrations
International Holdings, Inc.
Rm# 1705, Bao Hua Bldg.
1016 Hua Qiang Bei Lu
Shenzhen Guangdong,
518031
Phone: +86-755-8367-5143
Fax: +86-755-8377-9610
e-mail:
chinasales@powerint.com

APPLICATIONS HOTLINE

World Wide +1-408-414-9660

EUROPE & AFRICA

Power Integrations (Europe) Ltd.
Centennial Court
Easthampstead Road
Bracknell
Berkshire RG12 1YQ,
United Kingdom
Phone: +44-1344-462-300
Fax: +44-1344-311-732
e-mail: eurosales@powerint.com

KOREA

Power Integrations
International Holdings, Inc.
Rm# 402, Handuk Building,
649-4 Yeoksam-Dong,
Kangnam-Gu,
Seoul, Korea
Phone: +82-2-568-7520
Fax: +82-2-568-7474
e-mail: koreasales@powerint.com

APPLICATIONS FAX

World Wide +1-408-414-9760

SINGAPORE

Power Integrations, Singapore
51 Goldhill Plaza #16-05
Republic of Singapore,
308900
Phone: +65-6358-2160
Fax: +65-6358-2015
e-mail:
singaporesales@powerint.com

JAPAN

Power Integrations, K.K.
Keihin-Tatemono 1st Bldg.
12-20 Shin-Yokohama
2-Chome,
Kohoku-ku, Yokohama-shi,
Kanagawa 222-0033, Japan
Phone: +81-45-471-1021
Fax: +81-45-471-3717
e-mail:
japansales@powerint.com

TAIWAN

Power Integrations
International Holdings, Inc.
17F-3, No. 510
Chung Hsiao E. Rd.,
Sec. 5,
Taipei, Taiwan 110, R.O.C.
Phone: +886-2-2727-1221
Fax: +886-2-2727-1223
e-mail:
taiwansales@powerint.com

INDIA (Technical Support)

Innovatech
#1, 8th Main Road
Vasanthnagar
Bangalore, India 560052
Phone: +91-80-226-6023
Fax: +91-80-228-9727
e-mail:
indiasales@powerint.com

