

DomiLED – AlInGaP : DDx-xRS

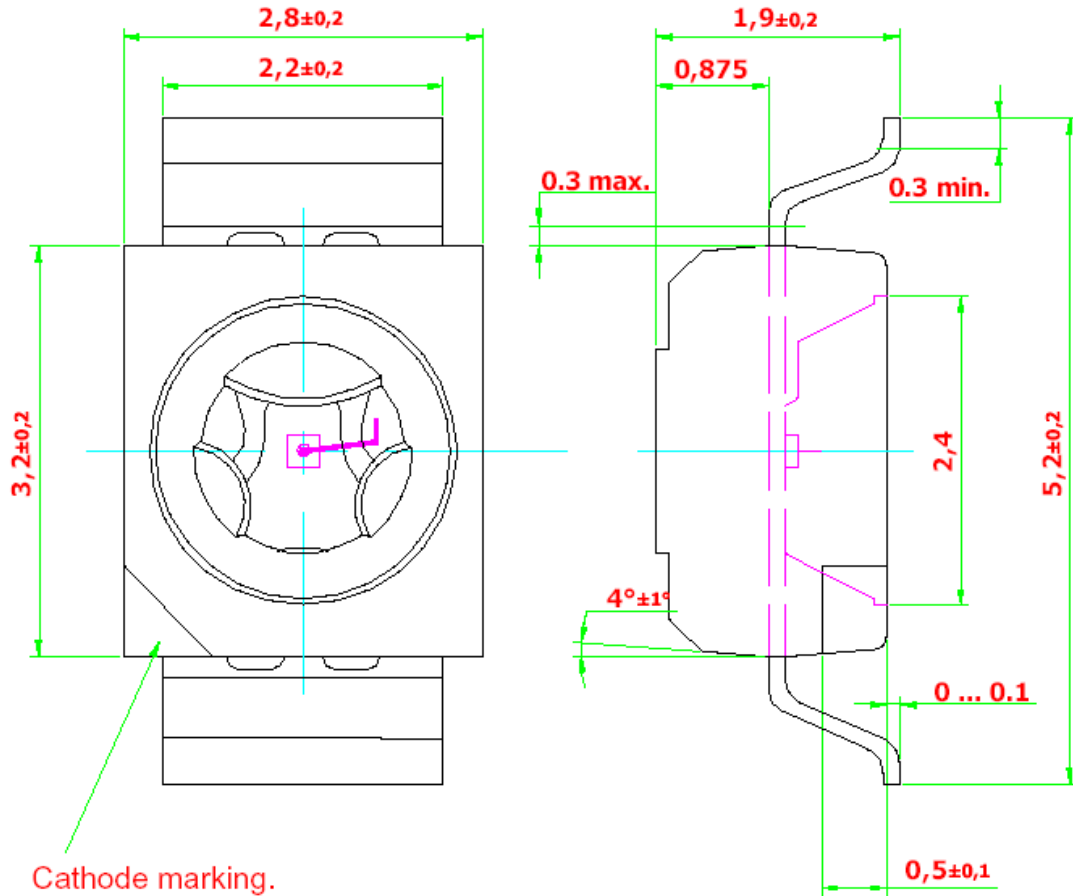

- High brightness surface mount LED.
- 120° viewing angle.
- Small package outline (LxWxH) of 2.8 x 3.2 x 1.8 mm.
- Qualified according to JEDEC moisture sensitivity Level 2.
- Compatible to both IR reflow soldering and TTW soldering.

Part Ordering Number	Chip Technology / Color	Viewing Angle °	Luminous Intensity @ IF=20mA Iv (mcd)
DDH-CRS-PQ2-1 <ul style="list-style-type: none"> • DDH-CRS-P1 • DDH-CRS-P2 • DDH-CRS-Q1 • DDH-CRS-Q2 DDH-SRS-QR2-1 <ul style="list-style-type: none"> • DDH-SRS-Q1 • DDH-SRS-Q2 • DDH-SRS-R1 • DDH-SRS-R2 	AllnGaP Hyper-red, 640nm	120	45.0 – 112.5 45.0 – 56.0 56.0 – 71.5 71.5 – 90.0 90.0 – 112.5 71.5 – 180.0 71.5 – 90.0 90.0 – 112.5 112.5 – 140.0 140.0 – 180.0
DDS-CRS-PQ2-1 <ul style="list-style-type: none"> • DDS-CRS-P1 • DDS-CRS-P2 • DDS-CRS-Q1 • DDS-CRS-Q2 <i>** Not for new design.</i> DDS-CRS-QR2-1 <ul style="list-style-type: none"> • DDS-CRS-Q1 • DDS-CRS-Q2 • DDS-CRS-R1 • DDS-CRS-R2 DDS-SRS-QR2-1 <ul style="list-style-type: none"> • DDS-SRS-Q1 • DDS-SRS-Q2 • DDS-SRS-R1 • DDS-SRS-R2 	AllnGaP Super-red, 632nm	120	45.0 – 112.5 45.0 – 56.0 56.0 – 71.5 71.5 – 90.0 90.0 – 112.5 71.5 – 180.0 71.5 – 90.0 90.0 – 112.5 112.5 – 140.0 140.0 – 180.0 71.5 – 180.0 71.5 – 90.0 90.0 – 112.5 112.5 – 140.0 140.0 – 180.0
DDR-CRS-QR2-1 <ul style="list-style-type: none"> • DDR-CRS-Q1 • DDR-CRS-Q2 • DDR-CRS-R1 • DDR-CRS-R2 <i>** Not for new design.</i> DDR-CRS-RS2-1 <ul style="list-style-type: none"> • DDR-CRS-R1 • DDR-CRS-R2 • DDR-CRS-S1 • DDR-CRS-S2 DDR-SRS-RS2-1 <ul style="list-style-type: none"> • DDR-SRS-R1 • DDR-SRS-R2 • DDR-SRS-S1 • DDR-SRS-S2 	AllnGaP Red, 625nm	120	71.5 – 180.0 71.5 – 90.0 90.0 – 112.5 112.5 – 140.0 140.0 – 180.0 112.5 – 285.0 112.5 – 140.0 140.0 – 180.0 180.0 – 224.0 224.0 – 285.0 112.5 – 285.0 112.5 – 140.0 140.0 – 180.0 180.0 – 224.0 224.0 – 285.0

Part Ordering Number	Chip Technology / Color	Viewing Angle	Luminous Intensity @ IF=20mA Iv (mcd)
DDR-TRS-TU2-1 <ul style="list-style-type: none"> • DDR-TRS-T1 • DDR-TRS-T2 • DDR-TRS-U1 • DDR-TRS-U2 	Ts AlInGaP Red, 625nm	120	285.0 – 715.0 285.0 – 355.0 355.0 – 450.0 450.0 – 560.0 560.0 – 715.0
DDA-CRS-RS2-1 <ul style="list-style-type: none"> • DDA-CRS-R1 • DDA-CRS-R2 • DDA-CRS-S1 • DDA-CRS-S2 DDA-SRS-ST2-1 <ul style="list-style-type: none"> • DDA-SJS-S1 • DDA-SJS-S2 • DDA-SJS-T1 • DDA-SJS-T2 	As AlInGaP Amber, 615nm	120	112.5 – 285.0 112.5 – 140.0 140.0 – 180.0 180.0 – 224.0 224.0 – 285.0 180.0 – 450.0 180.0 – 224.0 224.0 – 285.0 285.0 – 355.0 355.0 – 450.0
DDO-CRS-RS2-1 <ul style="list-style-type: none"> • DDO-CRS-R1 • DDO-CRS-R2 • DDO-CRS-S1 • DDO-CRS-S2 DDO-SRS-ST2-1 <ul style="list-style-type: none"> • DDO-SRS-S1 • DDO-SRS-S2 • DDO-SRS-T1 • DDO-SRS-T2 	As AlInGaP Orange, 605nm	120	112.5 – 285.0 112.5 – 140.0 140.0 – 180.0 180.0 – 224.0 224.0 – 285.0 180.0 – 450.0 180.0 – 224.0 224.0 – 285.0 285.0 – 355.0 355.0 – 450.0
DDY-CRS-QR2-1 <ul style="list-style-type: none"> • DDY-CRS-Q1 • DDY-CRS-Q2 • DDY-CRS-R1 • DDY-CRS-R2 ** Not for new design	As AlInGaP Yellow, 587nm	120	71.5 – 180.0 71.5 – 90.0 90.0 – 112.5 112.5 – 140.0 140.0 – 180.0
DDY-CRS-RS2-1 <ul style="list-style-type: none"> • DDY-CRS-R1 • DDY-CRS-R2 • DDY-CRS-S1 • DDY-CRS-S2 DDY-SRS-ST2-1 <ul style="list-style-type: none"> • DDY-SRS-S1 • DDY-SRS-S2 • DDY-SRS-T1 • DDY-SRS-T2 			112.5 – 285.0 112.5 – 140.0 140.0 – 180.0 180.0 – 224.0 224.0 – 285.0 180.0 – 450.0 180.0 – 224.0 224.0 – 285.0 285.0 – 355.0 355.0 – 450.0

Part Ordering Number	Chip Technology / Color	Viewing Angle	Luminous Intensity @ IF=20mA Iv (mcd)
DDY-TRS-TU2-1 <ul style="list-style-type: none"> • DDY-TRS-T1 • DDY-TRS-T2 • DDY-TRS-U1 • DDY-TRS-U2 	Ts AlInGaP Yellow, 590nm	120	285.0 – 715.0 285.0 – 355.0 355.0 – 450.0 450.0 – 560.0 560.0 – 715.0
DDG-CRS-PQ2-1 <ul style="list-style-type: none"> • DDG-CRS-P1 • DDG-CRS-P2 • DDG-CRS-Q1 • DDG-CRS-Q2 DDG-SRS-QR2-1 <ul style="list-style-type: none"> • DDG-SRS-Q1 • DDG-SRS-Q2 • DDG-SRS-R1 • DDG-SRS-R2 	As AlInGaP Green, 572nm	120	45.0 – 112.5 45.0 – 56.0 56.0 – 71.5 71.5 – 90.0 90.0 – 112.5 71.5 – 180.0 71.5 – 90.0 90.0 – 112.5 112.5 – 140.0 140.0 – 180.0

NOTE:

1. All part number above comes in a quantity of 2000 units per reel.
2. Other luminous intensity groups are also available upon request.
3. Luminous intensity is measured with an accuracy of $\pm 11\%$.
4. Wavelength binning is carried for all units as per the wavelength-binning table. Only one wavelength group is allowed for each reel.
5. An optional Vf binning is also available upon request. Binning scheme is as per following table.

Wavelength Grouping.

Color	Group	Wavelength distribution (nm)
DDH; Hyper-red	Full	636 - 646
DDS; Super-red	Full	625 – 640
DDR-CJ, -SJ; Red (AS)	Full	620 – 630
DDR-TJ; Red (TS)	Full	620 - 635
DDA; Amber	Full	610 – 621
	W	610 – 615
	X	615 – 621
DDO; Orange	Full	600 – 612
	W	600 – 603
	X	603 – 606
	Y	606 - 609
	Z	609 - 612
DDY; Yellow	Full	582 – 594
	W	582 – 585
	X	585 – 588
	Y	588 - 591
	Z	591 - 594
DDG; Green	Full	564.5 – 576.5
	W	564.5 – 567.5
	X	567.5 – 570.5
	Y	570.5 – 573.5
	Z	573.5 – 576.5

Dominant wavelength is measured with an accuracy of ± 1 nm.

Electrical Characteristics at Ta=25°C.

Part Number	Vf @ If = 20mA		Vr @ Ir = 100uA
	Typ. (V)	Max. (V)	Min.(V)
DDA, DDS, DDR-CJS, DDR-SJS, DDG	2.1	2.3	12
DDH, DDO, DDY-CJS, DDY-SJS			
DDR-TJS, DDY-TJS	2.2	2.6	12

Forward voltage, Vf is measured with an accuracy of ± 0.1 V.

Vf Binning.

Vf Bin @ 20mA	Forward Voltage (V)
01	1.55 ... 1.85
02	1.85 ... 2.15
03	2.15 ... 2.45
04	2.45 ... 2.75

Forward voltage, Vf is measured with an accuracy of ± 0.1 V

Absolute Maximum Ratings.

	Maximum Value	Unit
DC forward current.	30	mA
Peak pulse current; ($t_p \leq 10 \mu\text{s}$, Duty cycle = 0.005)	1000	mA
Reverse voltage.	5	V
LED junction temperature.	125	$^{\circ}\text{C}$
Operating temperature.	-40 ... +100	$^{\circ}\text{C}$
Storage temperature.	-40 ... +100	$^{\circ}\text{C}$
Power dissipation (at room temperature)	75	mW

Recommended Solder Pad

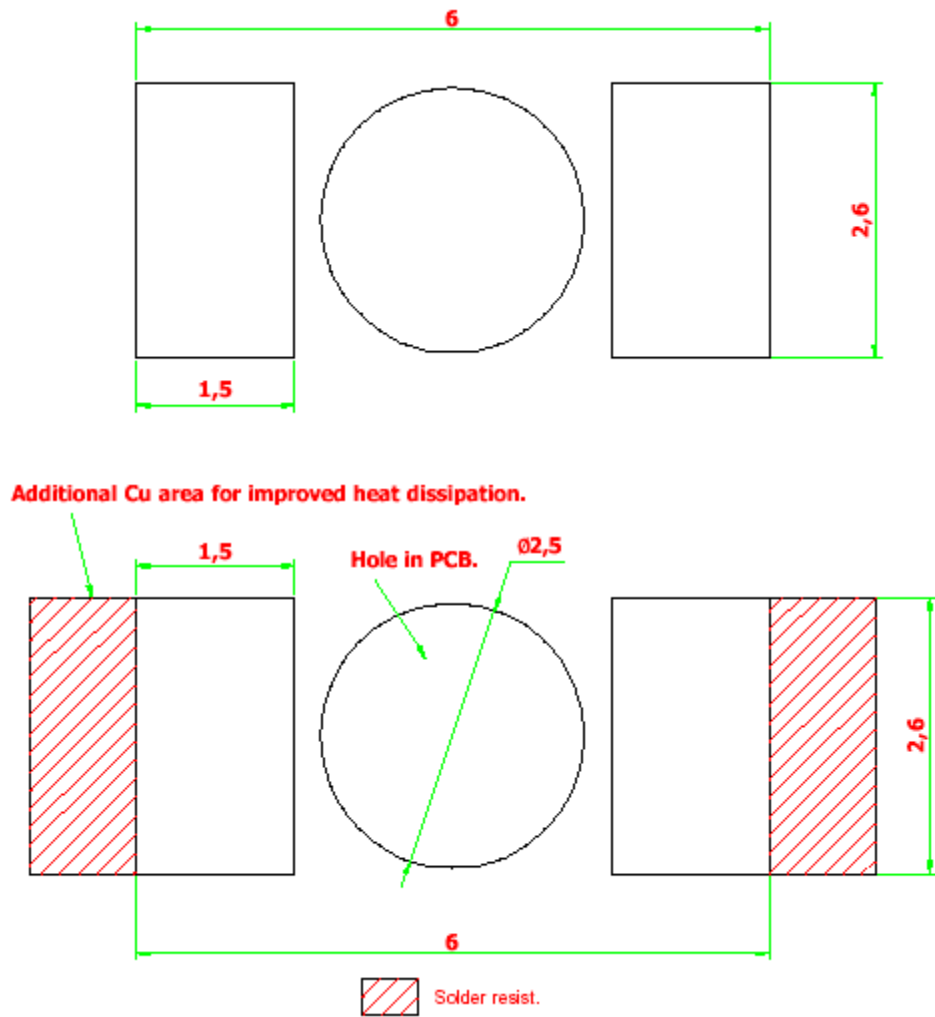

Relative intensity vs. forward current.

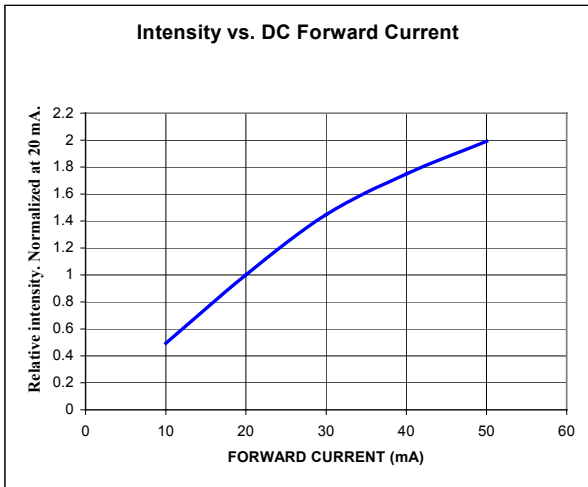

Forward current vs. forward voltage.

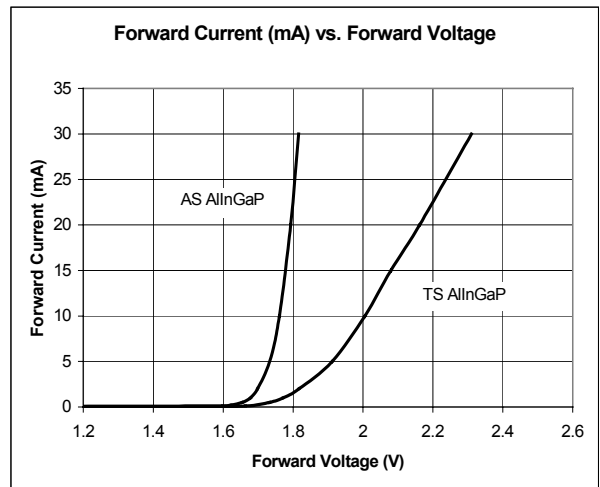

Radiation pattern.

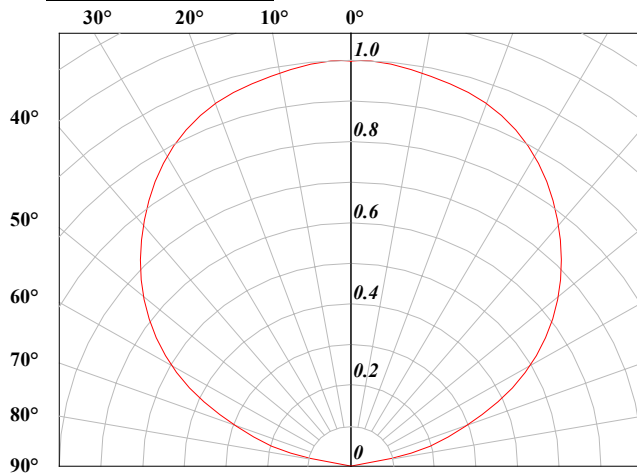

Maximum forward current vs. temperature.

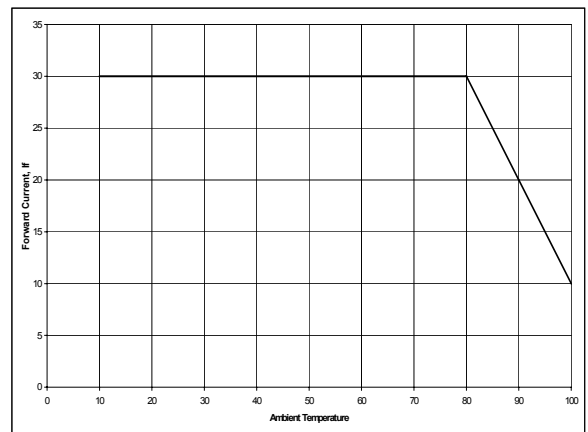

Relative Intensity vs. Wavelength

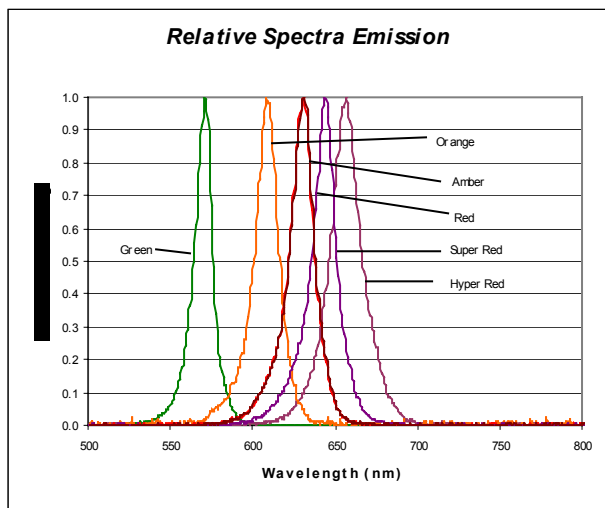

Taping And Orientation.

Reels come in quantity of 8000 units or 2000 units.

Reel diameters are 330 mm and 180 mm respectively.

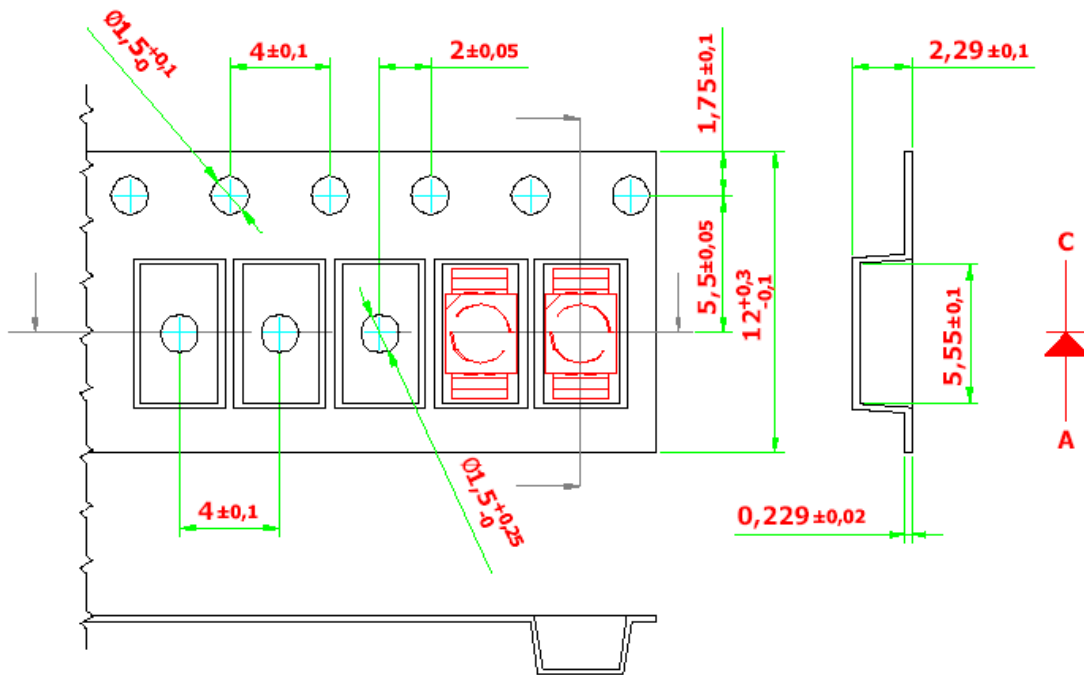

200 mm min. for Ø180 reel.
200 mm min. for Ø330 reel.

480 mm min. for Ø180 reel.
960 mm min. for Ø330 reel.

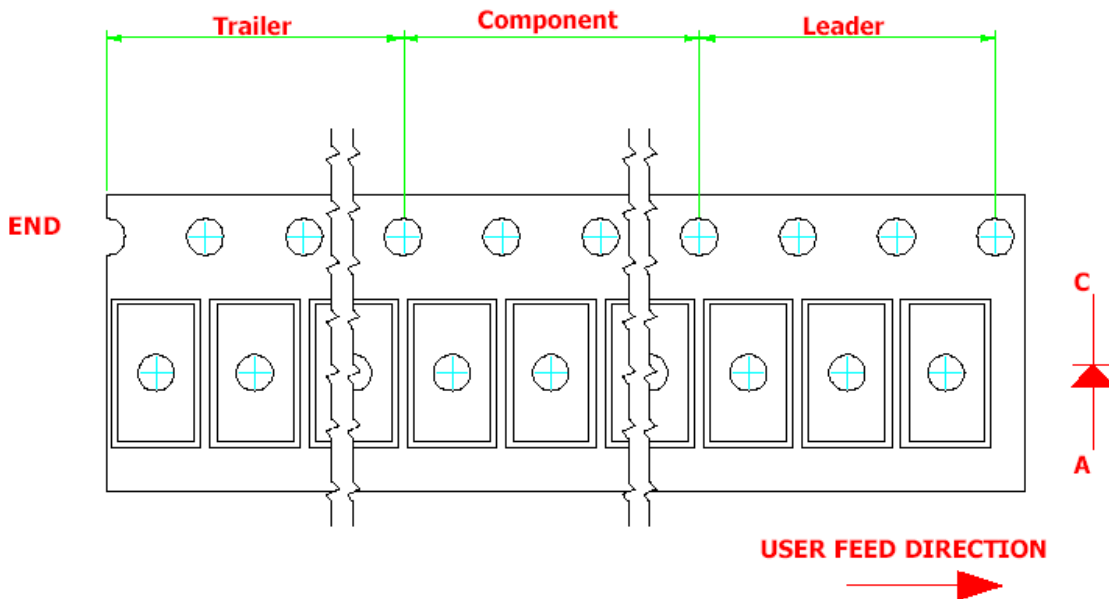

Recommended Sn-Pb IR-Reflow Soldering Profile.

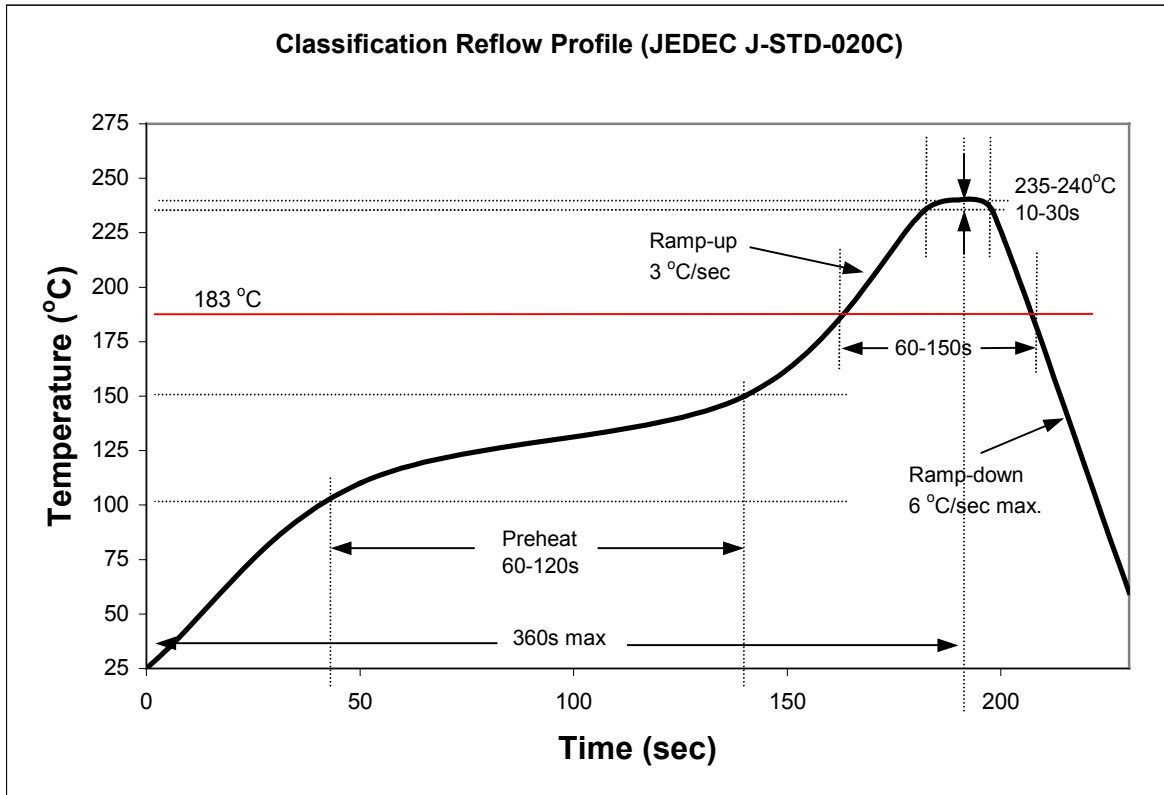

Recommended Pb Free IR-Reflow Soldering Profile.

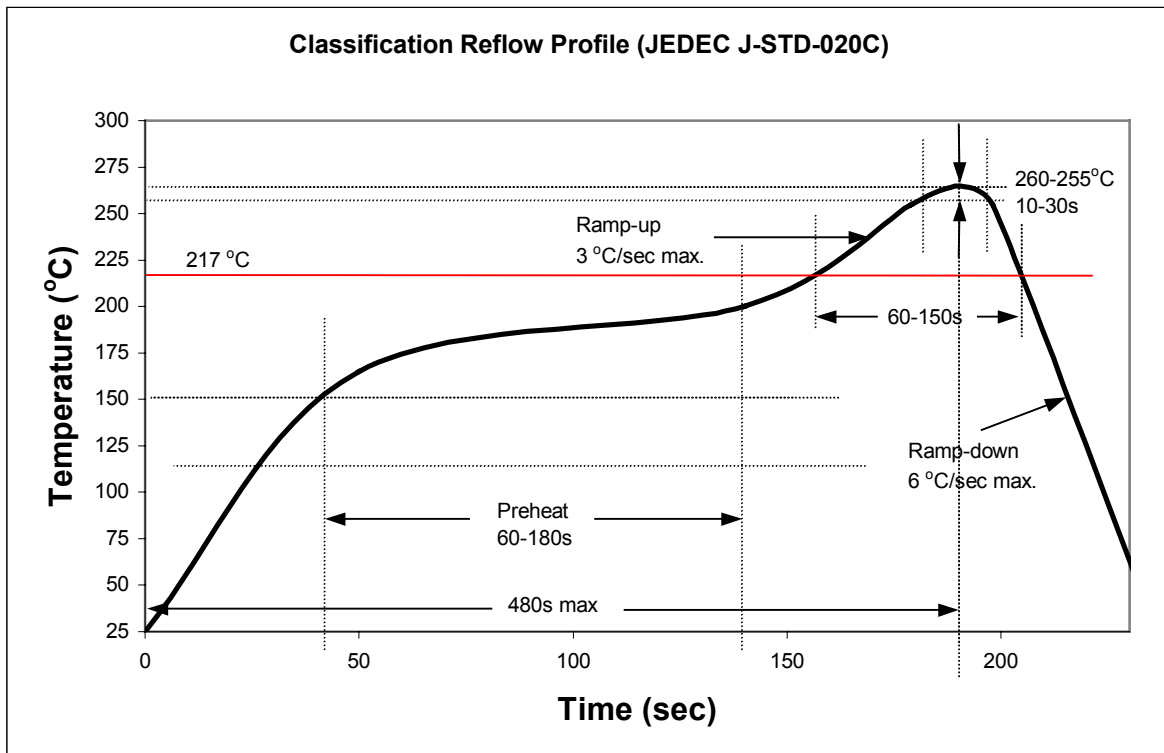

NOTE.

All the information published is considered to be reliable. However, DOMINANT Semiconductors does not assume any liability arising out of the application or use of any product described herein.

DOMINANT Semiconductors reserves the right to make changes at any time without notice to any products in order to improve reliability, function or design.

DOMINANT Semiconductors products are not authorized for use as critical components in life support devices or systems without the express written approval from the managing director of DOMINANT Semiconductors.