

Domiled[™]

Synonymous with function and performance, the Domiled[™] series is perfectly suited for a variety of cross-industrial applications due to its small package outline, durability and superior brightness.



Features:

- > High brightness surface mount LED.
- > Based on InGaN on patented SiC technology.
- > 120° viewing angle.
- > Small package outline (LxWxH) of 3.2 x 2.8 x 1.8mm.
- > Qualified according to JEDEC moisture sensitivity Level 2.
- > Compatible to both IR reflow soldering and TTW soldering.



Applications:

- > Automotive: interior applications, eg: switches, telematics, climate control system, dashboard, etc.
- > Consumer Appliances: LCD illumination as in PDAs, LCD TV.
- > Communication: indicator and backlight in mobilephone.
- > Display: full color display video notice board.
- > Industry: white goods (eg: Oven, microwave, etc.).



Part Ordering Number	Chip Technology / Color	Viewing Angle°	Luminous Intensity @ IF = 30mA IV (mcd)
DDP-SJS-NP2-1-I3	AllnGaP/	120	28.5 - 71.5
• DDP-SJS-N1	Pure Green, 560nm		28.5 - 35.5
• DDP-SJS-N2			35.5 - 45.0
• DDP-SJS-P1			45.0 - 56.0
• DDP-SJS-P2			56.0 - 71.5

NOTE

1. All part number above comes in a quantity of 2000 units per reel.
2. Luminous intensity is measured with an accuracy of ± 11%.
3. Wavelength binning is carried for all units as per the wavelength-binning table. Only one wavelength group is allowed for each reel.

Electrical Characteristics at Ta=25°C

Part Number	Vf @ If = 30mA		Vr @ Ir = 10uA
	Typ. (V)	Max. (V)	Min. (V)
DDP-SJS	1.9	2.4	12

Forward voltage are measured using a current pulse of 1 ms and with an accuracy of ± 0.1 V.

Wavelength Grouping.

Color	Group	Wavelength distribution(nm)
DDP; Pure Green	Full	552.5 - 564.5
	W	552.5 - 555.5
	X	555.5 - 558.5
	Y	558.5 - 561.5
	Z	561.5 - 564.5

Dominant wavelength is measured with an accuracy of ± 1 nm.

Absolute Maximum Ratings

	Maximum Value	Unit
DC forward current	50	mA
Peak pulse current; (tp ≤ 10μs, Duty cycle = 0.005)	1000	mA
Reverse voltage	12	V
ESD Threshold (HBM)	2000	V
LED junction temperature	125	°C
Operating temperature	-40 ... +100	°C
Storage temperature	-40 ... +100	°C
Power dissipation (at room temperature)	120	mW

Relative Luminous Intensity Vs Forward Current

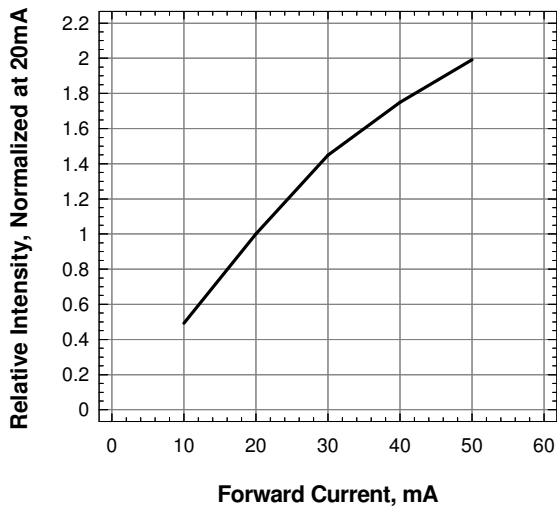

Forward Current Vs Forward Voltage

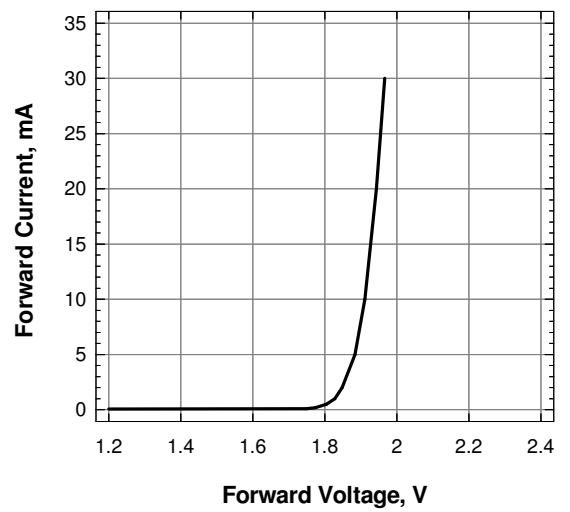

Maximum Current Vs Temperature

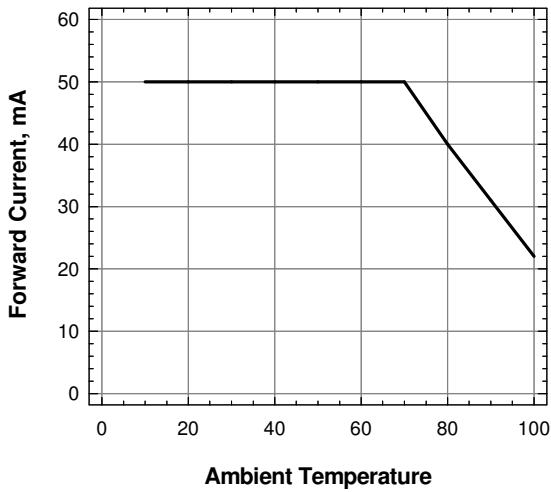

Relative Intensity Vs Wavelength

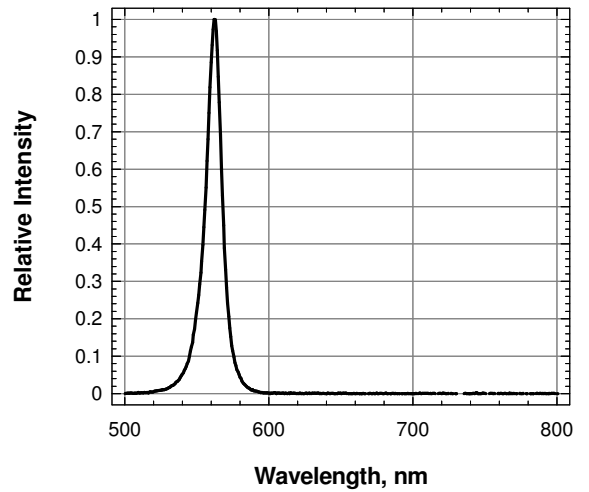

Radiation Pattern

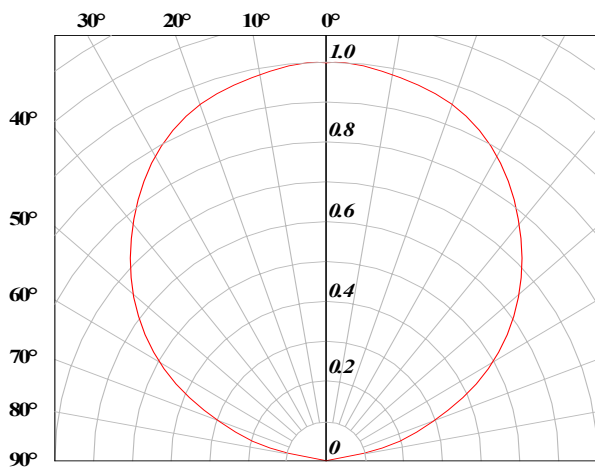

DomiLED™ • AllnGaP : DDP-SJS-NP2-1-I3 Package Outlines

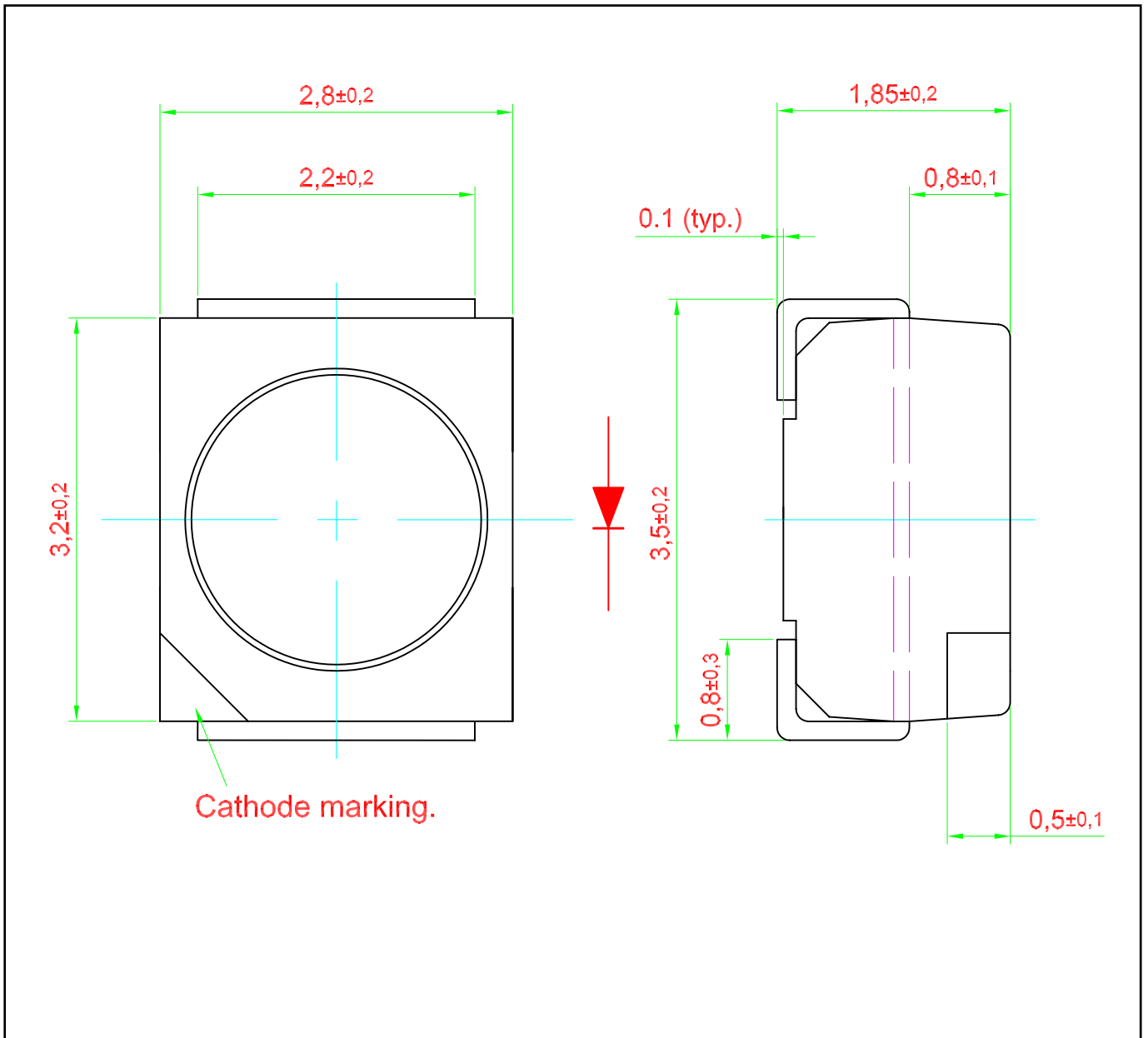

Recommended Solder Pad

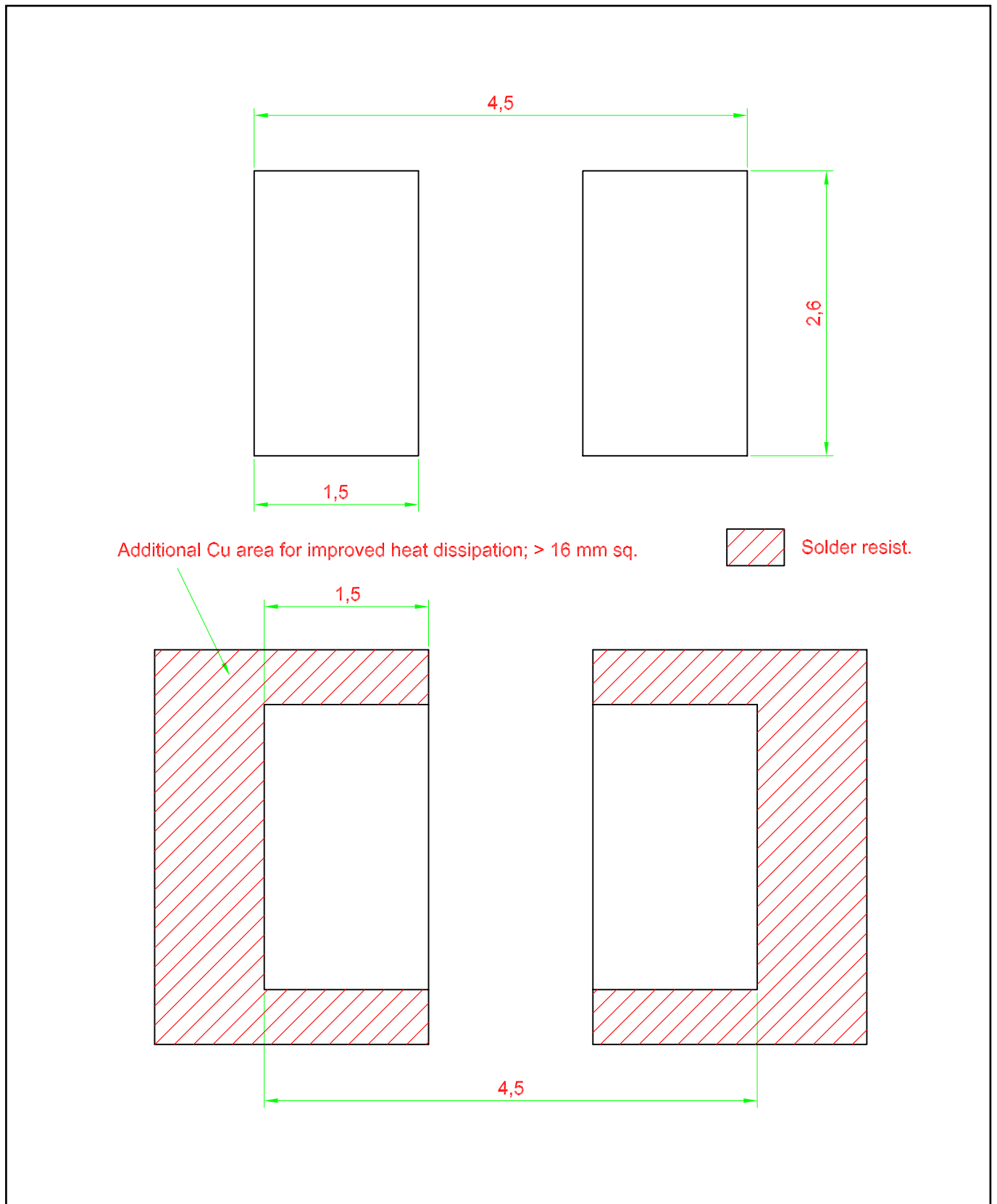

Taping and orientation

- Reels come in quantity of 2000 units.
- Reel diameter is 180 mm.

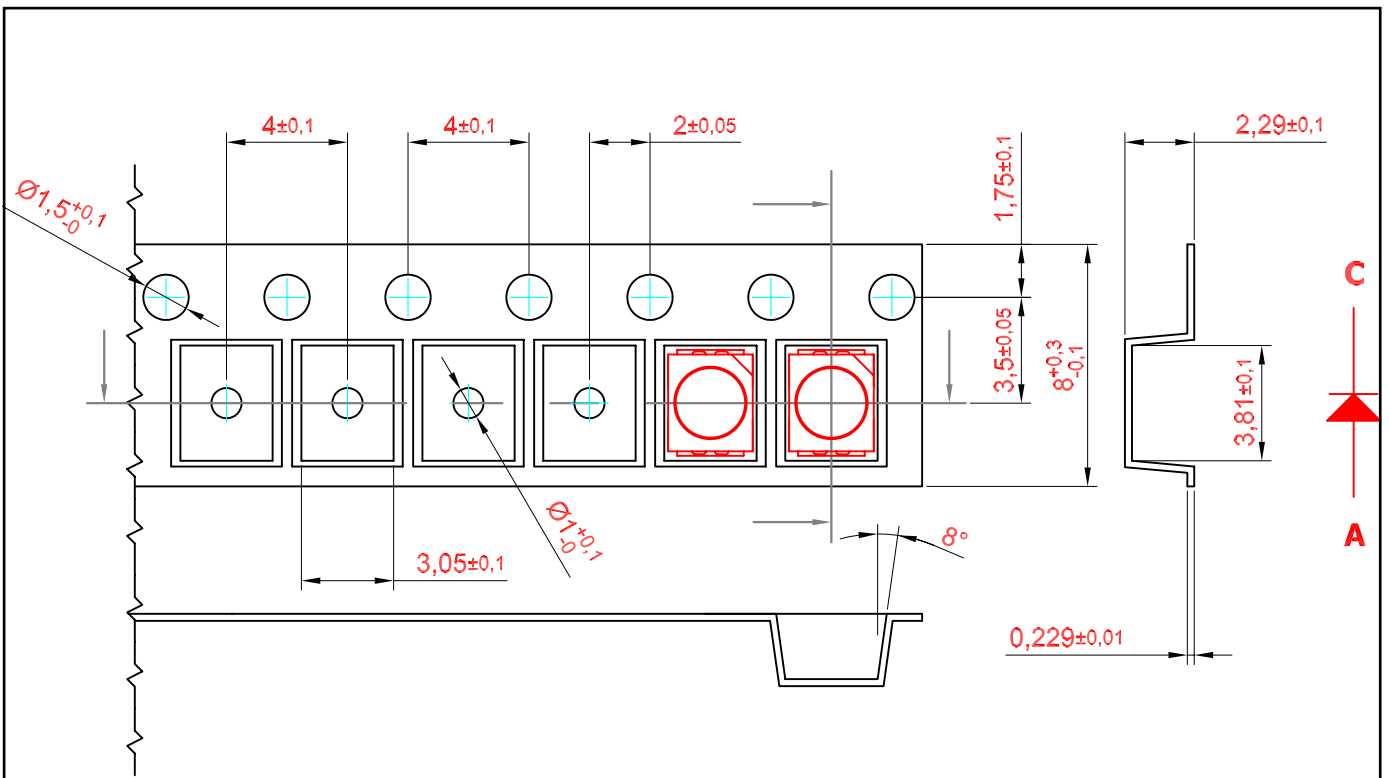

200 mm min. for $\varnothing 180$ reel.
200 mm min. for $\varnothing 330$ reel.

480 mm min. for $\varnothing 180$ reel.
960 mm min. for $\varnothing 330$ reel.

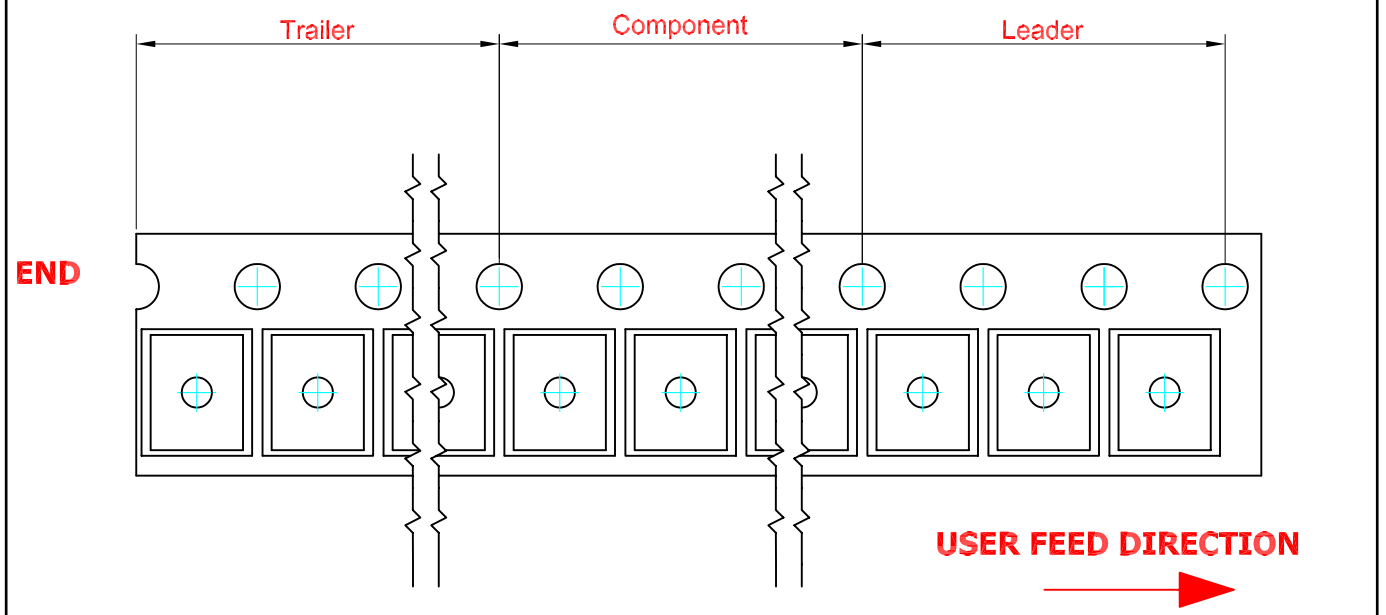

Packaging Specification

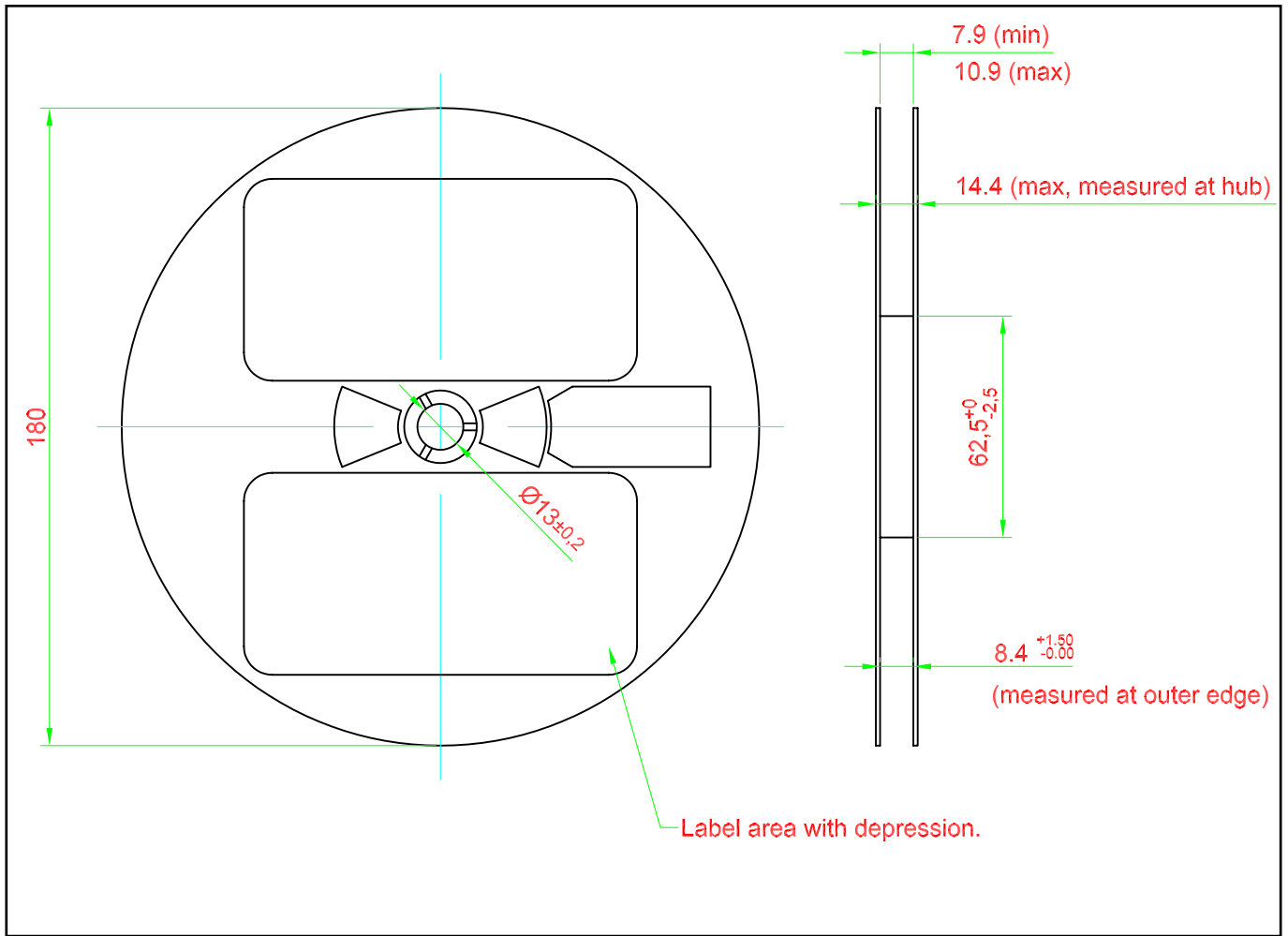

Packaging Specification

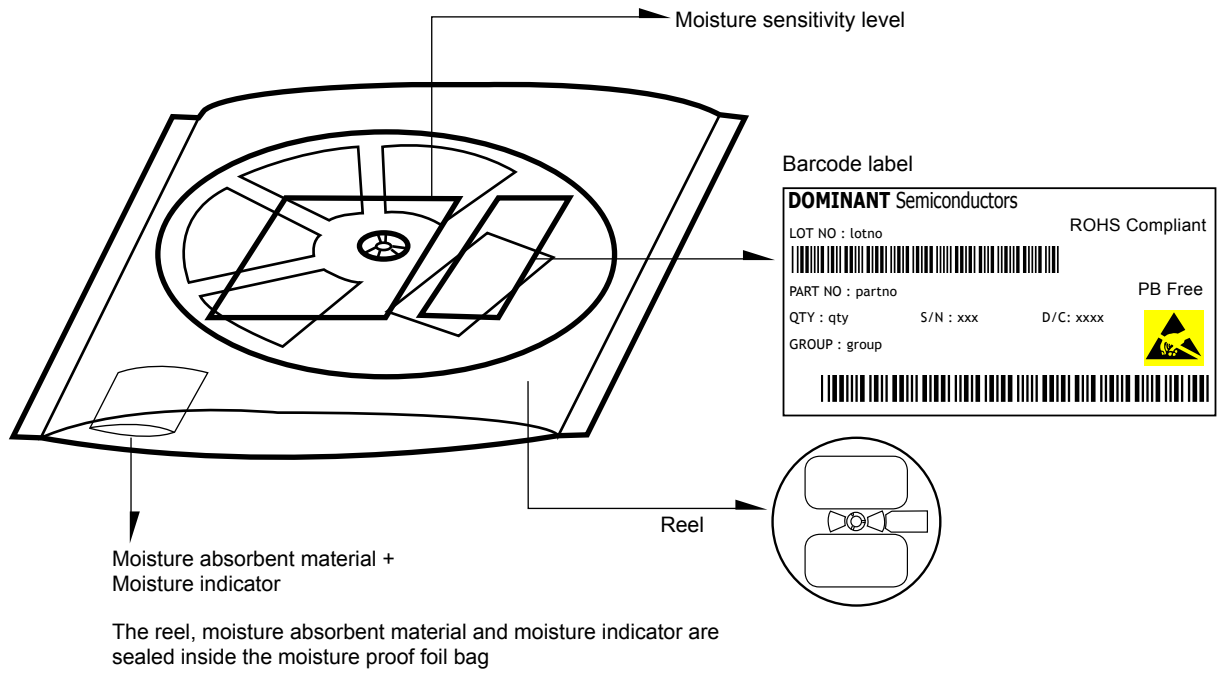

	Average 1pc DomiLED/Multi DomiLED	1 completed bag (2000pcs)
Weight (gram)	0.034	190 ± 10

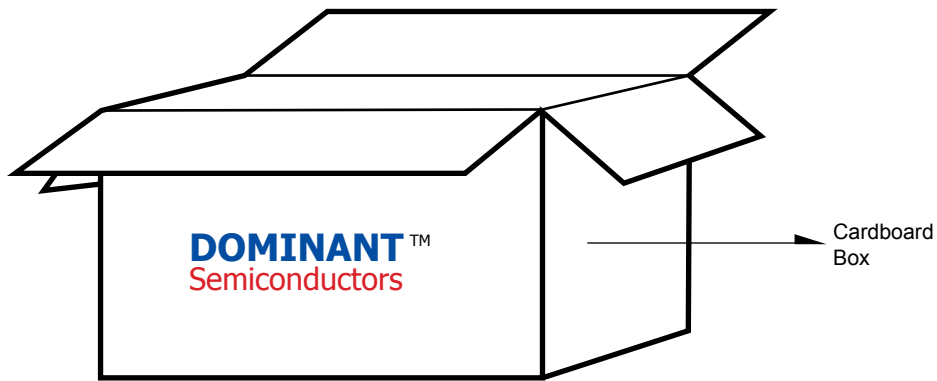

For DomiLED™

Cardboard Box Size	Dimensions (mm)	Empty Box Weight (kg)	Reel / Box	Quantity / Box (pcs)
Small	300 x 250 x 250	0.58	15 reels MAX	30,000 MAX
Large	416 x 516 x 476	1.74	55 reels MAX	110,000 MAX

Recommended Sn-Pb IR-Reflow Soldering Profile

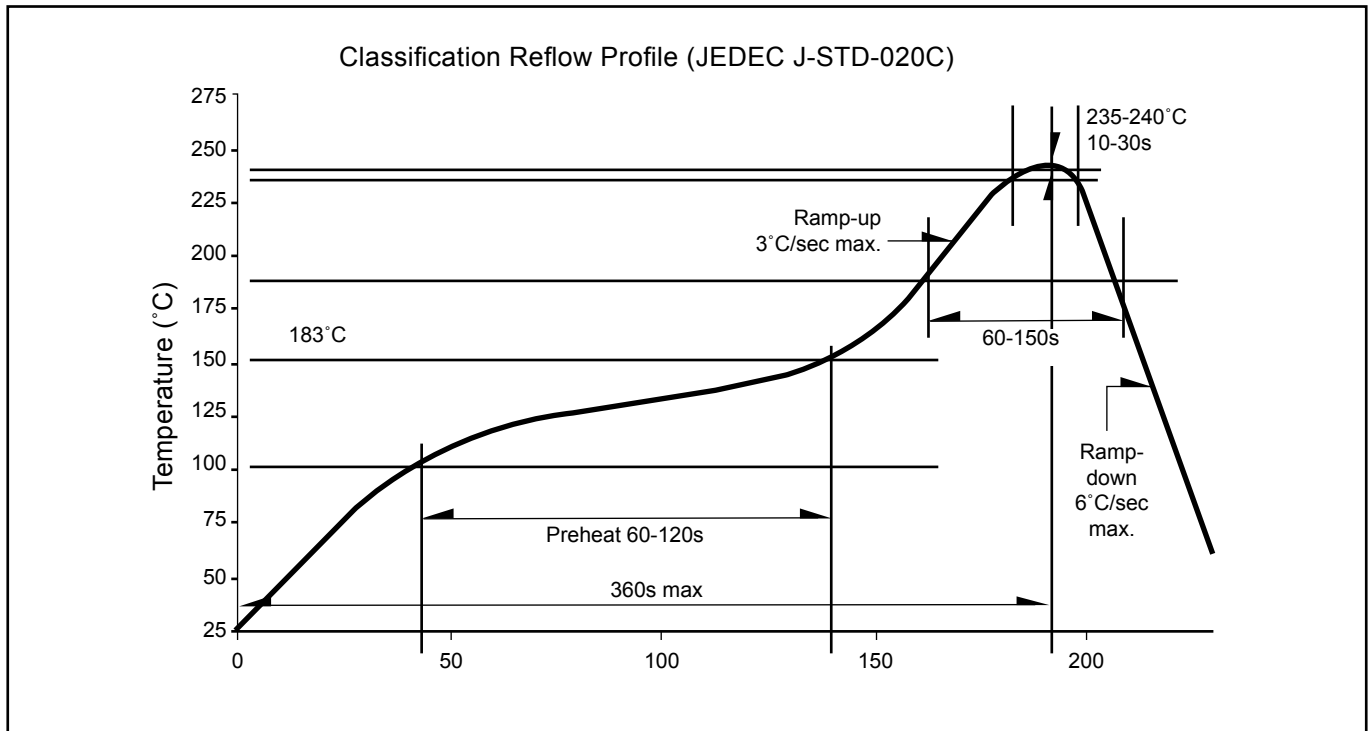

Recommended Pb-free Soldering Profile

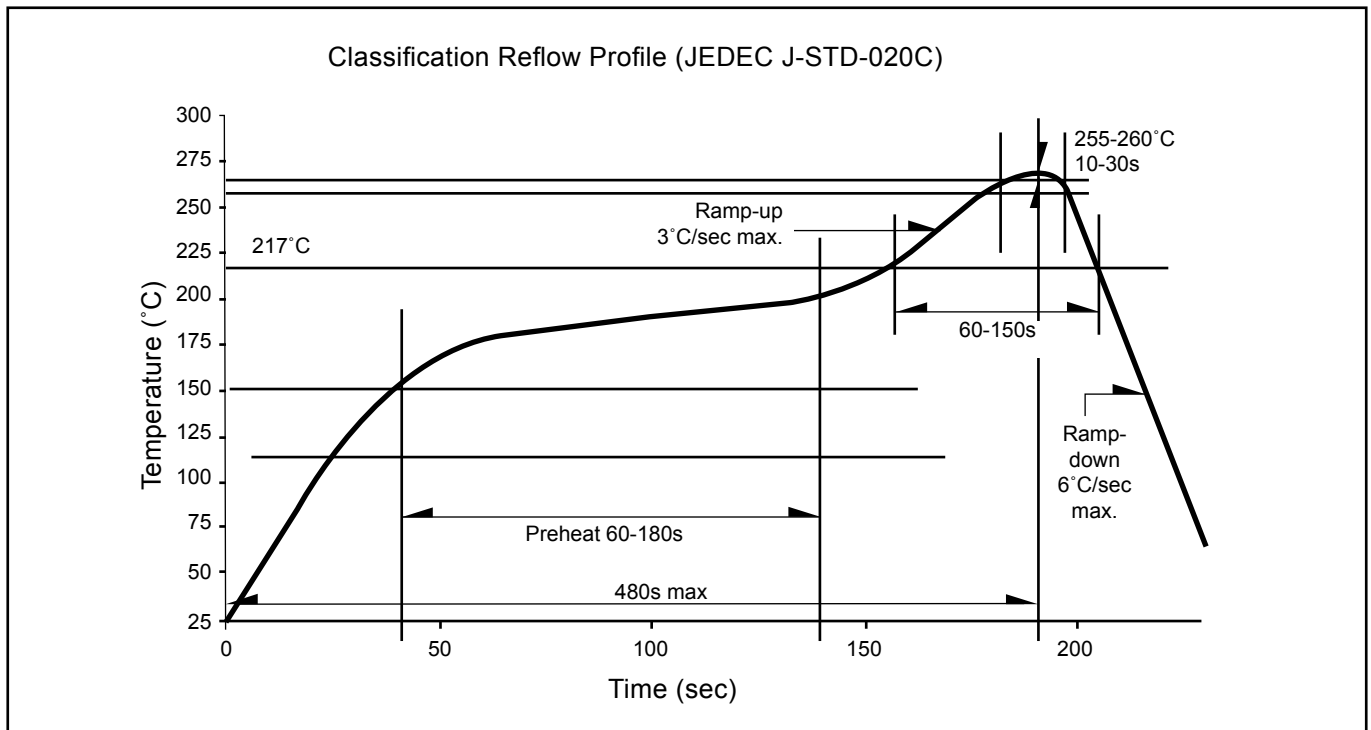

About Us

DOMINANT Semiconductors is a dynamic Malaysian Corporation that is among the world's leading SMT LED Manufacturers. An excellence – driven organization, it offers a comprehensive product range for diverse industries and applications. Featuring an internationally certified quality assurance acclaim, DOMINANT's extra bright LEDs are perfectly suited for various lighting applications in the automotive, consumer and communications as well as industrial sectors. With extensive industry experience and relentless pursuit of innovation, DOMINANT's state-of-art manufacturing, research and testing capabilities have become a trusted and reliable brand across the globe. More information about DOMINANT Semiconductors can be found on the Internet at <http://www.dominant-semi.com>.

Please contact us for more information:

Head Quarter

DOMINANT Semiconductors Sdn. Bhd.
Lot 6, Batu Berendam, FTZ Phase III, 75350 Melaka, Malaysia
Tel: (606) 283 3566 Fax: (606) 283 0566
E-mail: sales@dominant-semi.com

DOMINANT China Sales Office

DOMINANT Semiconductors (Shenzhen) Co. Ltd.
24BC Newbaohui Building, No. 1007 West Nanhai Blvd., Nanshan, Shenzhen, China P.C. 518054
Tel: +86 (755) 86031785 / +86 (755) 86031786 Fax: +86 (755) 86031789
E-mail: sales_china@dominant-semi.com

DOMINANT Korea Sales Office

DOMINANT Semiconductors Korea Inc.
902 Sunil Technopia, 440 Sangdaewon-dong, Jungwon-gu, Sungnam-si, Kyunggi-do, Korea 462726
Tel: 82-31-777-3978 Fax: 82-31-777-3976
E-mail: sales_korea@dominant-semi.com

