

Description

The TOKO DAC2450CT1T is a compact, vertically polarized, dielectric antenna specifically designed for 2.450 GHz applications including IEEE 802.11b/g wireless networking. The antenna unit consists of a dielectric element with a 50Ω center terminal permitting direct connection to a 50Ω printed circuit board pattern without a matching circuit.

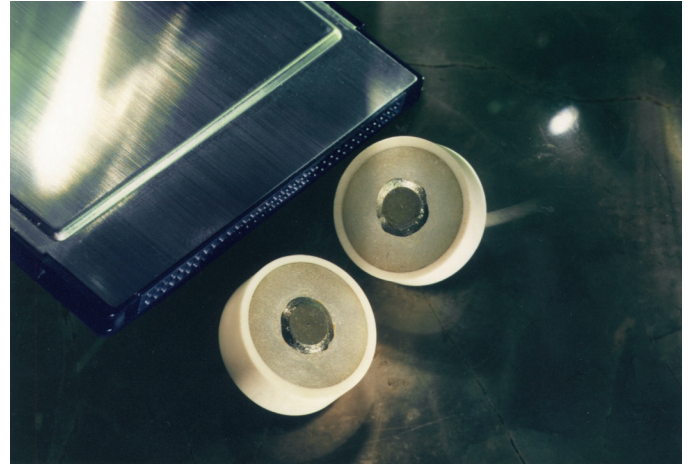

Features

- Miniature footprint: 16mm diameter
- Low profile: 6.5mm max.
- Center Frequency: 2450 MHz
- Bandwidth: ±50 MHz
- Peak Gain: Less than +2.14 dBi (0 dBi typ.)
- Impedance: 50 Ω
- Weight: 4.3 grams
- Operating temperature: -10°C to +60°C
- Storage temperature: -20°C to +85°C

Dimensions

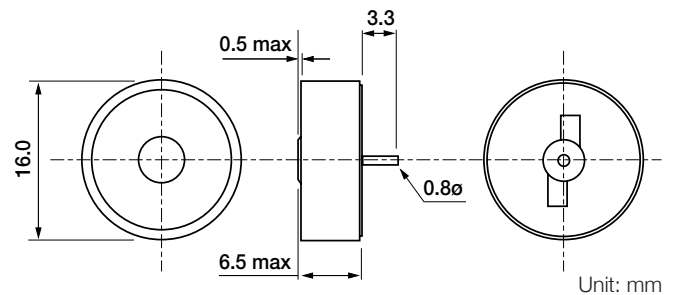

Typical Characteristics

Vertical Directivity Pattern (0°)

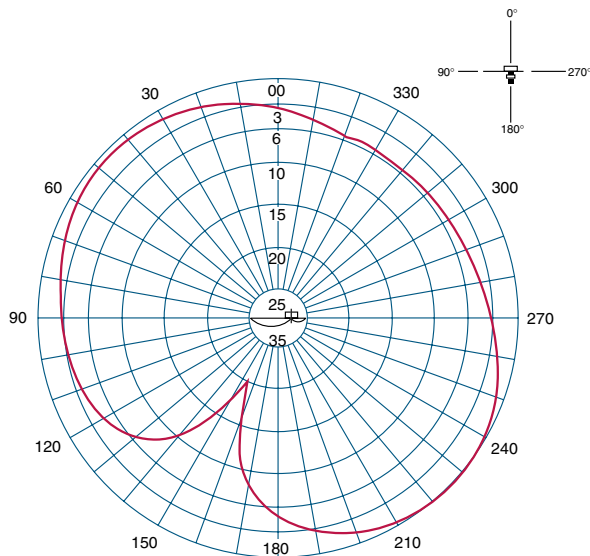

Vertical Directivity Pattern (90°)

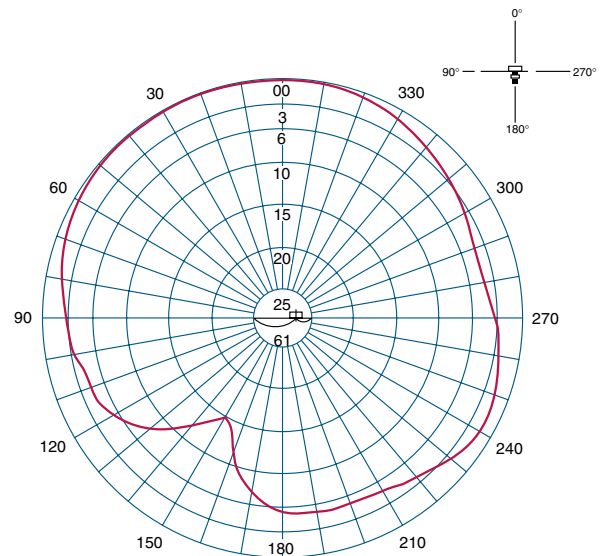

Typical Characteristics

Horizontal Directivity Pattern

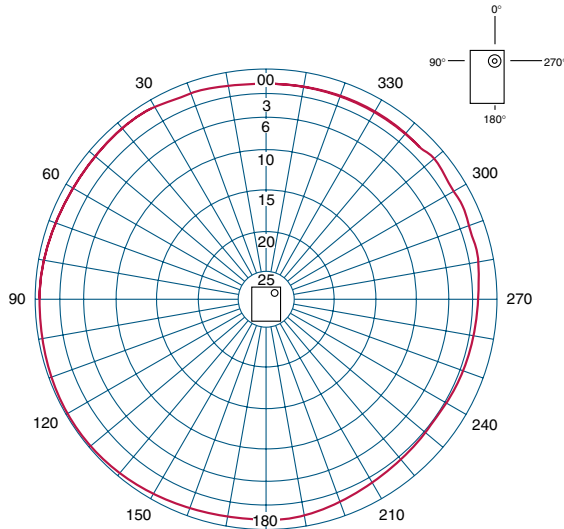

Receiving Signal Response Over Frequency

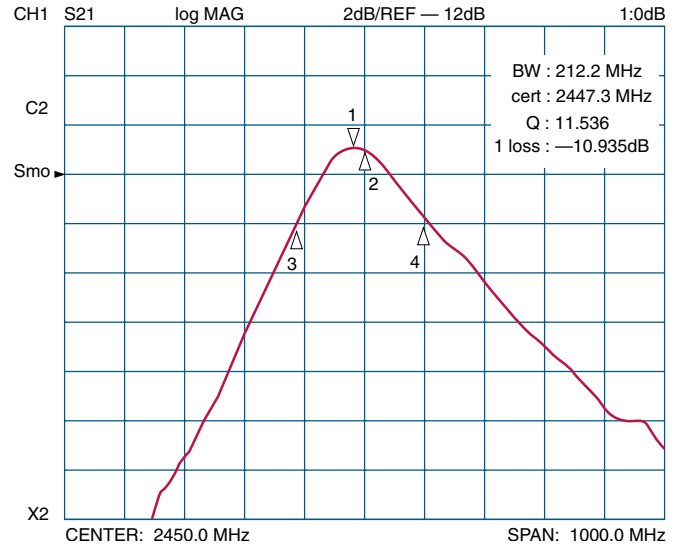

NOTE: All characteristics measured with antenna mounted on a 76.0mm x 50.0mm ground plane of 0.2mm thickness (see Physical Assembly).

Physical Assembly

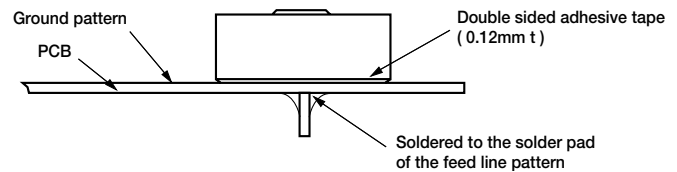
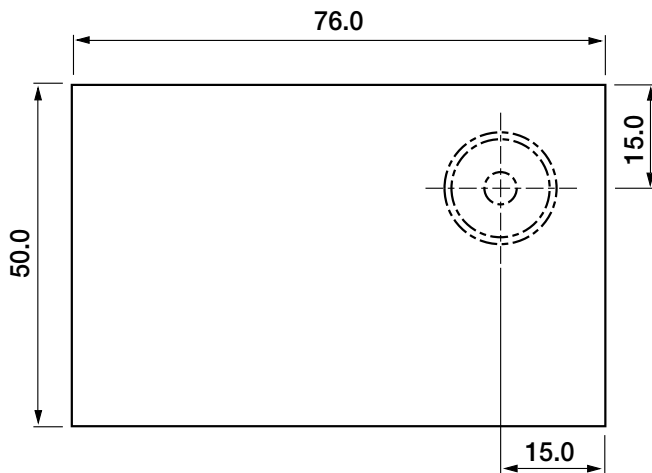

Unit: mm



The information furnished by TOKO, Inc. is believed to be accurate and reliable. However, TOKO reserves the right to make changes or improvements in the design, specification or manufacture of its products without further notice. TOKO does not assume any liability arising from the application or use of any product or circuit described herein, nor for any infringements of patents or other rights of third parties which may result from the use of its products. No license is granted by implication or otherwise under any patent or patent rights of TOKO, Inc.