

## All Band TV Tuner IC (VHF-CATV-UHF)

**Description**

The CXA3225N is a TV tuner monolithic IC which integrates local oscillator and mixer circuits for VHF band, local oscillator and mixer circuits for UHF band, and an IF amplifier onto a single chip. This IC adopts a 20-pin SSOP package and is suitable for miniaturizing voltage synthesizer tuner.

**Features**

- Low power consumption (5 V, 46 mA typ.)
- Single 5 V power supply
- Superior cross modulation
- Balance-type UHF oscillator with good oscillation stability (4 pins)
- IF output can be selected from symmetrical or asymmetrical
- Double-tuned filter can be connected to MIX output
- SSOP 20-pin package

**Applications**

- TV tuners
- VCR tuners
- CATV tuners

**Structure**

Bipolar silicon monolithic IC

20 pin SSOP (Plastic)

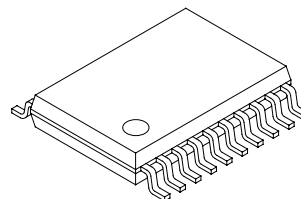
**-Absolute Maximum Ratings (Ta=25 °C)**

- Supply voltage  $V_{CC1}$  -0.3 to +5.5 V
- Storage temperature  $T_{stg}$  -55 to +150 °C
- Allowable power dissipation

$P_D$  465 mW  
(when mounted on a printed circuit board)

**Operating Conditions**

- Supply voltage  $V_{CC1}$  4.75 to 5.30 V
- Operating temperature  $T_{opr}$  -20 to +75 °C

Sony reserves the right to change products and specifications without prior notice. This information does not convey any license by any implication or otherwise under any patents or other right. Application circuits shown, if any, are typical examples illustrating the operation of the devices. Sony cannot assume responsibility for any problems arising out of the use of these circuits.

Block Diagram and Pin Configuration

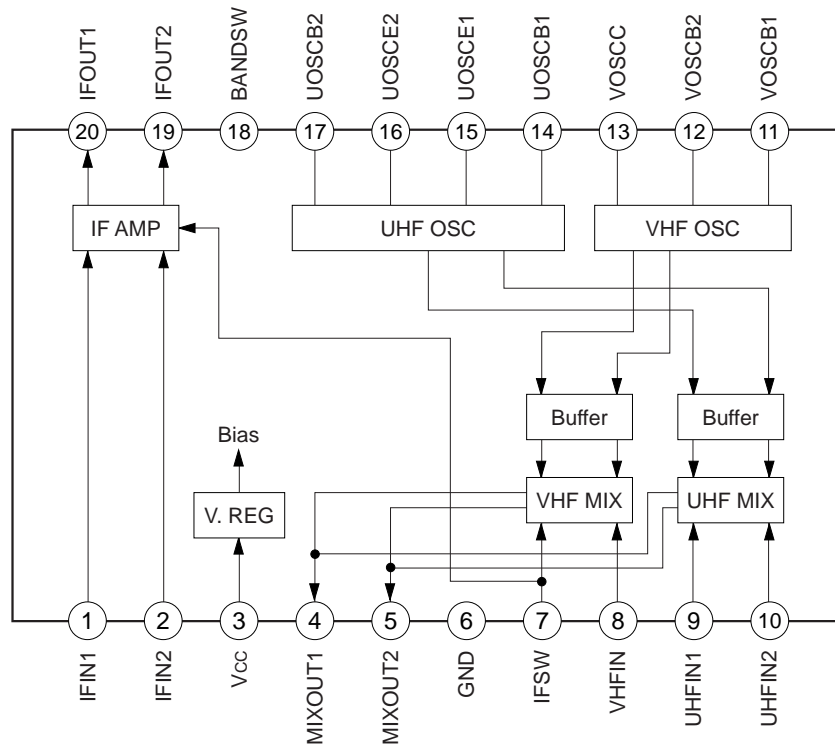

Pin Description and Equivalent Circuit

Pin No.	Symbol	Typical pin voltage (V)	Equivalent circuit	Description
1	IFIN1	2.4		IF amplifier input.
2	IFIN2	2.4		
3	Vcc	5.0		Power supply.
4	MIXOUT1	4.4 during VHF reception		Mixer outputs. These pins are output with open collector, and they must be connected to the power supply via the load.
		4.3 during UHF reception		
5	MIXOUT2	4.4 during VHF reception		
		4.3 during UHF reception		
6	GND	0		GND.
7	IFSW	0.8 (when open)		Switching of VHF input ground and IF symmetrical/asymmetrical output. Asymmetrical output is selected for open state; symmetrical output for grounding. When used as an asymmetrical output, ground this pin with a capacitor.
8	VHFIN	2.4 during VHF reception		VHF inputs. Input format is asymmetrical input.
		2.6 during UHF reception		
9	UHFIN1	2.6 during VHF reception		UHF inputs. Input the signal to Pins 9 and 10 symmetrically or ground Pin 10 with a capacitor and input to Pin 9.
		2.3 during UHF reception		
10	UHFIN2	2.6 during VHF reception		
		2.3 during UHF reception		

Pin No.	Symbol	Typical pin voltage (V)	Equivalent circuit	Description
11	VOSCB1	2.1 during VHF reception 2.2 during UHF reception		External resonance circuit connection for VHF oscillators. Pin 12 is grounded with a capacitor.
12	VOSCB2	2.1 during VHF reception 2.2 during UHF reception		
13	VOSCC	4.2 during VHF reception 5 during UHF reception		
14	UOSCB1	2.3 during VHF reception 2.1 during UHF reception		External resonance circuit connection for UHF oscillators.
15	UOSCE1	1.8 during VHF reception 1.5 during UHF reception		
16	UOSCE2	1.8 during VHF reception 1.4 during UHF reception		
17	UOSCB2	2.3 during VHF reception 2.1 during UHF reception		
18	BANDSW	—		Band switching. UHF operation for 3.0 V or more, and VHF operation for 0.5 V or less or open state.
19	IFOUT2	2.8 during symmetrical output 4.5 during asymmetrical output		IF output during symmetrical output. The opposite phase signal to Pin 20 is output during symmetrical output. When asymmetrical output is selected, the signal is not output.

Pin No.	Symbol	Typical pin voltage (V)	Equivalent circuit	Description
20	IFOUT1	2.8 during symmetrical output		IF output.
		2.8 during asymmetrical output		

**Electrical Characteristics**

See the Electrical Characteristics Measurement Circuit  
(Ta=25 °C, Vcc=5 V)

Item	Symbol	Measurement conditions	Min.	Typ.	Max.	Unit
Circuit current	IccVU	VHF operation asymmetrical output no input signal	35	46	55	mA
	IccVB	VHF operation symmetrical output no input signal	47	58	67	mA
	IccUU	UHF operation asymmetrical output no input signal	39	50	59	mA
	IccUB	UHF operation symmetrical output no input signal	51	62	71	mA
Conversion gain *1	CG1U	VHF operation f <sub>RF</sub> =50 MHz asymmetrical output	20	23	26	dB
	CG2U	VHF operation f <sub>RF</sub> =430 MHz asymmetrical output	20	23	26	dB
	CG3U	UHF operation f <sub>RF</sub> =430 MHz asymmetrical output	23	26	29	dB
	CG4U	UHF operation f <sub>RF</sub> =850 MHz asymmetrical output	23	26	29	dB
	CG1B *4	VHF operation f <sub>RF</sub> =50 MHz symmetrical output	29	32	35	dB
	CG2B *4	VHF operation f <sub>RF</sub> =430 MHz symmetrical output	29	32	35	dB
	CG3B *4	UHF operation f <sub>RF</sub> =430 MHz symmetrical output	32	35	38	dB
	CG4B *4	UHF operation f <sub>RF</sub> =850 MHz symmetrical output	32	35	38	dB
Noise figure *1, *2	NF1	VHF operation f <sub>RF</sub> =50 MHz asymmetrical output		12	16	dB
	NF2	VHF operation f <sub>RF</sub> =430 MHz asymmetrical output		13	17	dB
	NF3	UHF operation f <sub>RF</sub> =430 MHz asymmetrical output		10	13	dB
	NF4	UHF operation f <sub>RF</sub> =850 MHz asymmetrical output		12	15	dB
1 % cross modulation *1 *3	CM1	VHF operation f <sub>D</sub> =50 MHz f <sub>UD</sub> =±12 MHz asymmetrical output	99	103		dBμ
	CM2	VHF operation f <sub>D</sub> =430 MHz f <sub>UD</sub> =±12 MHz asymmetrical output	96	100		dBμ
	CM3	UHF operation f <sub>D</sub> =430 MHz f <sub>UD</sub> =±12 MHz asymmetrical output	96	100		dBμ
	CM4	UHF operation f <sub>D</sub> =850 MHz f <sub>UD</sub> =±12 MHz asymmetrical output	95	99		dBμ
Maximum output power	Pomax (sat)	50 Ω load, asymmetrical output	7	10		dBm
Switch ON drift	Δfsw1	VHF operation f <sub>OSC</sub> =100 MHz Δf from 3 seconds to 3 minutes after switch ON			±300	kHz
	Δfsw2	VHF operation f <sub>OSC</sub> =470 MHz Δf from 3 seconds to 3 minutes after switch ON			±600	kHz
	Δfsw3	UHF operation f <sub>OSC</sub> =470 MHz Δf from 3 seconds to 3 minutes after switch ON			±350	kHz
	Δfsw4	UHF operation f <sub>OSC</sub> =895 MHz Δf from 3 seconds to 3 minutes after switch ON			±350	kHz

\*1 Value measured with untuned input.

\*2 NF meter direct-reading value (DSB measurement).

\*3 Value with a desired reception signal input level of -30 dBm, an interference signal of 100 kHz/30 % AM, and an interference signal level where S/I=46 dB measured with a spectrum analyzer.

\*4 Value which is measured as 420 Ω load impedance and compensated loss by 180 Ω resistor connected to Pins 19 and 20.

Item	Symbol	Measurement conditions	Min.	Typ.	Max.	Unit
Supply voltage drift	$\Delta f_{st1}$	VHF operation $f_{osc}=100$ MHz $\Delta f$ when $V_{cc} 5 V \pm 5\%$ variation			$\pm 200$	kHz
	$\Delta f_{st2}$	VHF operation $f_{osc}=470$ MHz $\Delta f$ when $V_{cc} 5 V \pm 5\%$ variation			$\pm 250$	kHz
	$\Delta f_{st3}$	UHF operation $f_{osc}=470$ MHz $\Delta f$ when $V_{cc} 5 V \pm 5\%$ variation			$\pm 150$	kHz
	$\Delta f_{st4}$	UHF operation $f_{osc}=895$ MHz $\Delta f$ when $V_{cc} 5 V \pm 5\%$ variation			$\pm 150$	kHz
Band switching voltage	$V_{swV}$	VHF operation	0		0.5	V
	$V_{swU}$	UHF operation	3		5.5	V

## Description of Operation

(See the Electrical Characteristics Measurement Circuit.)

### VHF oscillator circuit

This circuit is a differential amplifier-type oscillator circuit. Pin 13 is the output, Pin 11 is the input and Pin 12 is the GND.

Oscillation is performed by connecting an LC resonance circuit including a variable capacitance diode, to Pin 13 via coupled capacitance, inputting to Pin 11 with feedback capacitance, and applying positive feedback.

Note that if the capacitance across Pins 11 and 13 is too large, positive feedback may be applied via a parasitic capacitance causing undesired stray oscillation. The resistor connected Pin 11 prevents the parasitic oscillation.

### VHF mixer circuit

The mixer circuit employs a double balanced mixer with little local oscillation signal leakage. The input format is the base input type. Pin 7 is grounded and the RF signal is input to Pin 8. The RF signal is converted to IF frequency by the signal supplied from the oscillator and then output to Pins 4 and 5. Pins 4 and 5 are open collectors, so the power must be supplied externally. The electric potential of Pins 4 and 5 at this time must be DC 4.0 V or more.

### UHF oscillator circuit

This oscillator circuit is designed so that two collector ground type Colpitts oscillators perform the differential oscillation operation via an LC resonance circuit including a variable capacitance diode. The resonance capacitors which configure the Colpitts oscillator are connected between Pins 14 and 15, 15 and 16, 16 and 17. The LC resonance circuit including the variable capacitance diode Di is connected between Pins 14 and 17.

### UHF mixer circuit

This circuit employs a double balanced mixer like the VHF mixer circuit. The RF signal is input to Pins 9 and 10. There are two input methods; one is the symmetrical input where the signal is input to Pins 9 and 10 differentially and the other is the asymmetrical input where Pin 9 is grounded via a capacitor and the signal is input to Pin 10.

Pins 4 and 5 are the mixer outputs. Pins 4 and 5 are open collectors, so the power must be supplied externally. The electric potential of Pins 4 and 5 at this time must be DC 4.0 V or more.

### IF amplifier circuit

The signals frequency converted by the mixer are output from Pins 4 and 5, and then they are input to the IF input Pins 1 and 2 via the external tuned circuit. As the IF tuned circuit, the single-tuned circuit shown in the Electrical Characteristics Measurement Circuit or double-tuned circuits can be connected. When used as the single-tuned filter, be sure to connect it via the capacitor so that the DC voltage may not be applied to Pins 1 and 2.

The signal amplified by the IF amplifier is output with symmetrical or asymmetrical output format. Selecting symmetrical or asymmetrical is performed at Pin 7. Asymmetrical output when Pin 7 is grounded via the capacitor; symmetrical output when it is directly grounded. During symmetrical output, SAW filter direct connection is possible and during asymmetrical output. During asymmetrical output, output is performed from Pin 20, and during symmetrical output, output is performed from Pins 19 and 20. The output impedance is approximately 30  $\Omega$ .

### U/V switch circuit

UHF operation is chosen by applying voltage of 3 V or more to Pin 18, VHF operation for 0 V or open.



**Notes on Operation**

1. Care should be taken for grounding, etc. when placing external parts as the operating frequencies are high.
2. Be sure to design the printed circuit board considering the radiation of heat by placing the GND pattern at the bottom of the IC.
3. Care should also be taken to prevent electrostatic damage because of using high frequency process.

Example of Representative Characteristics

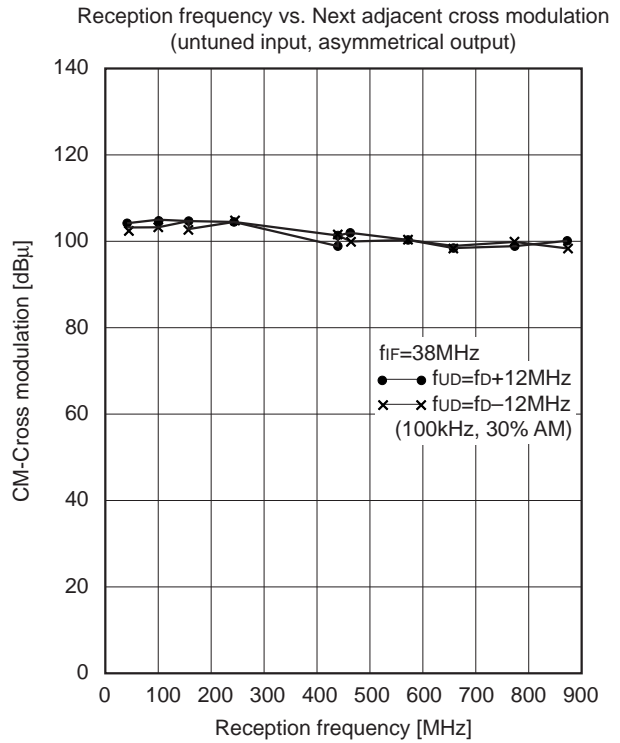
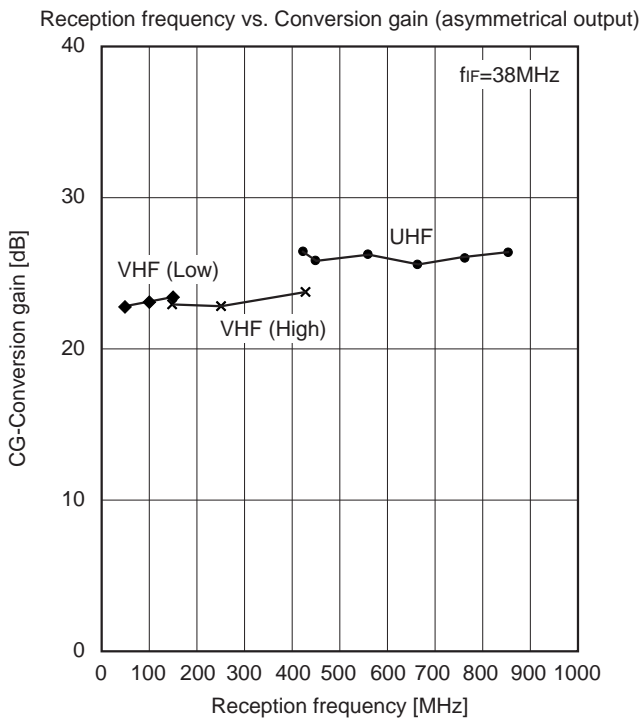
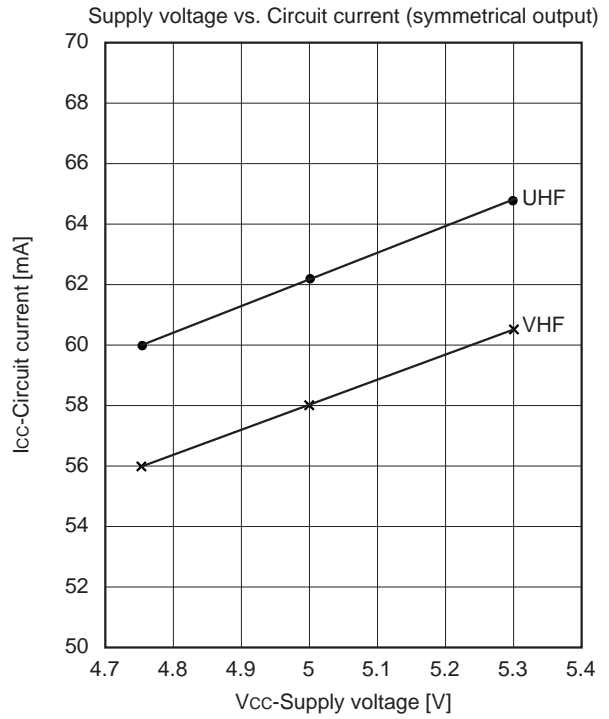
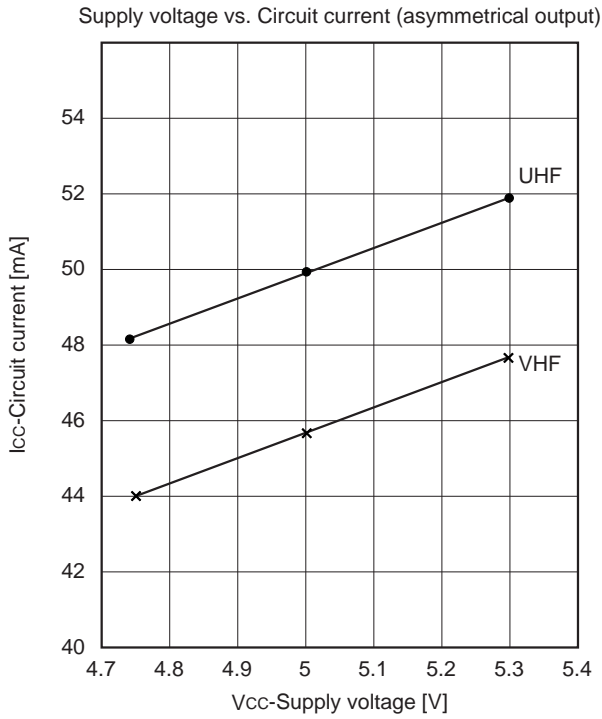

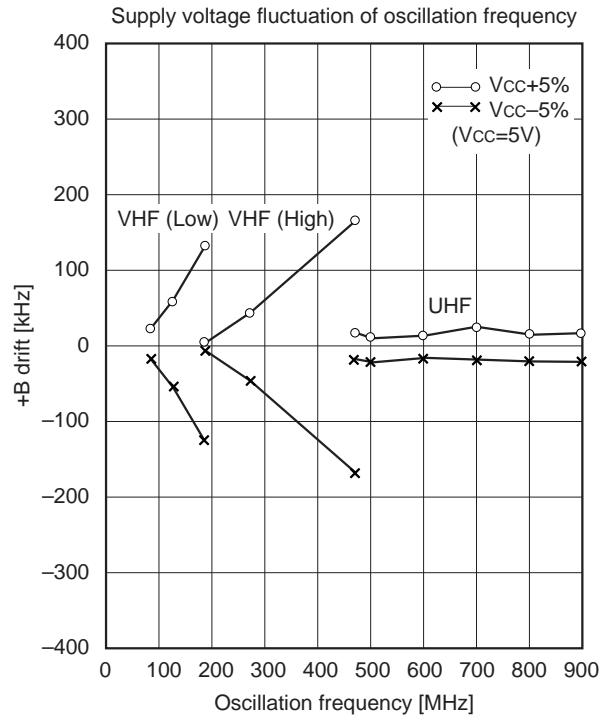
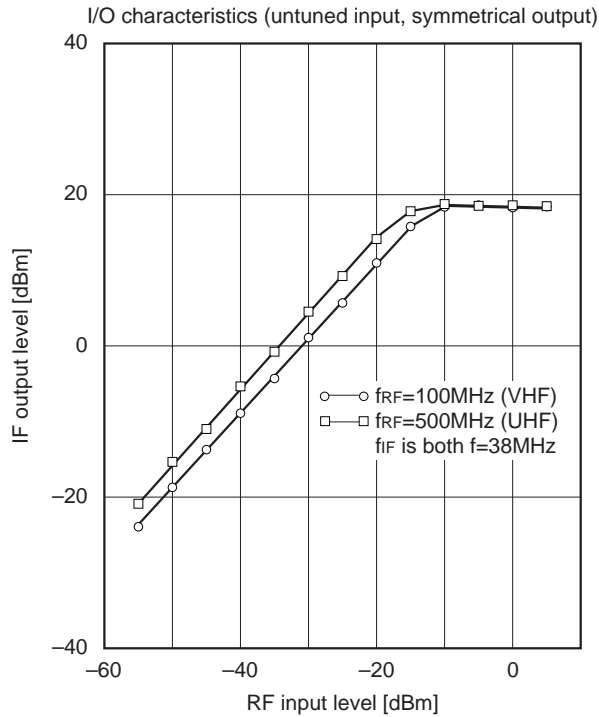
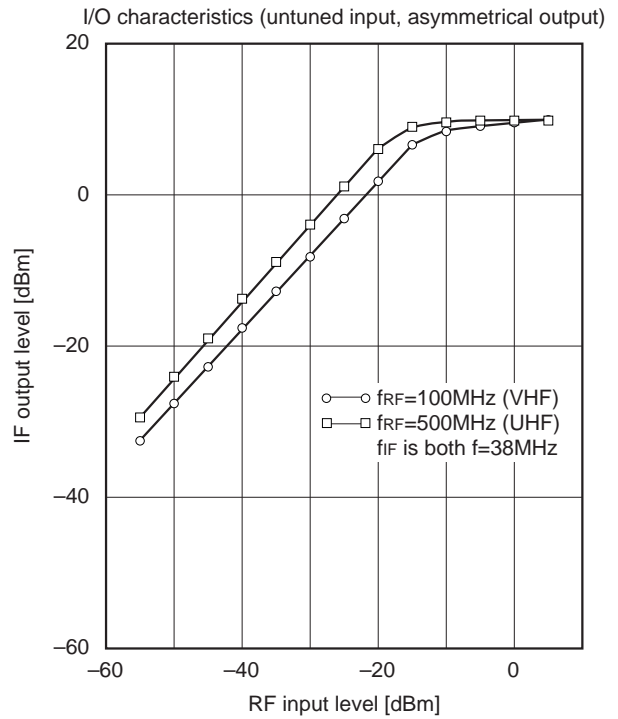
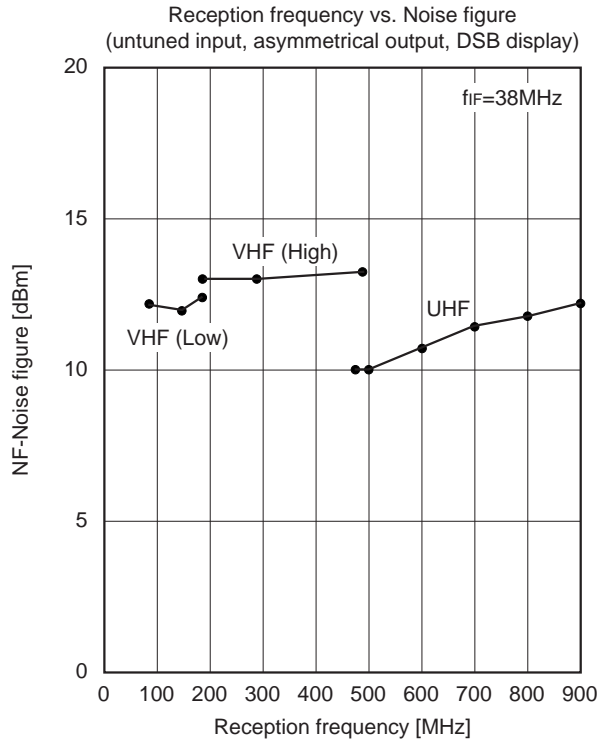

Electrical Characteristics Measurement Circuit (asymmetrical output)

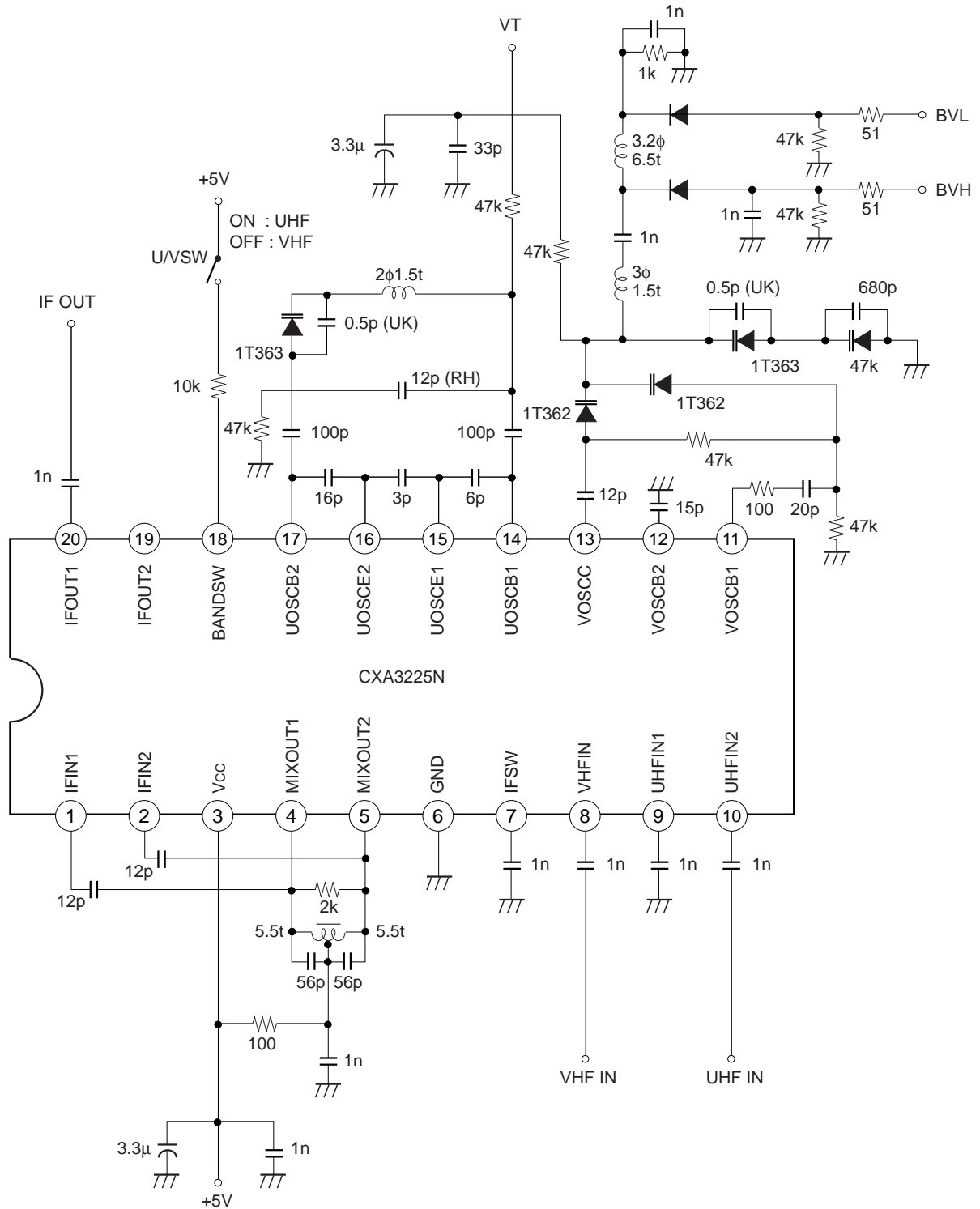



VHF Input Impedance

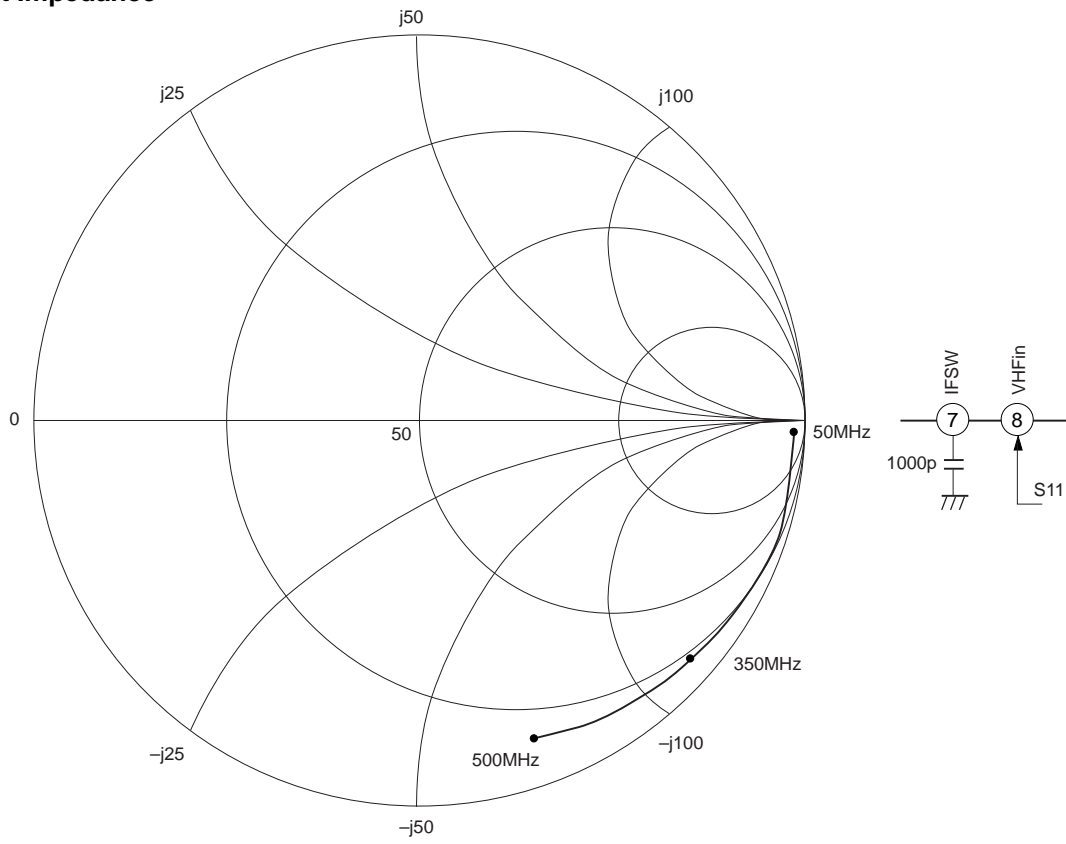

UHF Input Impedance

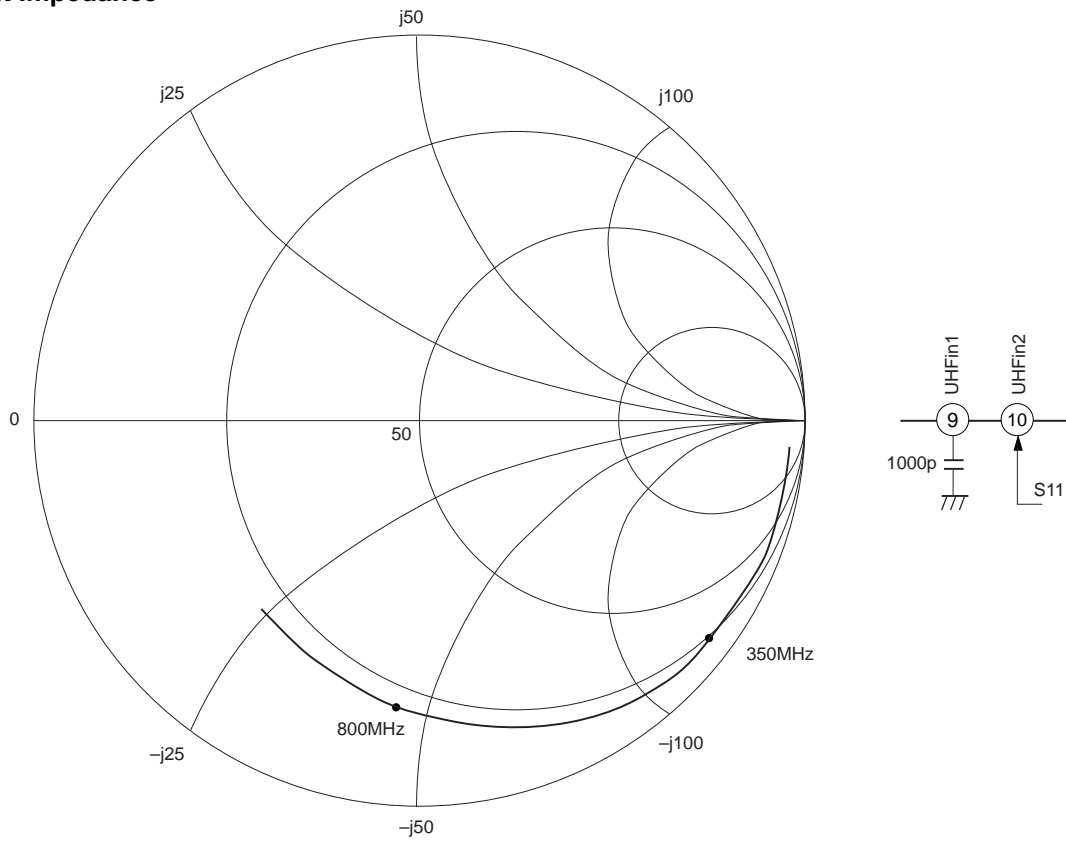

**IF Output Impedance (symmetrical output)**

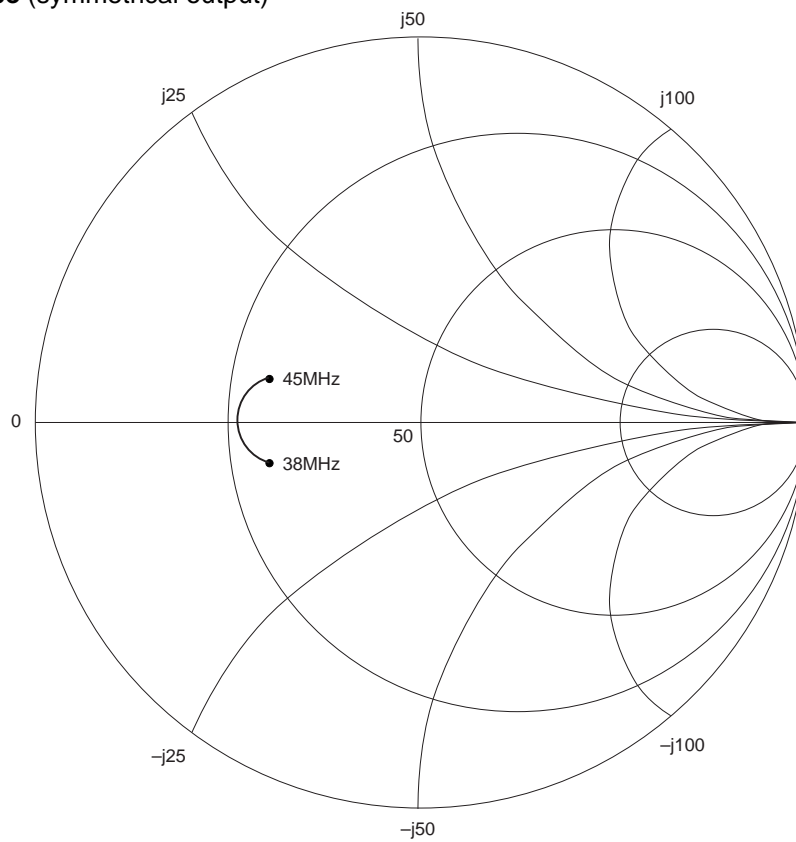

**IF Output Impedance (asymmetrical output)**

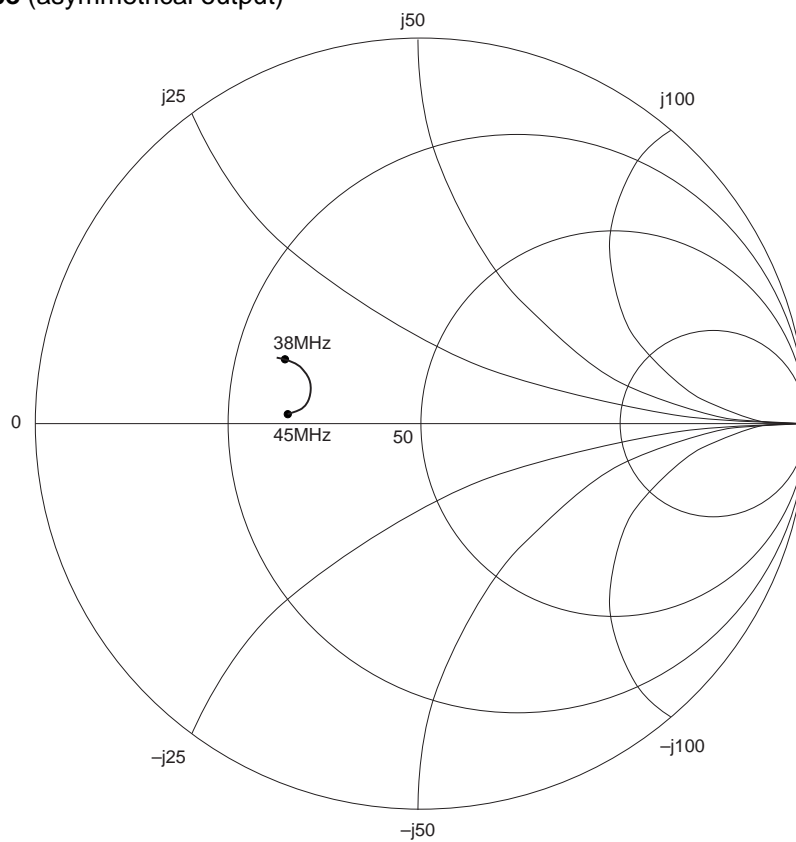

Package Outline Unit : mm

20PIN SSOP (PLASTIC)

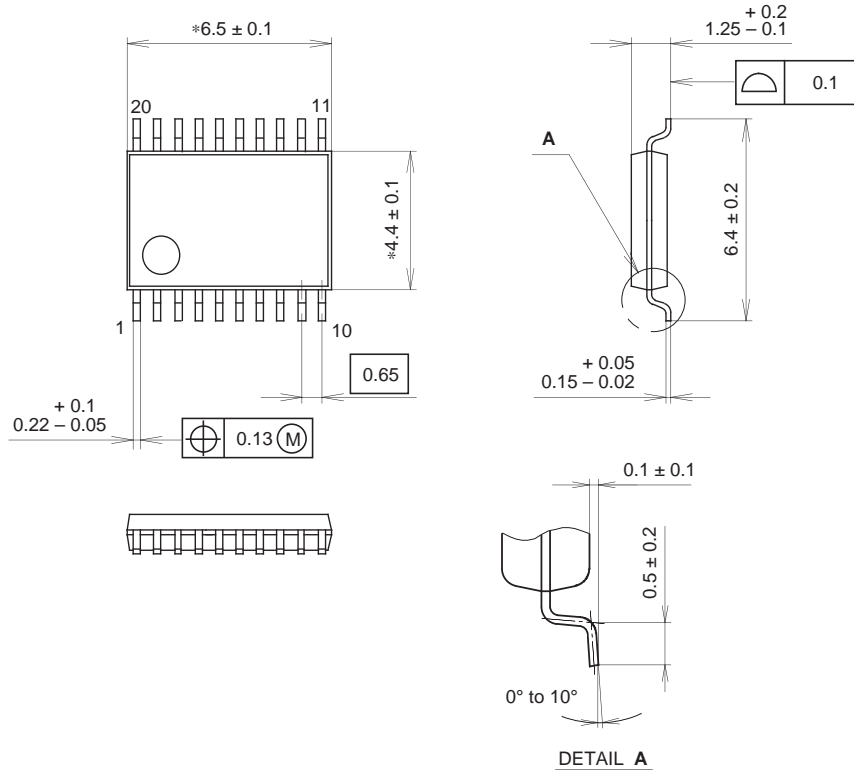

NOTE: Dimension "\*" does not include mold protrusion.

PACKAGE STRUCTURE

SONY CODE	SSOP-20P-L01
EIAJ CODE	SSOP020-P-0044
JEDEC CODE	_____

PACKAGE MATERIAL	EPOXY RESIN
LEAD TREATMENT	SOLDER / PALLADIUM PLATING
LEAD MATERIAL	42/COPPER ALLOY
PACKAGE MASS	0.1g

NOTE : PALLADIUM PLATING

This product uses S-PdPPF (Sony Spec.-Palladium Pre-Plated Lead Frame).