

SAMSUNG

Mod. TVC - CX 6837 AN AW

CX 6840 AW

telaio Z 68

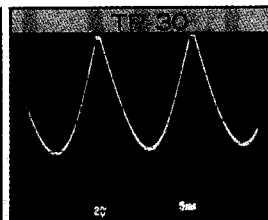
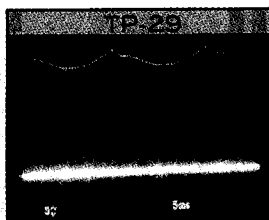
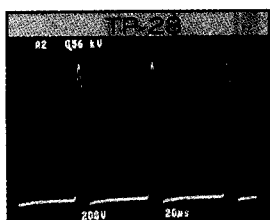
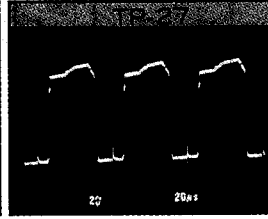
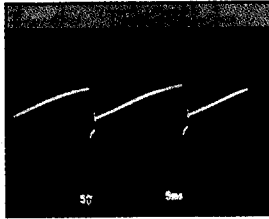
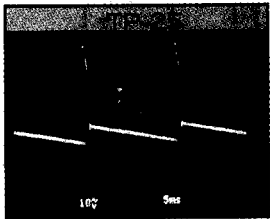
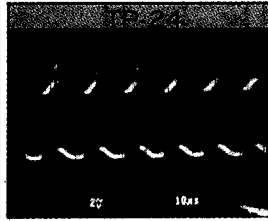
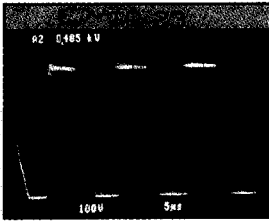
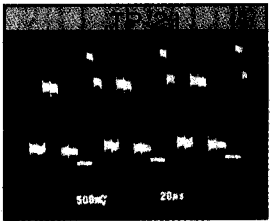
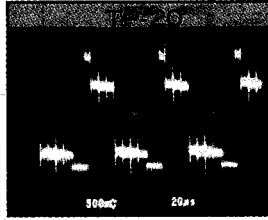
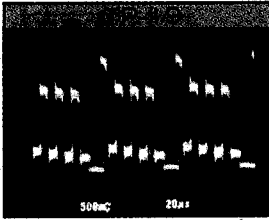
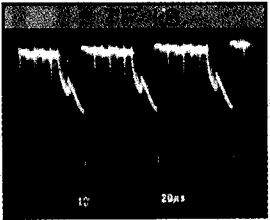
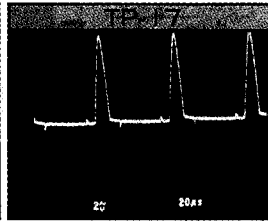
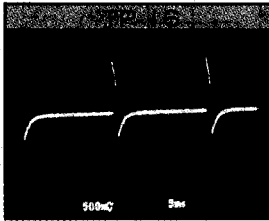
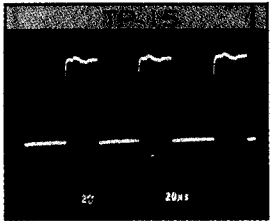
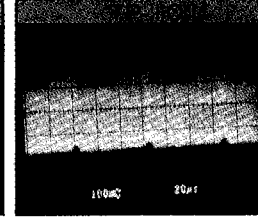
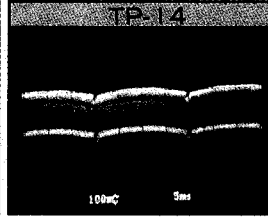
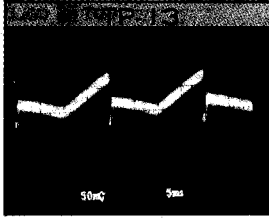
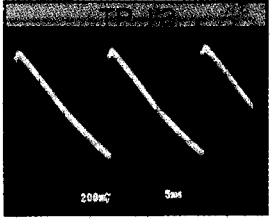

PWB-CRT

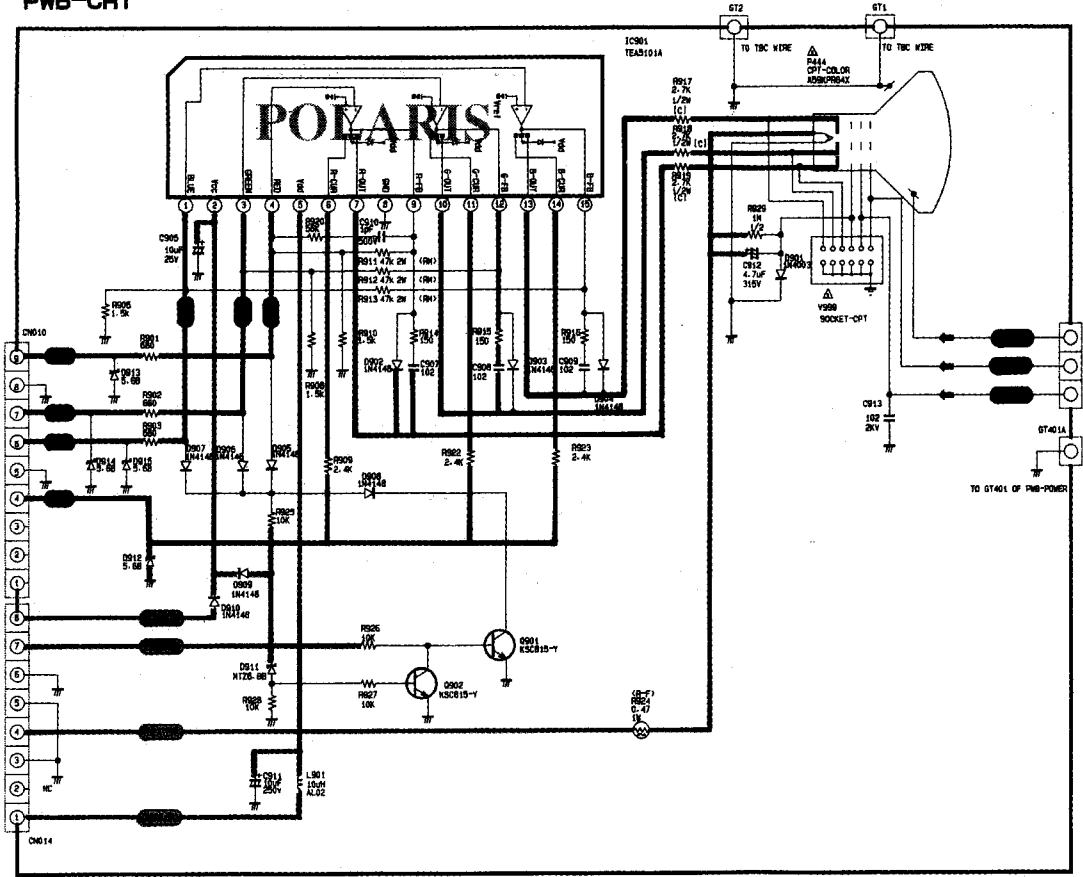

PWB-TRANSMITTER

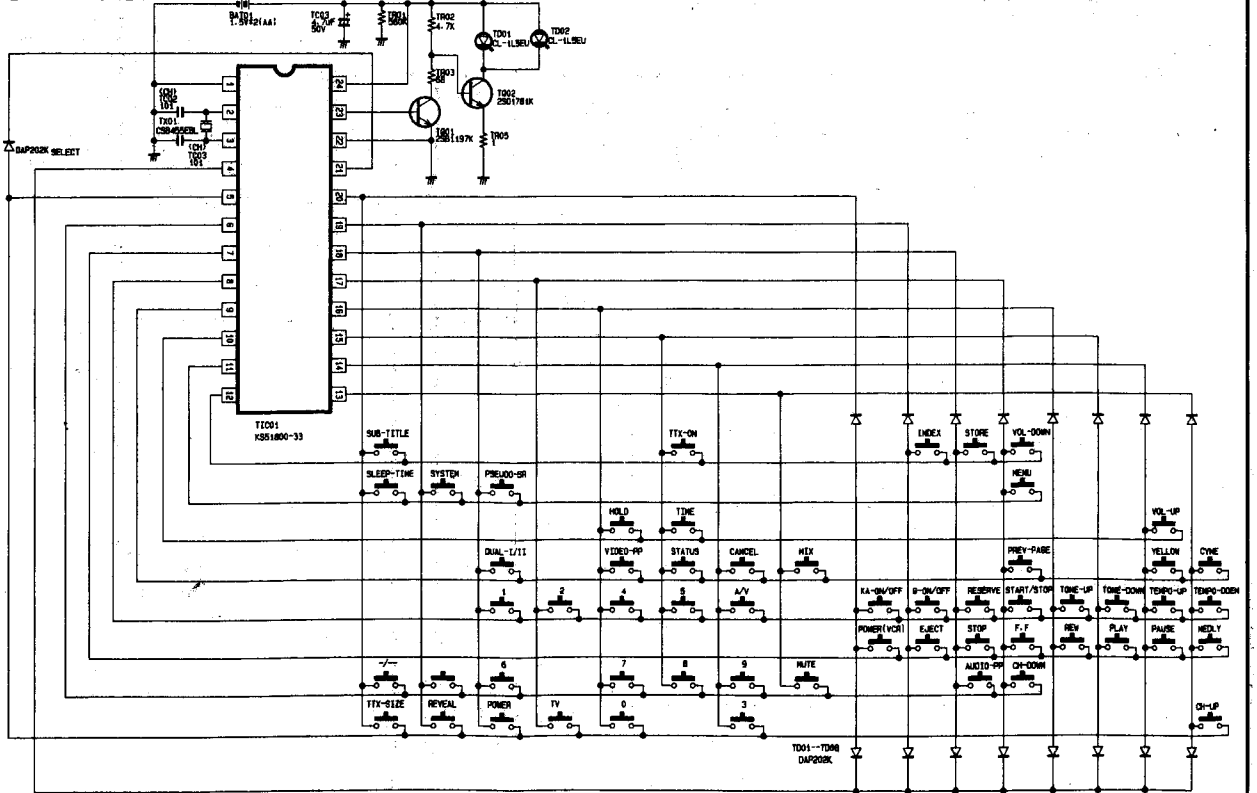

PWB-F /AV

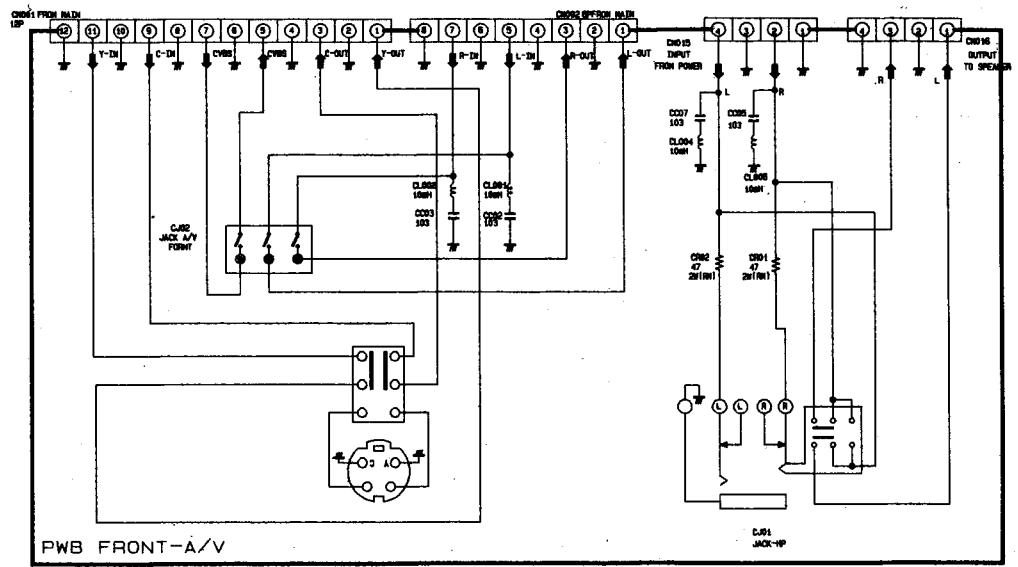
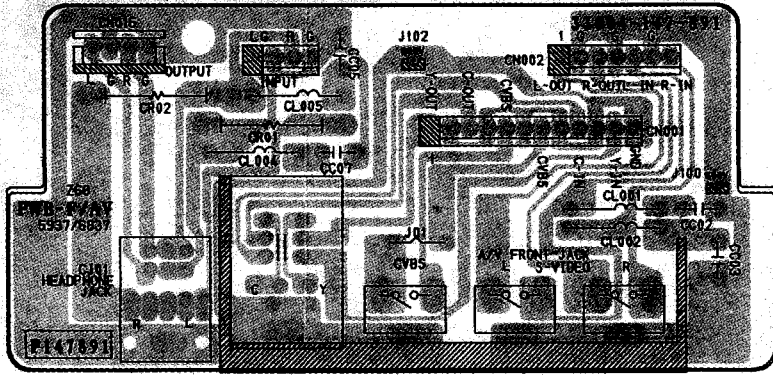

PWB-PRE, AMP

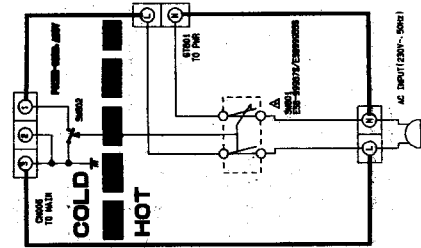
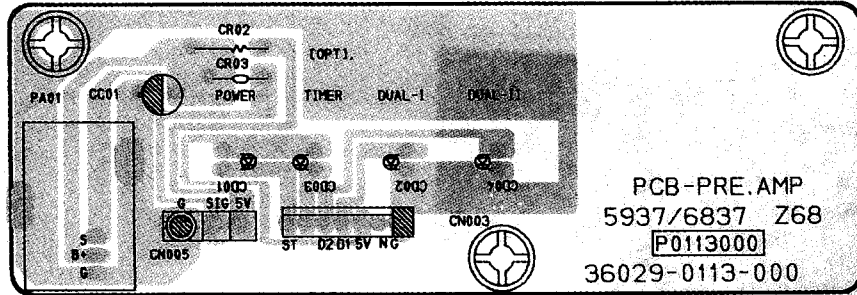

PWB-CONNECTOR

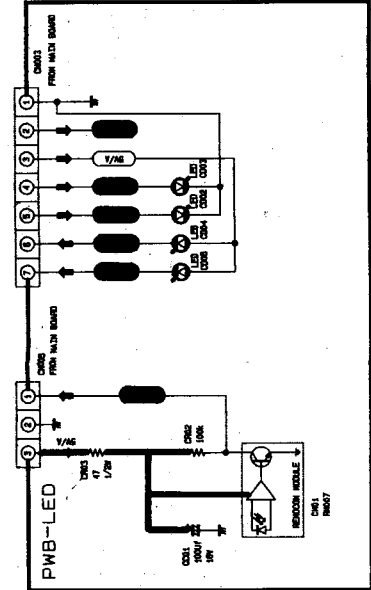
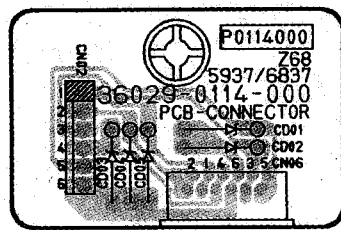

PWB-CONTROL

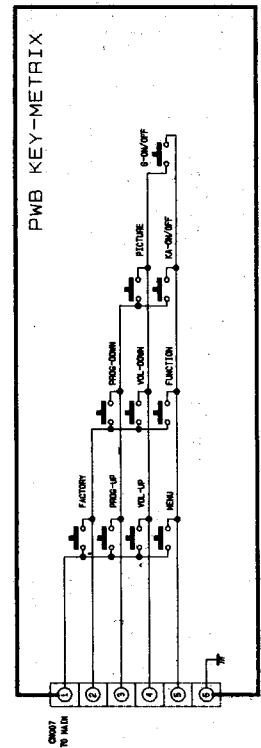
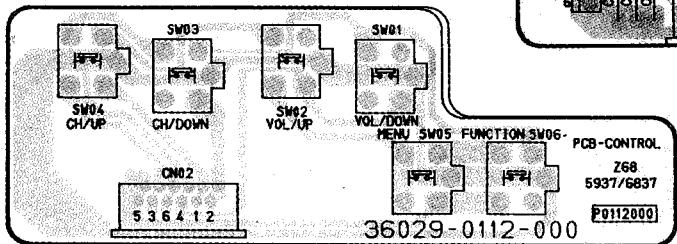

PWB-POWER

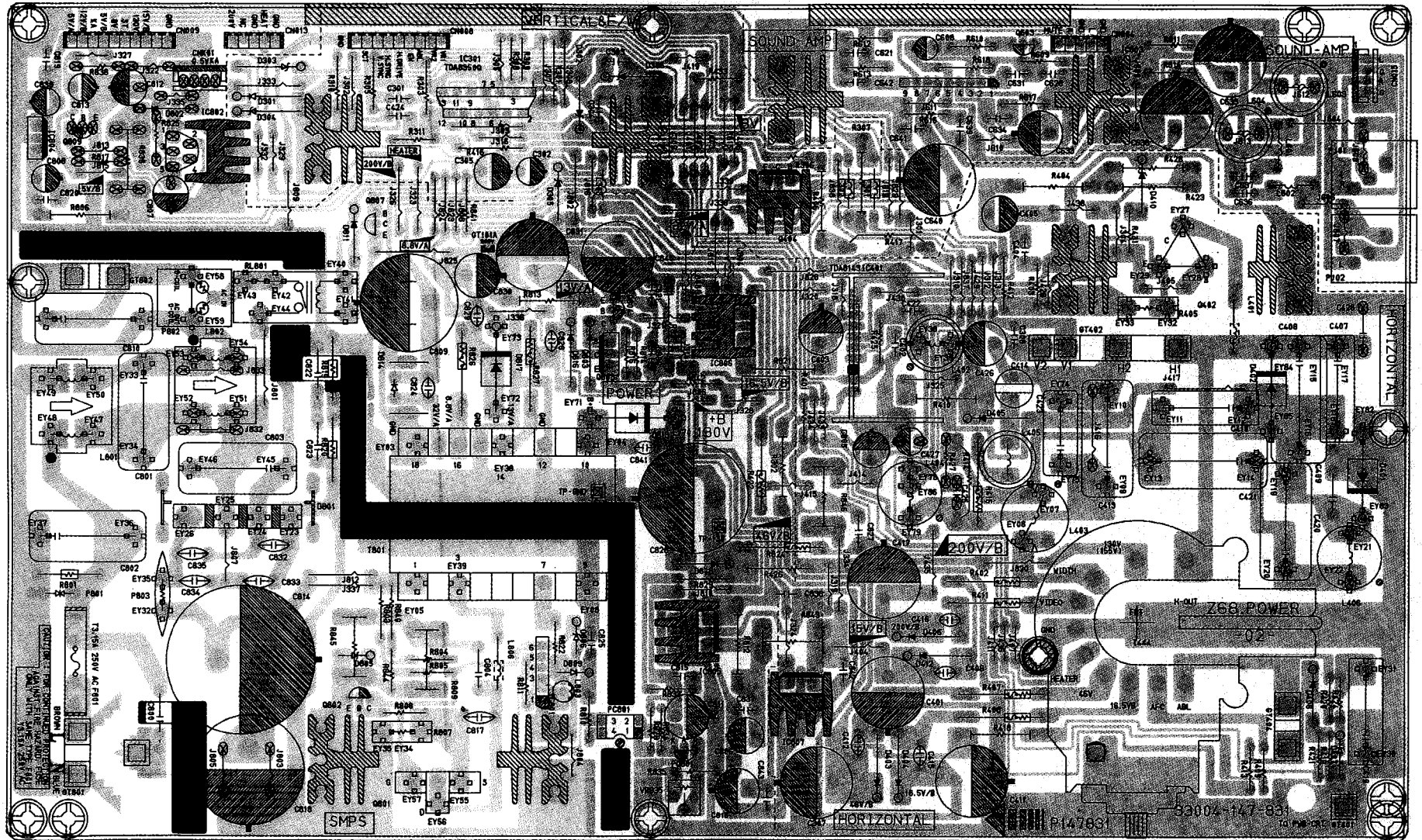

SCHEMATIC DIAGRAM

CHASSIS: Z-68
MODEL: CX5937AN
BOARD NAME: MAIN

B

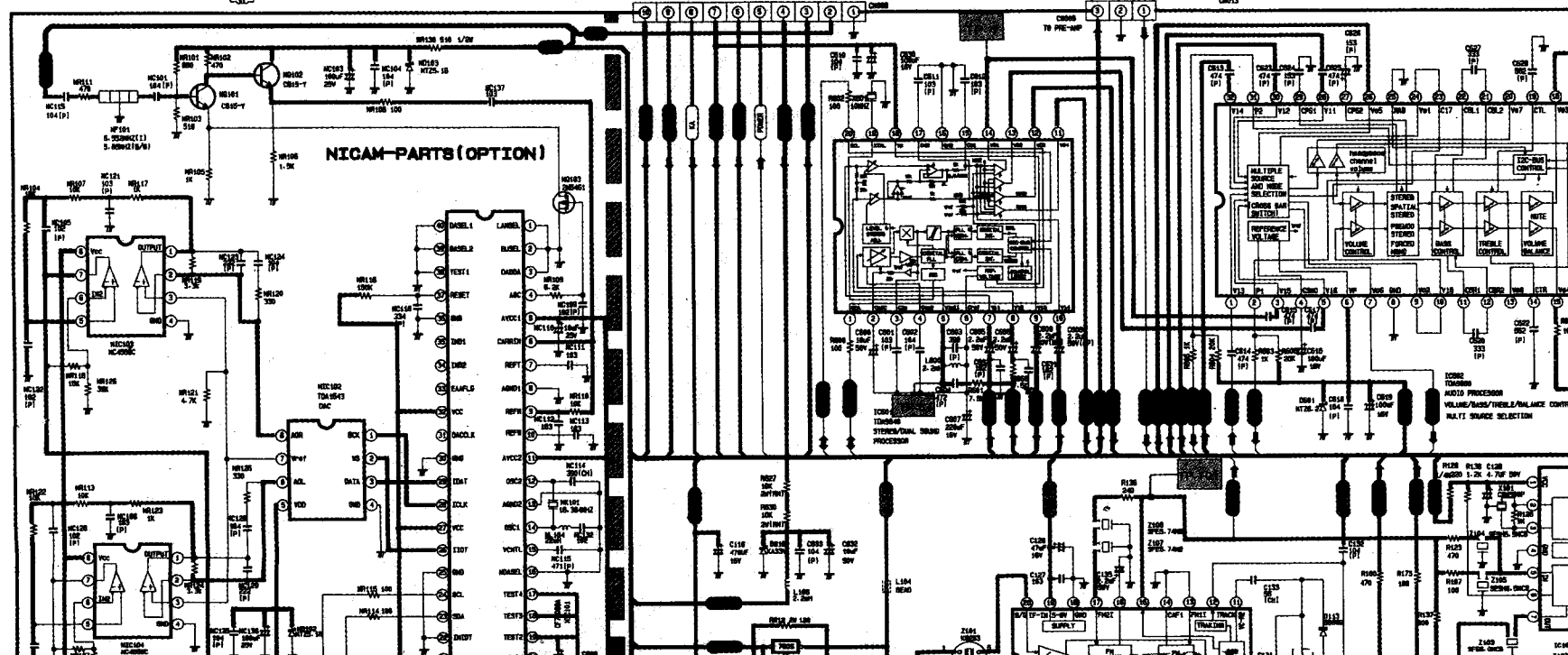
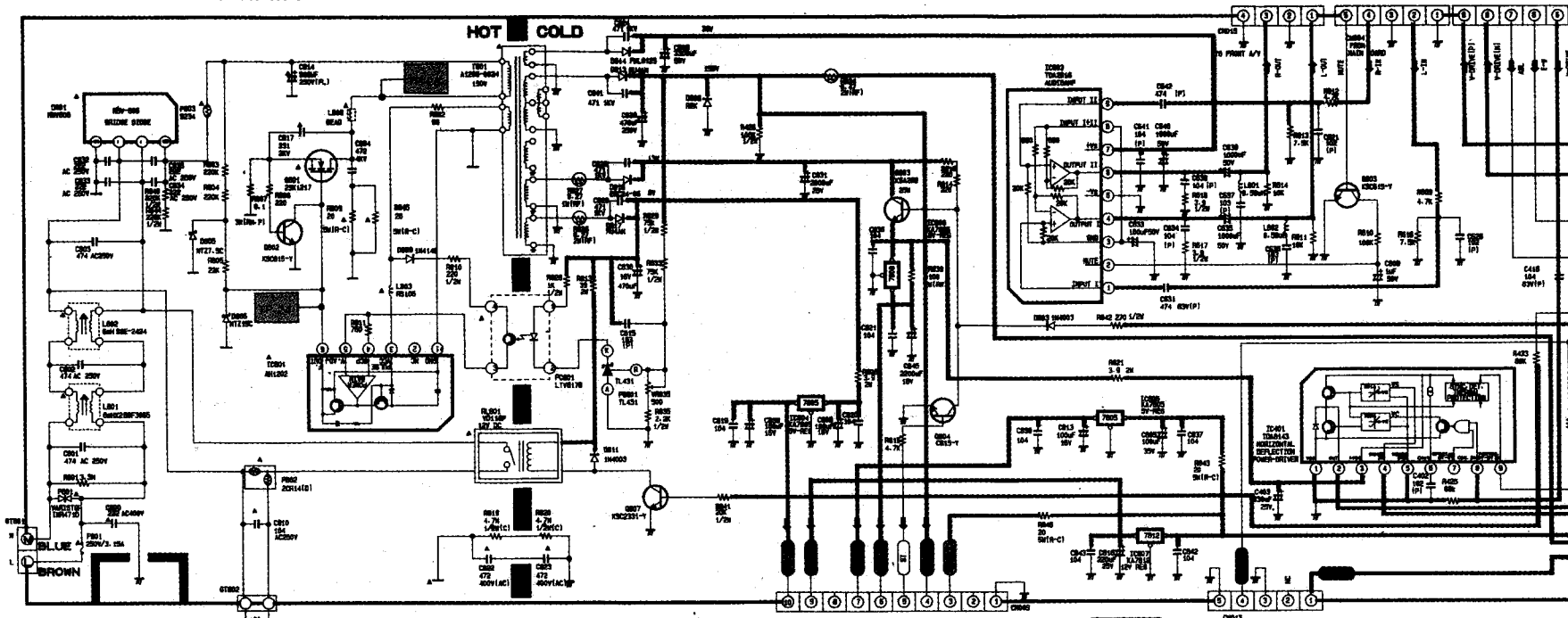

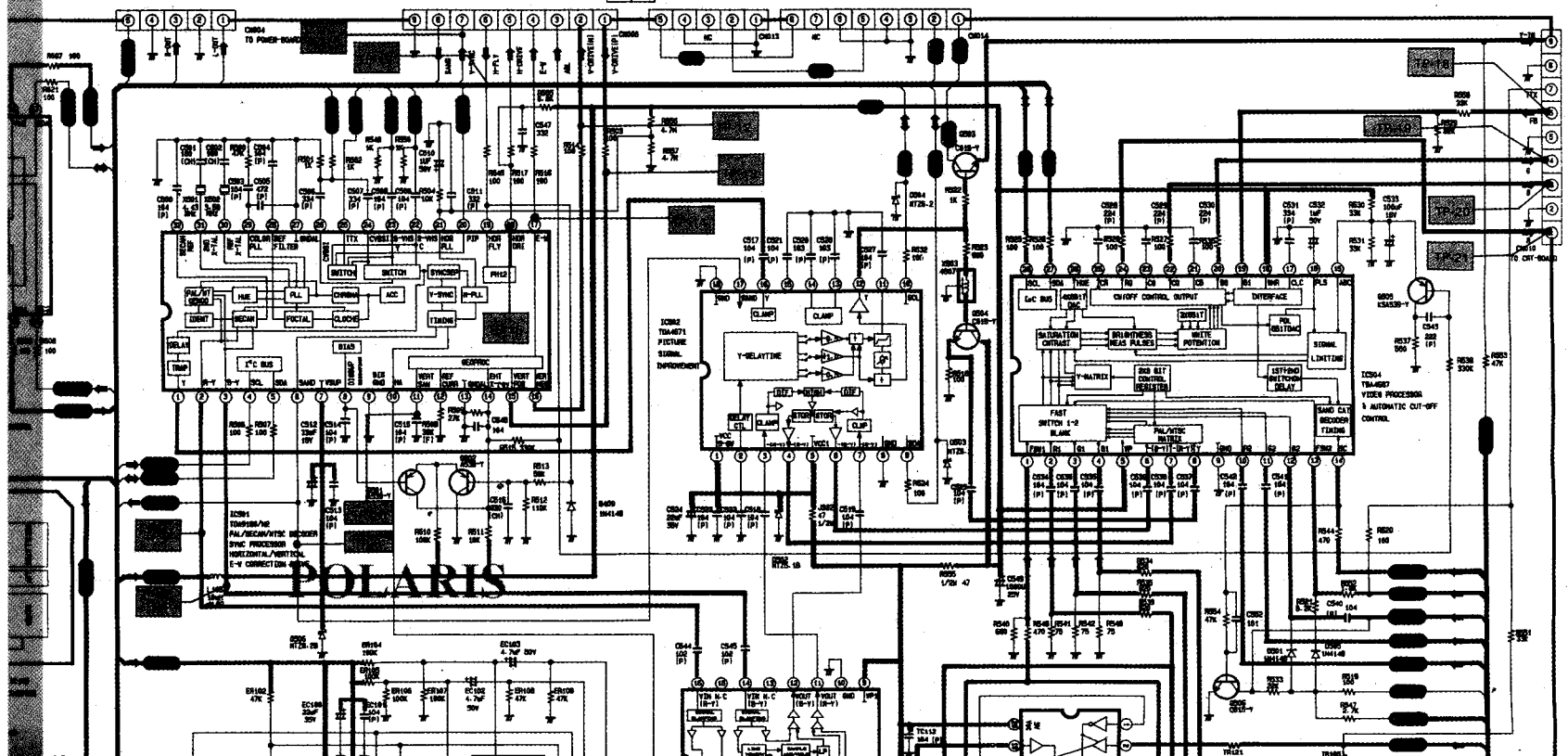
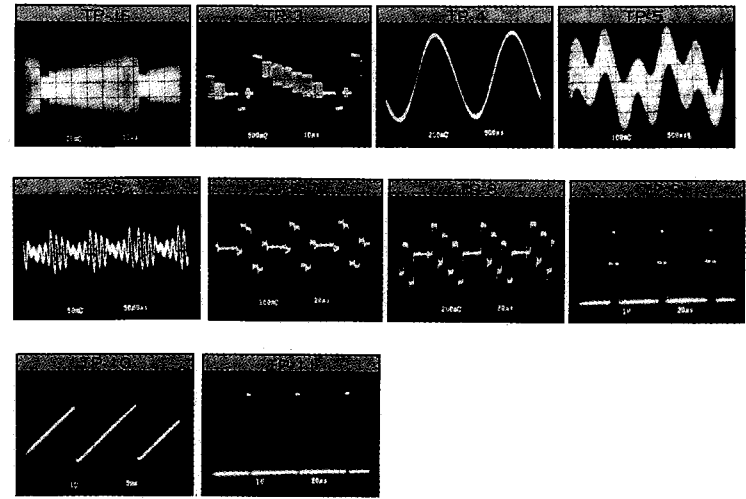
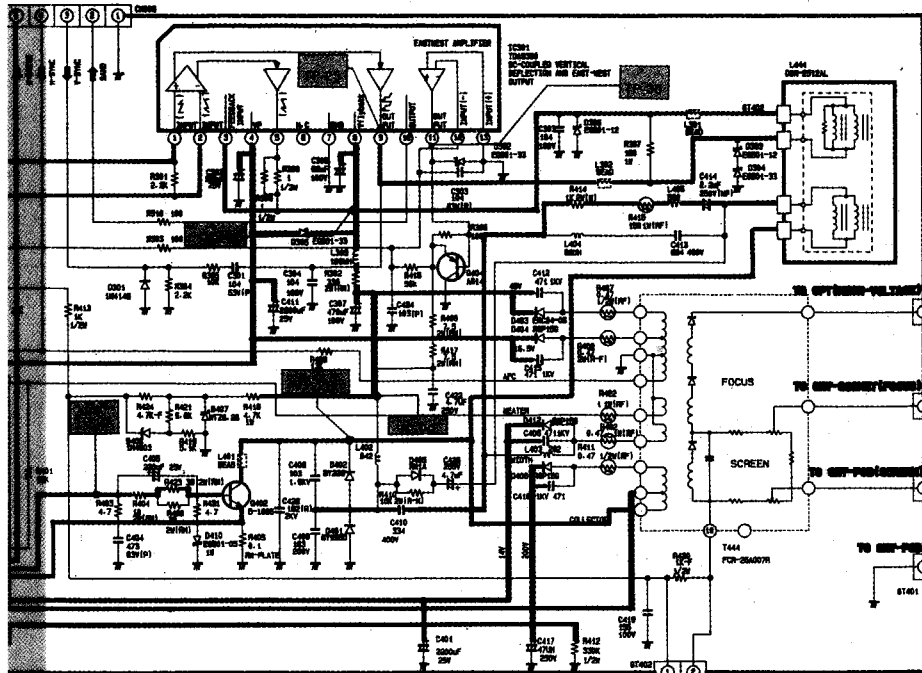

POLARIS

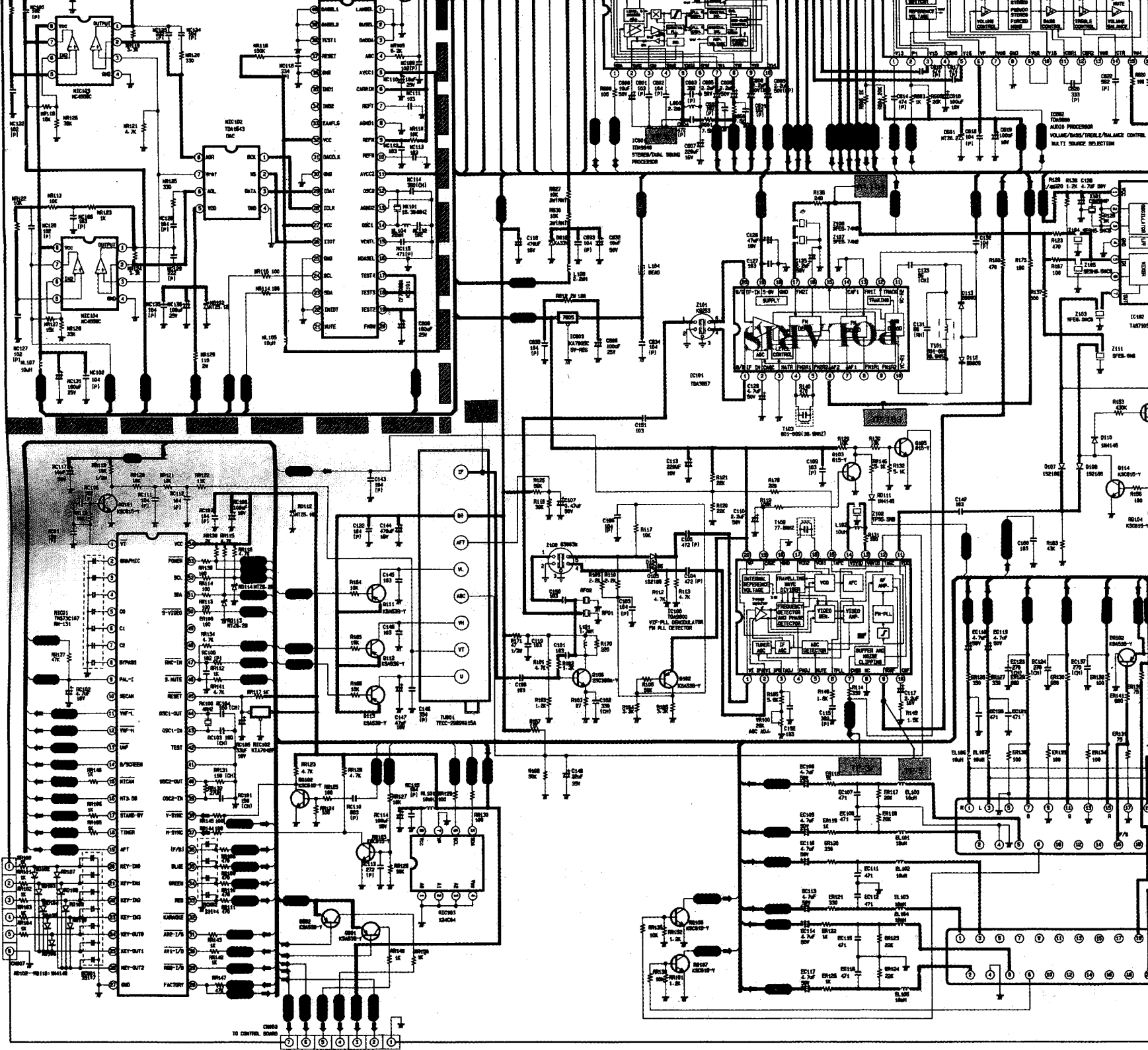

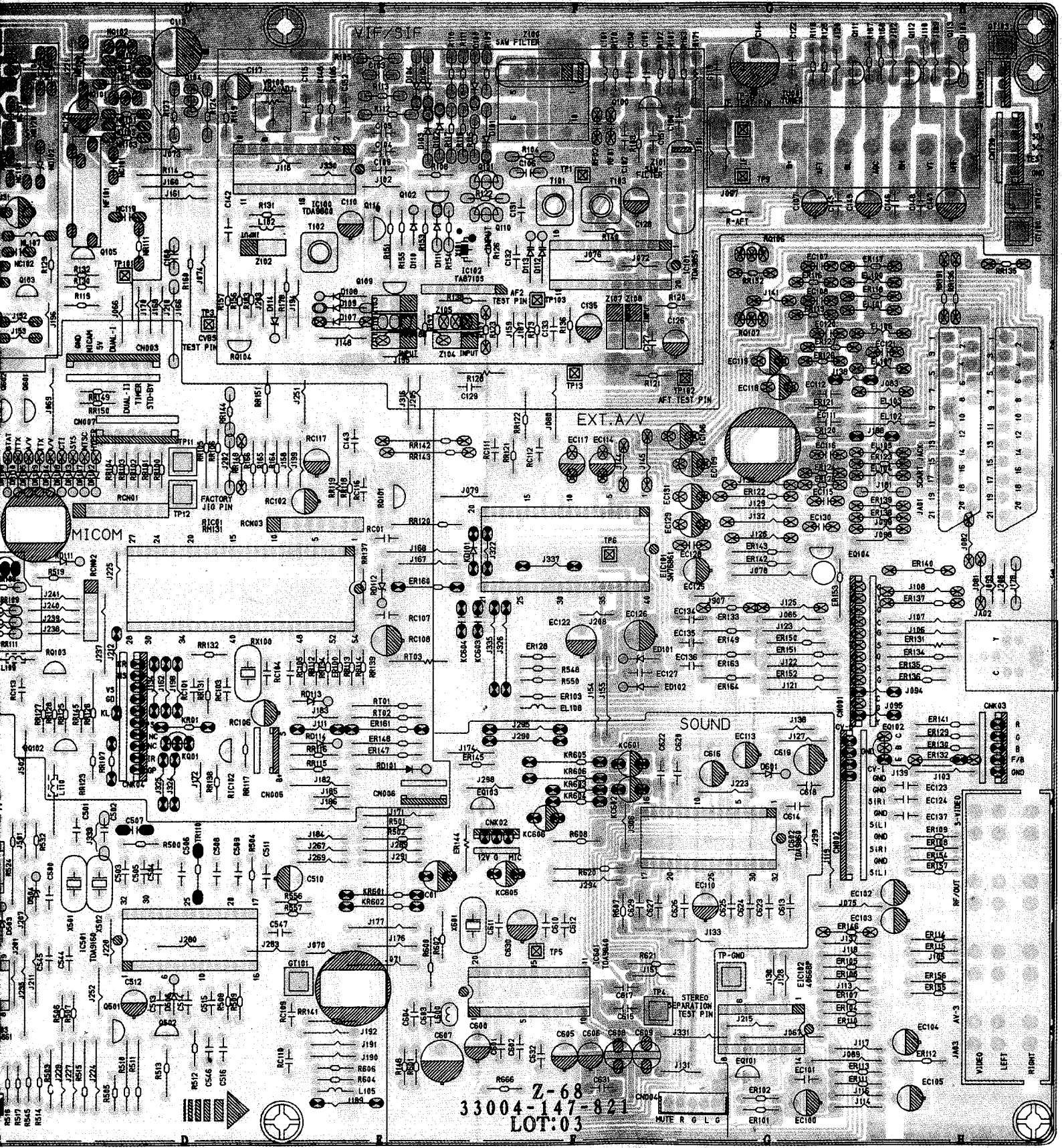

Z-68
33004-147-821
LOT:03

RF OUT

AV-3

VIDEO LEFT RIGHT