

### IGBT Power Module

- Power module
- 3-phase full-bridge
- Including fast free-wheel diodes
- Package with insulated metal base plate

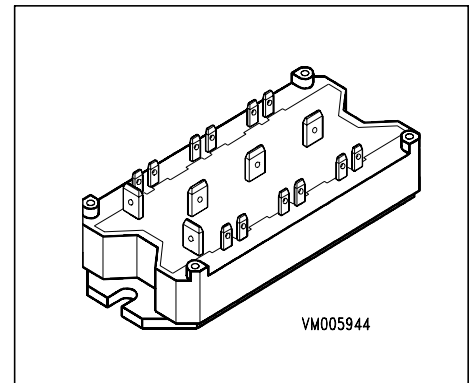

| Type             | $V_{CE}$ | $I_C$ | Package   | Ordering Code    |
|------------------|----------|-------|-----------|------------------|
| BSM 15 GD 120 D2 | 1200V    | 25A   | SIXPACK 1 | C67076-A2504-A17 |

### Maximum Ratings

| Parameter                                      | Symbol      | Values        | Unit             |
|--|-------------|---------------|------------------|
| Collector-emitter voltage                      | $V_{CE}$    | 1200          | V                |
| Collector-gate voltage                         | $V_{CGR}$   | 1200          |                  |
| $R_{GE} = 20 \text{ k}\Omega$                  |             |               |                  |
| Gate-emitter voltage                           | $V_{GE}$    | $\pm 20$      |                  |
| DC collector current                           | $I_C$       |               | A                |
| $T_C = 25 \text{ }^\circ\text{C}$              |             | 25            |                  |
| $T_C = 80 \text{ }^\circ\text{C}$              |             | 15            |                  |
| Pulsed collector current, $t_p = 1 \text{ ms}$ | $I_{Cpuls}$ |               |                  |
| $T_C = 25 \text{ }^\circ\text{C}$              |             | 50            |                  |
| $T_C = 80 \text{ }^\circ\text{C}$              |             | 30            |                  |
| Power dissipation per IGBT                     | $P_{tot}$   |               | W                |
| $T_C = 25 \text{ }^\circ\text{C}$              |             | 145           |                  |
| Chip temperature                               | $T_j$       | + 150         | $^\circ\text{C}$ |
| Storage temperature                            | $T_{stg}$   | -55 ... + 150 |                  |
| Thermal resistance, chip case                  | $R_{thJC}$  | $\leq 0.86$   | K/W              |
| Diode thermal resistance, chip case            | $R_{thJCD}$ | $\leq 1.5$    |                  |
| Insulation test voltage, $t = 1 \text{ min.}$  | $V_{is}$    | 2500          | Vac              |
| Creepage distance                              | -           | 16            | mm               |
| Clearance                                      | -           | 11            |                  |
| DIN humidity category, DIN 40 040              | -           | F             | sec              |
| IEC climatic category, DIN IEC 68-1            | -           | 55 / 150 / 56 |                  |

**Electrical Characteristics**, at  $T_j = 25\text{ °C}$ , unless otherwise specified

| Parameter | Symbol | Values |      |      | Unit |
|-----------|--------|--------|------|------|------|
|           |        | min.   | typ. | max. |      |

**Static Characteristics**

|  |               |        |            |          |    |
|--|---------------|--------|------------|----------|----|
| Gate threshold voltage<br>$V_{GE} = V_{CE}, I_C = 0.6\text{ mA}$   | $V_{GE(th)}$  | 4.5    | 5.5        | 6.5      | V  |
| Collector-emitter saturation voltage<br>$V_{GE} = 15\text{ V}, I_C = 15\text{ A}, T_j = 25\text{ °C}$<br>$V_{GE} = 15\text{ V}, I_C = 15\text{ A}, T_j = 125\text{ °C}$        | $V_{CE(sat)}$ | -<br>- | 2.5<br>3.1 | 3<br>3.7 |    |
| Zero gate voltage collector current<br>$V_{CE} = 1200\text{ V}, V_{GE} = 0\text{ V}, T_j = 25\text{ °C}$<br>$V_{CE} = 1200\text{ V}, V_{GE} = 0\text{ V}, T_j = 125\text{ °C}$ | $I_{CES}$     | -<br>- | 0.3<br>1.2 | 0.5<br>- | mA |
| Gate-emitter leakage current<br>$V_{GE} = 20\text{ V}, V_{CE} = 0\text{ V}$  | $I_{GES}$     | -      | -          | 150      | nA |

**AC Characteristics**

|   |           |     |      |   |    |
|---|-----------|-----|------|---|----|
| Transconductance<br>$V_{CE} = 20\text{ V}, I_C = 15\text{ A}$                                 | $g_{fs}$  | 5.5 | -    | - | S  |
| Input capacitance<br>$V_{CE} = 25\text{ V}, V_{GE} = 0\text{ V}, f = 1\text{ MHz}$            | $C_{iss}$ | -   | 1000 | - | pF |
| Output capacitance<br>$V_{CE} = 25\text{ V}, V_{GE} = 0\text{ V}, f = 1\text{ MHz}$           | $C_{oss}$ | -   | 150  | - |    |
| Reverse transfer capacitance<br>$V_{CE} = 25\text{ V}, V_{GE} = 0\text{ V}, f = 1\text{ MHz}$ | $C_{rss}$ | -   | 70   | - |    |

### Electrical Characteristics, at $T_j = 25\text{ °C}$ , unless otherwise specified

| Parameter | Symbol | Values |      |      | Unit |
|-----------|--------|--------|------|------|------|
|           |        | min.   | typ. | max. |      |

### Switching Characteristics, Inductive Load at $T_j = 125\text{ °C}$

|   |              |   |     |     |    |
|---|--------------|---|-----|-----|----|
| Turn-on delay time<br>$V_{CC} = 600\text{ V}$ , $V_{GE} = 15\text{ V}$ , $I_C = 15\text{ A}$<br>$R_{Gon} = 82\ \Omega$    | $t_{d(on)}$  | - | 55  | 110 | ns |
| Rise time<br>$V_{CC} = 600\text{ V}$ , $V_{GE} = 15\text{ V}$ , $I_C = 15\text{ A}$<br>$R_{Gon} = 82\ \Omega$             | $t_r$        | - | 45  | 90  | nS |
| Turn-off delay time<br>$V_{CC} = 600\text{ V}$ , $V_{GE} = -15\text{ V}$ , $I_C = 15\text{ A}$<br>$R_{Goff} = 82\ \Omega$ | $t_{d(off)}$ | - | 400 | 600 | ns |
| Fall time<br>$V_{CC} = 600\text{ V}$ , $V_{GE} = -15\text{ V}$ , $I_C = 15\text{ A}$<br>$R_{Goff} = 82\ \Omega$           | $t_f$        | - | 70  | 100 |    |

### Free-Wheel Diode

|  |          |   |            |          |               |
|--|----------|---|------------|----------|---------------|
| Diode forward voltage<br>$I_F = 15\text{ A}$ , $V_{GE} = 0\text{ V}$ , $T_j = 25\text{ °C}$<br>$I_F = 15\text{ A}$ , $V_{GE} = 0\text{ V}$ , $T_j = 125\text{ °C}$                       | $V_F$    | - | 2.4<br>1.9 | 2.9<br>- | V             |
| Reverse recovery time<br>$I_F = 15\text{ A}$ , $V_R = -600\text{ V}$ , $V_{GE} = 0\text{ V}$<br>$di_F/dt = -800\text{ A}/\mu\text{s}$ , $T_j = 125\text{ °C}$                            | $t_{rr}$ | - | 0.1        | -        | $\mu\text{s}$ |
| Reverse recovery charge<br>$I_F = 15\text{ A}$ , $V_R = -600\text{ V}$ , $V_{GE} = 0\text{ V}$<br>$di_F/dt = -800\text{ A}/\mu\text{s}$<br>$T_j = 25\text{ °C}$<br>$T_j = 125\text{ °C}$ | $Q_{rr}$ | - | 1<br>3     | -<br>-   | $\mu\text{C}$ |

### Power dissipation

$$P_{\text{tot}} = f(T_C)$$

parameter:  $T_j \leq 150^\circ\text{C}$

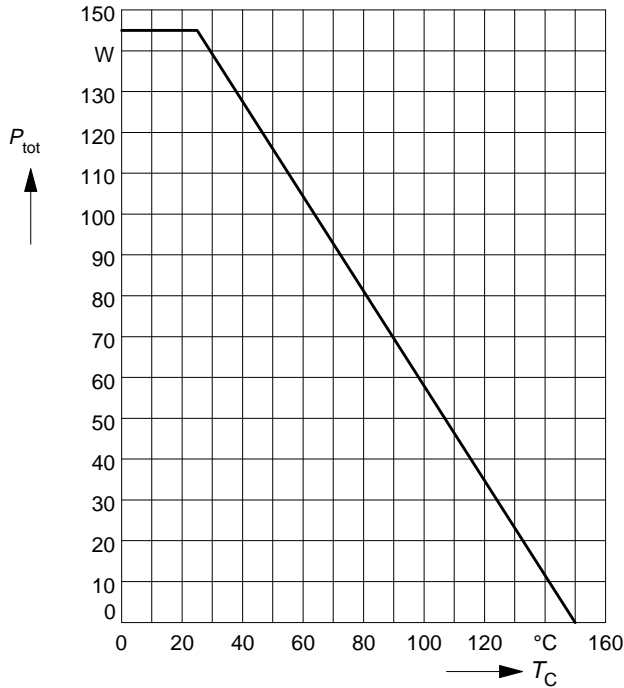

### Safe operating area

$$I_C = f(V_{\text{CE}})$$

parameter:  $D = 0, T_C = 25^\circ\text{C}, T_j \leq 150^\circ\text{C}$

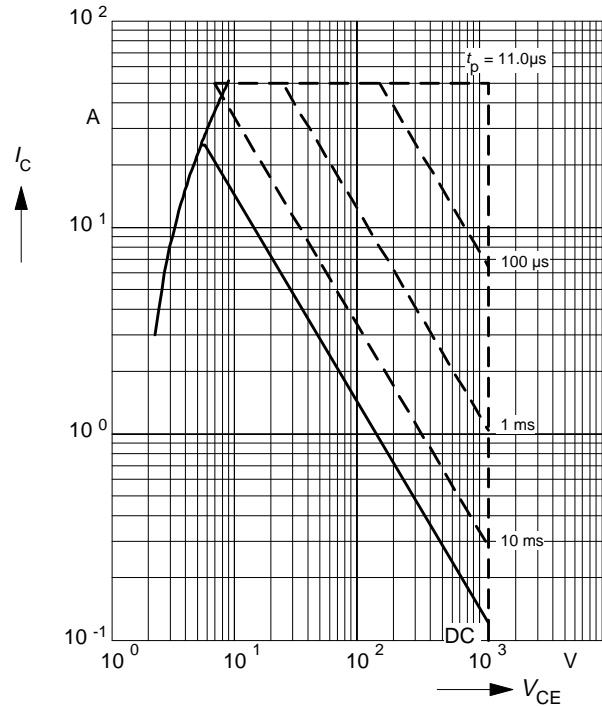

### Collector current

$$I_C = f(T_C)$$

parameter:  $V_{\text{GE}} \geq 15\text{V}, T_j \leq 150^\circ\text{C}$

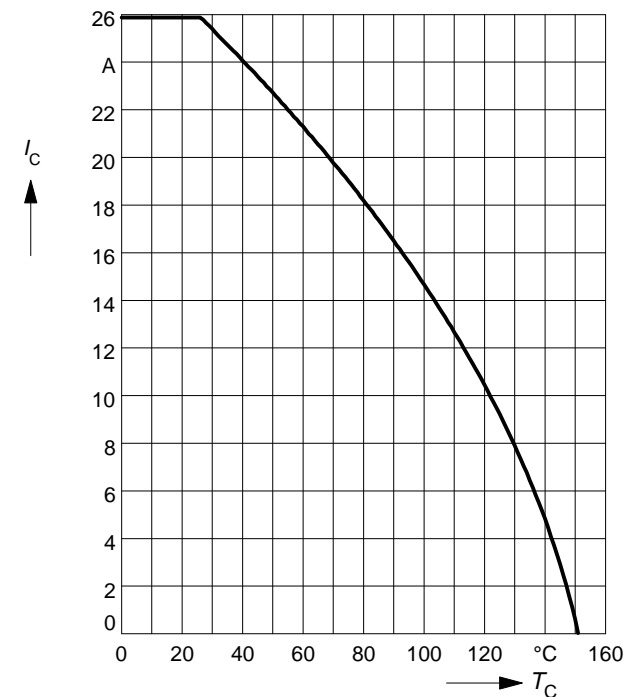

### Transient thermal impedance IGBT

$$Z_{\text{thJC}} = f(t_p)$$

parameter:  $D = t_p / T$

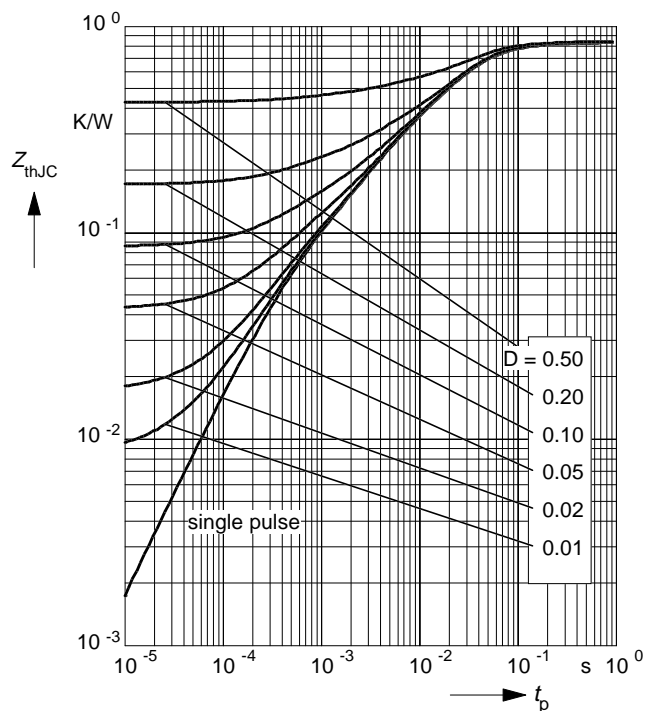

### Typ. output characteristics

$$I_C = f(V_{CE})$$

parameter:  $t_p = 80 \mu s$ ,  $T_j = 25 \text{ }^\circ\text{C}$

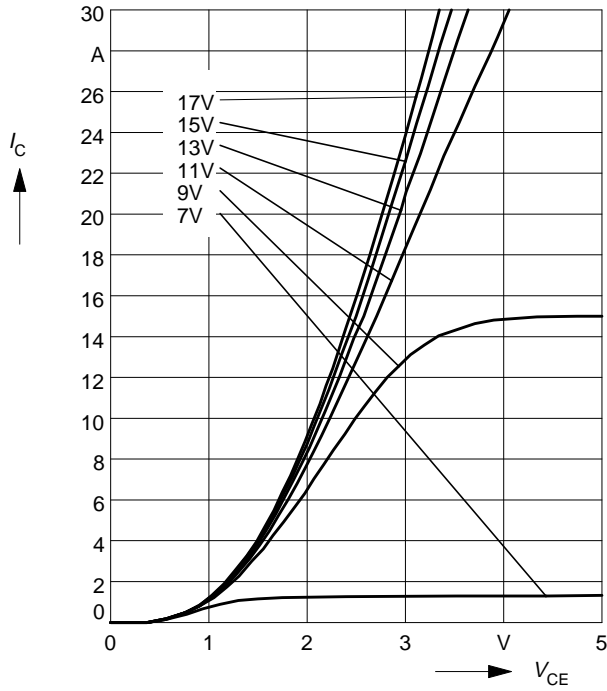

### Typ. output characteristics

$$I_C = f(V_{CE})$$

parameter:  $t_p = 80 \mu s$ ,  $T_j = 125 \text{ }^\circ\text{C}$

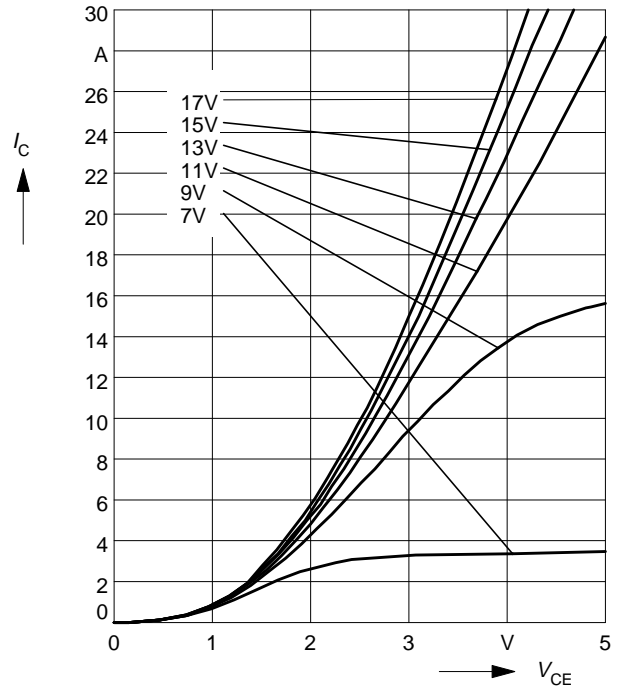

### Typ. transfer characteristics

$$I_C = f(V_{GE})$$

parameter:  $t_p = 80 \mu s$ ,  $V_{CE} = 20 \text{ V}$

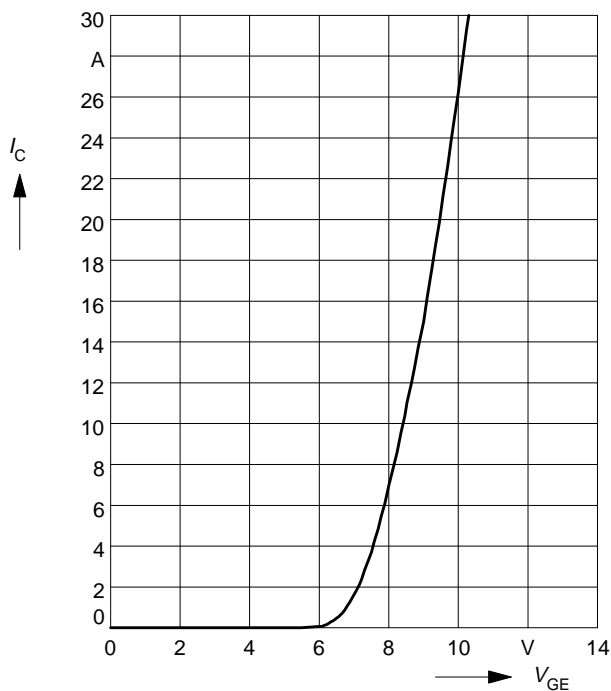

### Typ. gate charge

$$V_{GE} = f(Q_{Gate})$$

parameter:  $I_{C\ puls} = 15\ A$

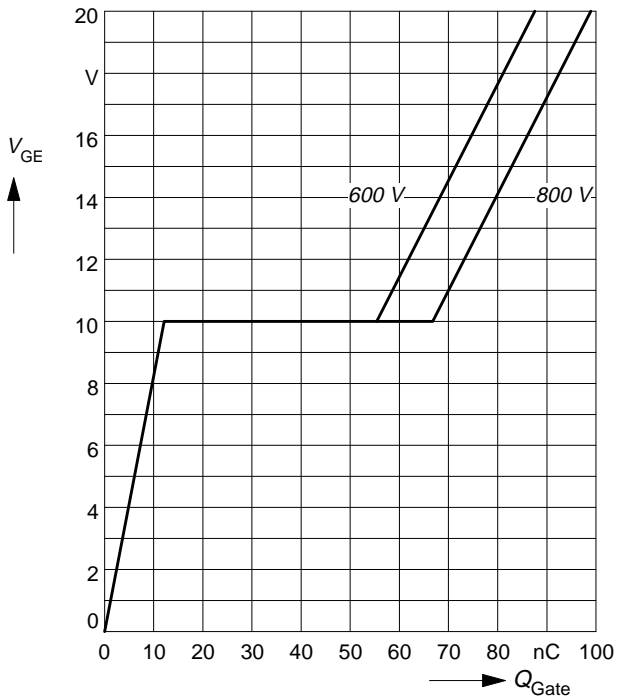

### Typ. capacitances

$$C = f(V_{CE})$$

parameter:  $V_{GE} = 0\ V, f = 1\ MHz$

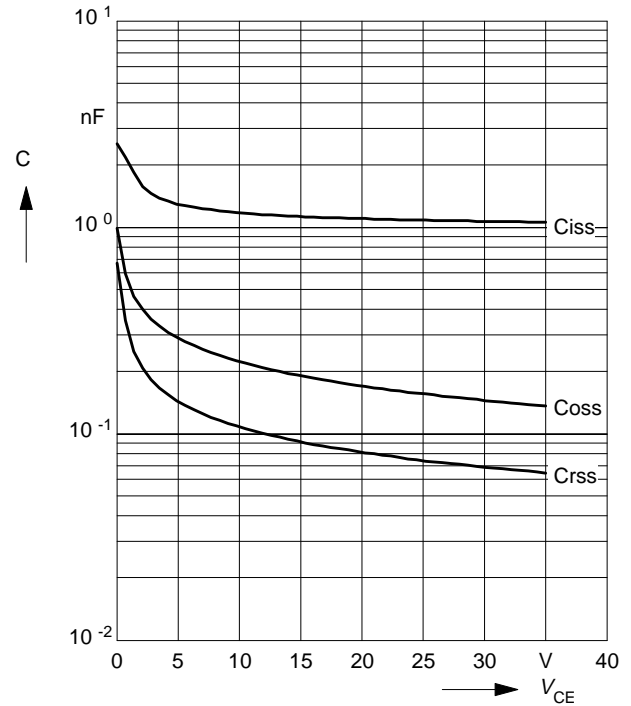

### Reverse biased safe operating area

$$I_{C\ puls} = f(V_{CE}), T_j = 150^\circ C$$

parameter:  $V_{GE} = 15\ V$



### Short circuit safe operating area

$$I_{C\ sc} = f(V_{CE}), T_j = 150^\circ C$$

parameter:  $V_{GE} = \pm 15\ V, t_{SC} \le 10\ \mu s, L < 50\ nH$

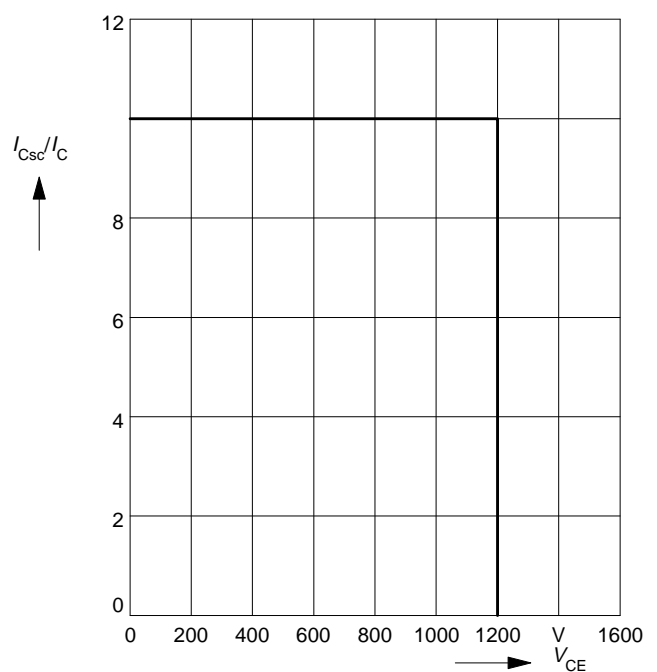

### Typ. switching time

$t = f(I_C)$ , inductive load,  $T_j = 125^\circ\text{C}$   
 par.:  $V_{CE} = 600\text{ V}$ ,  $V_{GE} = \pm 15\text{ V}$ ,  $R_G = 82\ \Omega$

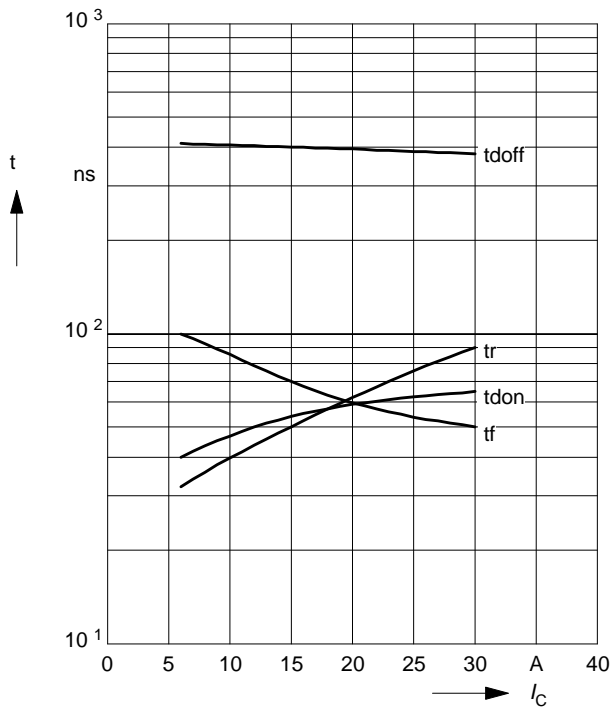

### Typ. switching time

$t = f(R_G)$ , inductive load,  $T_j = 125^\circ\text{C}$   
 par.:  $V_{CE} = 600\text{ V}$ ,  $V_{GE} = \pm 15\text{ V}$ ,  $I_C = 15\text{ A}$

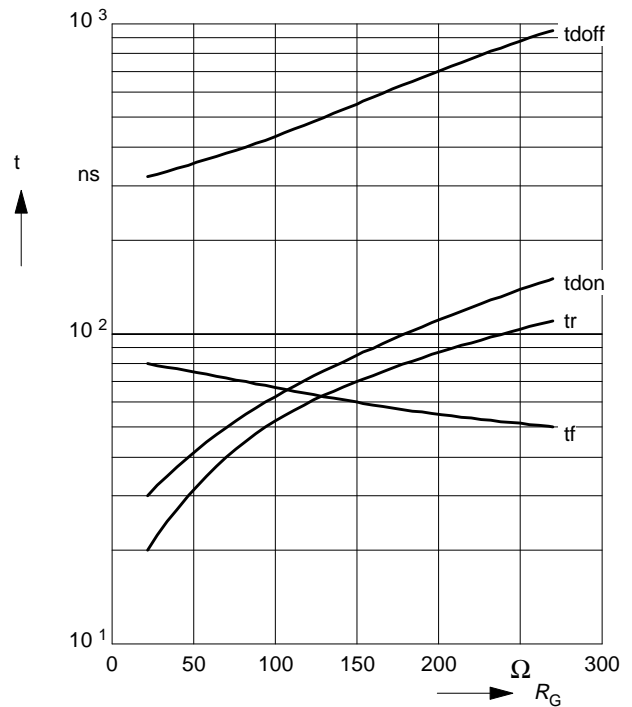

### Typ. switching losses

$E = f(I_C)$ , inductive load,  $T_j = 125^\circ\text{C}$   
 par.:  $V_{CE} = 600\text{ V}$ ,  $V_{GE} = \pm 15\text{ V}$ ,  $R_G = 82\ \Omega$

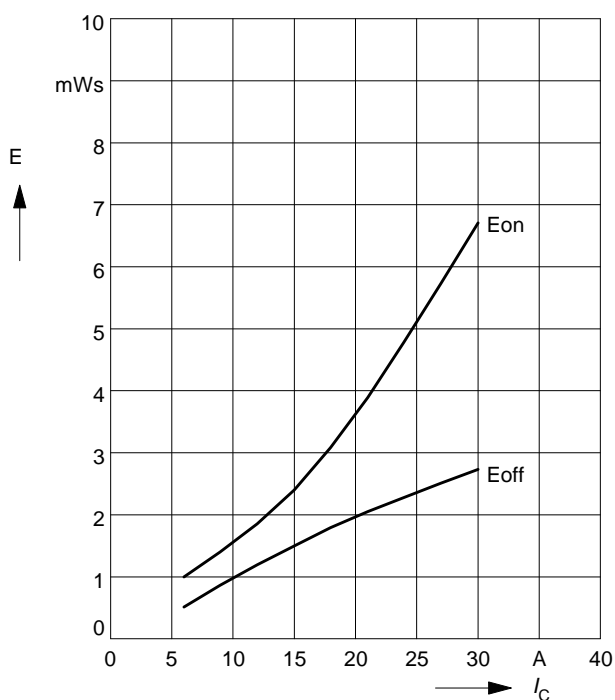

### Typ. switching losses

$E = f(R_G)$ , inductive load,  $T_j = 125^\circ\text{C}$   
 par.:  $V_{CE} = 600\text{ V}$ ,  $V_{GE} = \pm 15\text{ V}$ ,  $I_C = 15\text{ A}$

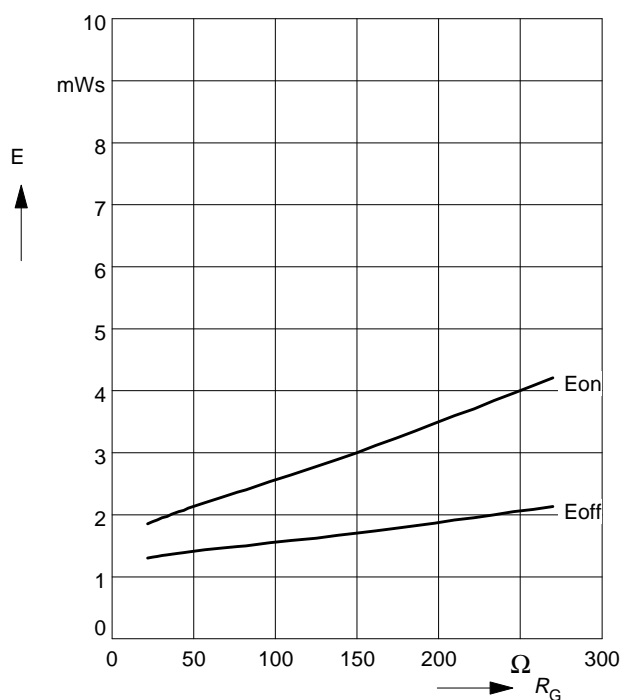

### Forward characteristics of fast recovery reverse diode

$I_F = f(V_F)$

parameter:  $T_j$

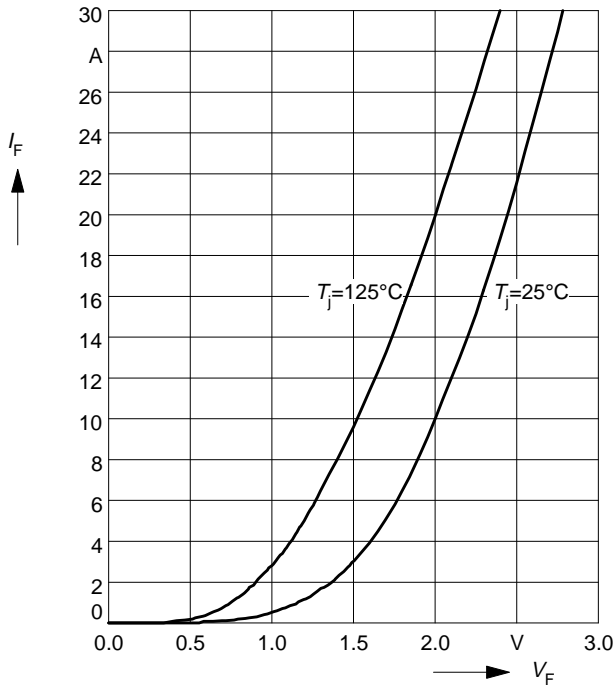

### Transient thermal impedance Diode

$$Z_{thJC} = f(t_p)$$

parameter:  $D = t_p / T$

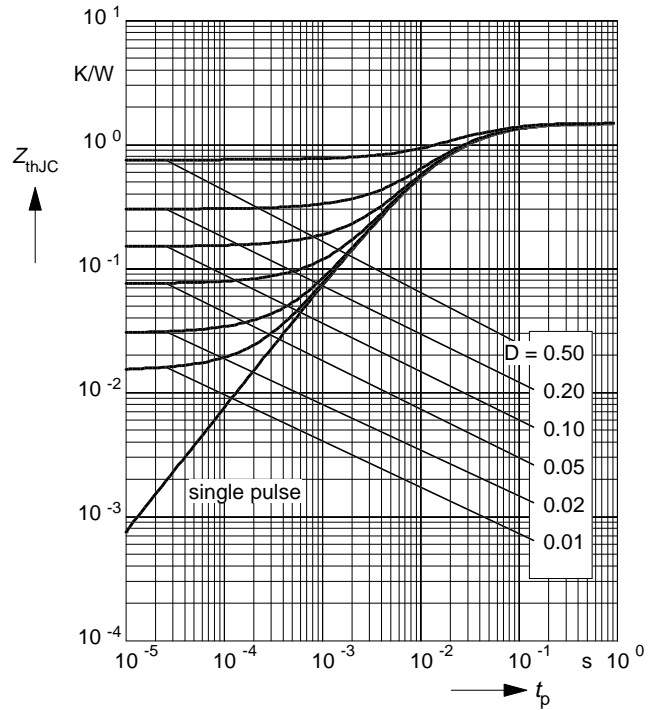



### Circuit Diagram

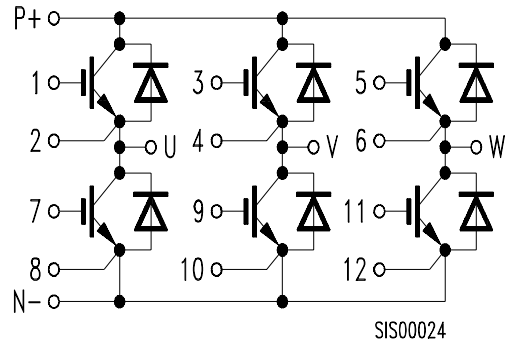

### Package Outlines

Dimensions in mm

Weight: 190 g

