

Powerex, Inc. Hillis Street, Youngwood, Pennsylvania 15697 (412) 925-7272  
 Powerex Europe, S.A., 428 Ave. G. Durand, BP107, 72003 LeMans, France (43) 72.75.15

### Phase Control SCR 450-600 Amperes Avg 500-1800 Volts

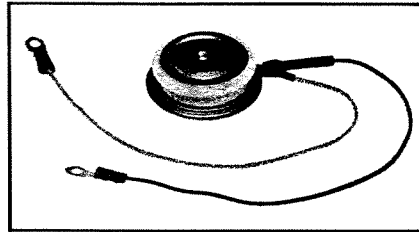
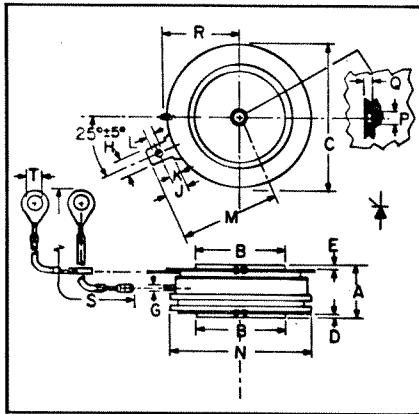

**C431**  
**Phase Control SCR**  
 450-600 Amperes/500-1800 Volts

#### C431 Outline Drawing

Dimensions	Inches		Millimeters	
	Min.	Max.	Min.	Max.
A	.560	.605	14.22	15.37
B	.985	.995	25.01	25.27
C	1.600	1.650	40.64	41.91
D	.030	—	.76	—
E	.040	—	1.01	—
G	.057	.059	1.44	1.50
H	.186	.191	4.72	4.85
J	.245	.255	6.22	6.48
K	.115	.130	2.92	3.30
L	.064	.070	1.62	1.78
M	—	1.120	—	28.45
N	—	1.585	—	40.26
P	.135	.145	3.42	3.68
Q	.070	.084	1.77	2.13
R	—	.875	—	22.23
S	12.219	12.343	310.36	313.51
T	.137	.153	3.47	3.89

#### Description

Powerex Silicon Controlled Rectifiers (SCR) are designed for phase control applications. These are all-diffused, Press-Pak (Pow-R-Disc) devices employing the field-proven amplifying (di/namic) gate.

#### Features:

- Low On-State Voltage
- High di/dt
- High dv/dt
- Hermetic Packaging
- Excellent Surge and I<sup>2</sup>t Ratings

#### Applications:

- Power Supplies
- Battery Chargers
- Motor Control
- Light Dimmers
- VAR Generators

#### Ordering Information

Example: Select the complete six or seven digit part number you desire from the table - i.e. C431T1 is a 900 Volt, 600 Ampere Phase Control SCR.

Type	Voltage		Current	
	V <sub>ONM</sub> V <sub>RRM</sub>	Code	I <sub>T</sub> (avg)	Code
C431	500	E	450	2
	600	M		
	700	S	600	1
	800	N		
	900	T		
	1000	P		
	1100	PA		
	1200	PB		
	1300	PC		
	1400	PD		
1500	PE			
1600	PM			



Powerex, Inc., Hillis Street, Youngwood, Pennsylvania 15697 (412) 925-7272  
 Powerex Europe, S.A., 428 Ave. G. Durand, BP107, 72003 LeMans, France (43) 72.75.15

**C431**  
**Phase Control SCR**  
 450-600 Amperes Avg/500-1800 Volts

**Absolute Maximum Ratings**

	Symbol	C431__1	C431__2	Units
RMS On-State Current	$I_{T(RMS)}$	950	700	Amperes
Average On-State Current	$I_{T(av)}$	600	450	Amperes
Peak One-Cycle Surge (Non Repetitive) On-State Current (60Hz)	$I_{TSM}$	8000	6500	Amperes
Peak One-Cycle Surge (Non-Repetitive) On-State Current (50Hz)	$I_{TSM}$	7300	5950	Amperes
Critical Rate-of-Rise of On-State Current (Non-Repetitive)	di/dt	150	150	Amperes/ $\mu$ s
Critical Rate-of-Rise of On-State Current (Repetitive)	di/dt	100	100	Amperes/ $\mu$ s
$I^2t$ (for Fusing), One Cycle at 60Hz	$I^2t$	$2.678 \times 10^5$	$1.76 \times 10^5$	A <sup>2</sup> sec
Peak Gate Power Dissipation	$P_{GM}$	200	200	Watts
Average Gate Power Dissipation	$P_{G(av)}$	5	5	Watts
Storage Temperature	$T_{STG}$	-40 to 150	-40 to 150	°C
Operating Temperature	$T_J$	-40 to 125	-40 to 125	°C
Mounting Force <sup>ⓐ</sup>		800-2500	800-2500	lb.
Mounting Force <sup>ⓐ</sup>		3.6-11.1	3.6-11.1	kN

<sup>ⓐ</sup> Consult recommended mounting procedures.

**C431**

**Phase Control SCR**

450-600 Amperes Avg/500-1800 Volts

**Electrical and Thermal Characteristics**

	Symbol	Test Conditions	C431_1	C431_2	Units
<b>Current—Conducting State Maximums</b>					
Peak On-State Voltage	$V_{TM}$	$I_{TM} = 3000A$ Peak, $T_J = 25^\circ C$ , Duty Cycle $\leq 0.01\%$	2.62	3.6	Volts
<b>Voltage—Blocking State Maximums</b>					
Forward Leakage, Peak	$I_{DRM}$	$T_J = 125^\circ C$ , $V = V_{DRM}$	45	60	mA
Reverse Leakage, Peak	$I_{RRM}$	$T_J = 125^\circ C$ , $V = V_{RRM}$	45	60	mA
<b>Switching</b>					
Typical Turn-Off Time	$t_q$	$T_J = 125^\circ C$ , $I_{TM} = 500A$ ; $V_R = 50V$ Min; $V_{DRM}$ (Reapplied); $dv/dt = 20V/\mu sec$ (linear); Commutation $di/dt = 25A/\mu sec$ ; Repetition Rate = 1pps; Gate Bias during Turn-Off Interval = 0V, $100\Omega$	200	75	$\mu sec$
			<b>C431</b>		
Typical Delay Time	$t_d$	$T_J = 25^\circ C$ , $I_T = 50A$ , Gate Supply: 20V, $20\Omega$ , 0.1 $\mu sec$ rise time	.7		$\mu sec$
Min. Critical $dv/dt$ exponential to $V_{DRM}$	$dv/dt$	$T_J = 125^\circ C$ , $V_{DRM} = .8$ Rated, Gate Open	200		V/ $\mu sec$
<b>Thermal and Mechanical</b>					
Maximum Thermal Resistance, <sup>Ⓞ</sup> double sided cooling					
Junction to Case (2000 lb force)	$R_{\theta JC}$		.045		$^\circ C/Watt$
Case to Sink, Lubricated (2000 lb force)	$R_{\theta CS}$		.02		$^\circ C/Watt$
<b>Gate—Maximum Parameters</b>					
Gate Current to Trigger	$I_{GT}$	$V_D = 6Vdc$ , $T_J = 25^\circ C$ , $R_L = 3\Omega$	150		mA
Gate Voltage to Trigger	$V_{GT}$	$T_J = -40$ to $125^\circ C$ , $V_D = 6Vdc$ , $R_L = 3\Omega$	5		Volts
Non-Triggering Gate Voltage	$V_{GDM}$	$T_J = 125^\circ C$ , Rated $V_{DRM}$ , $R_L = 1000\Omega$	.15		Volts
Peak Forward Gate Current	$I_{GTM}$		10		Amperes
Peak Reverse Gate Voltage	$V_{GRM}$		5		Volts

Ⓞ Consult recommended mounting procedures.

Powerex, Inc., Hillis Street, Youngwood, Pennsylvania 15697 (412) 925-7272  
 Powerex Europe, S.A., 428 Ave. G. Durand, BP107, 72003 LeMans, France (43) 72.75.15

**C431**  
 Phase Control SCR  
 450-600 Amperes Avg/500-1800 Volts

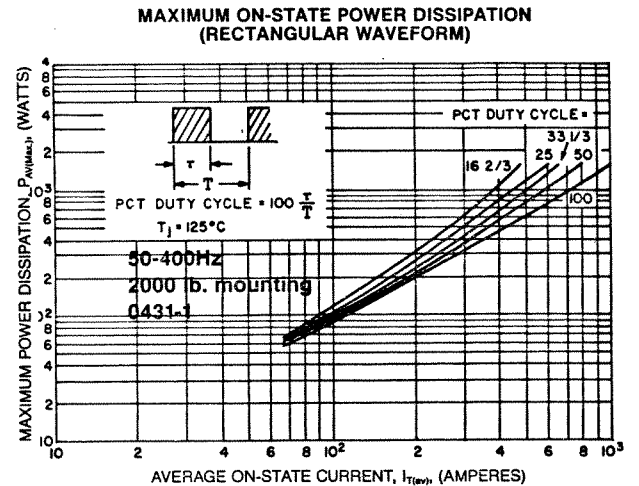
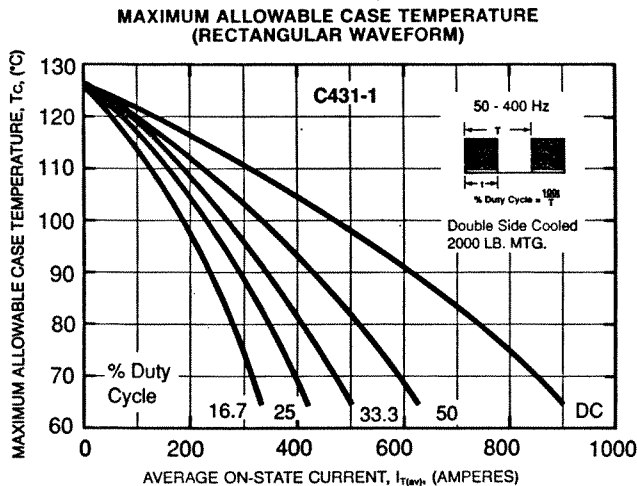
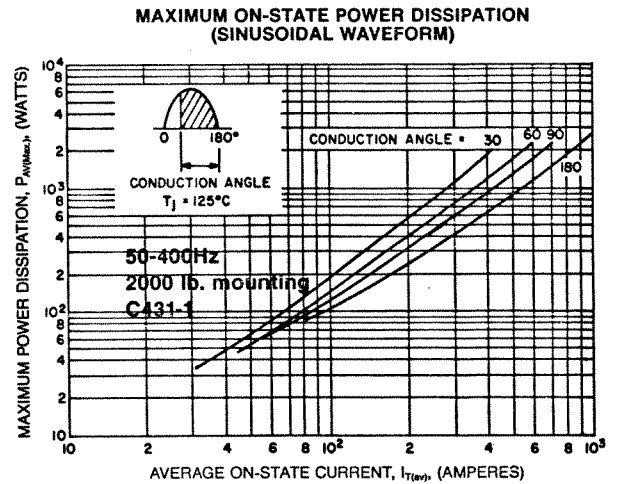
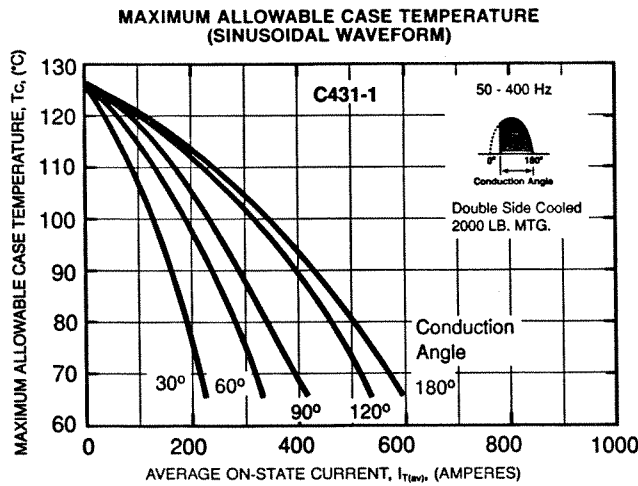
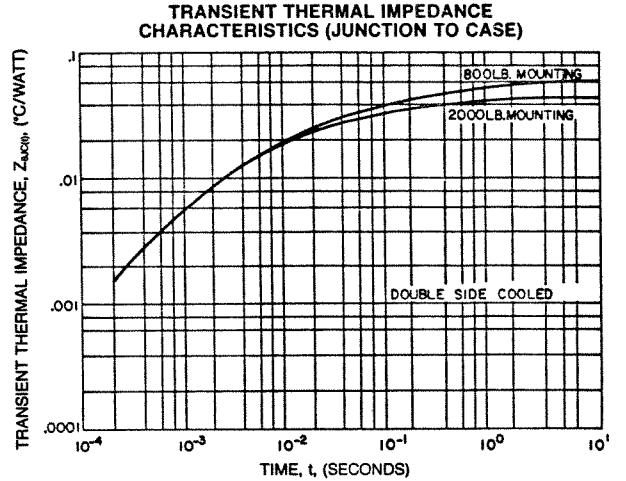
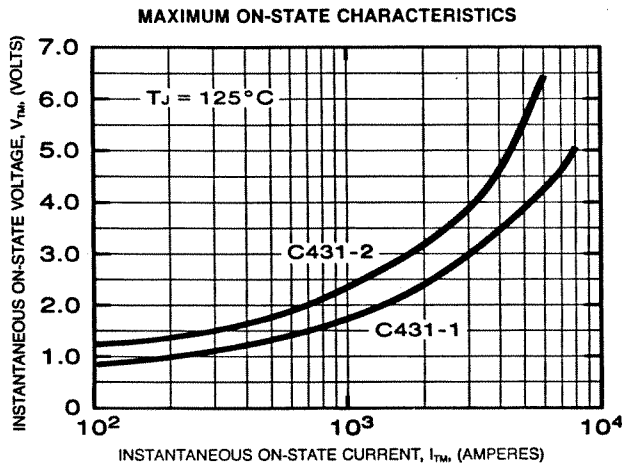

Powerex, Inc., Hillis Street, Youngwood, Pennsylvania 15697 (412) 925-7272  
 Powerex Europe, S.A., 428 Ave. G. Durand, BP107, 72003 LeMans, France (43) 72.75.15

**C431**  
**Phase Control SCR**  
 450-600 Amperes Avg/500-1800 Volts

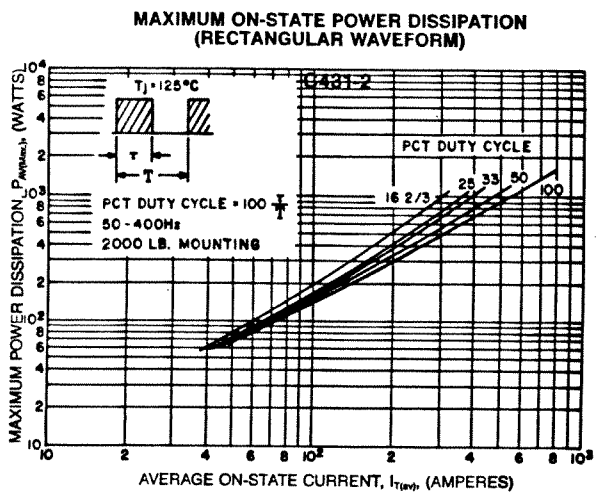
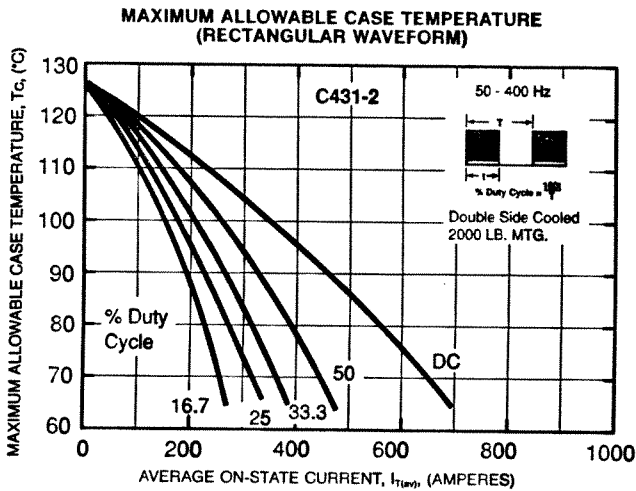
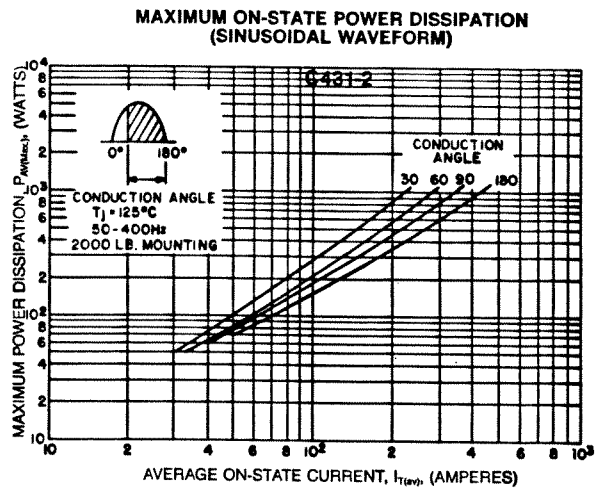
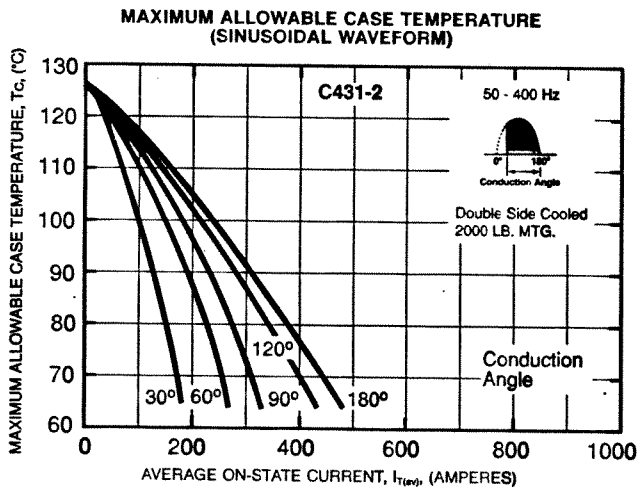
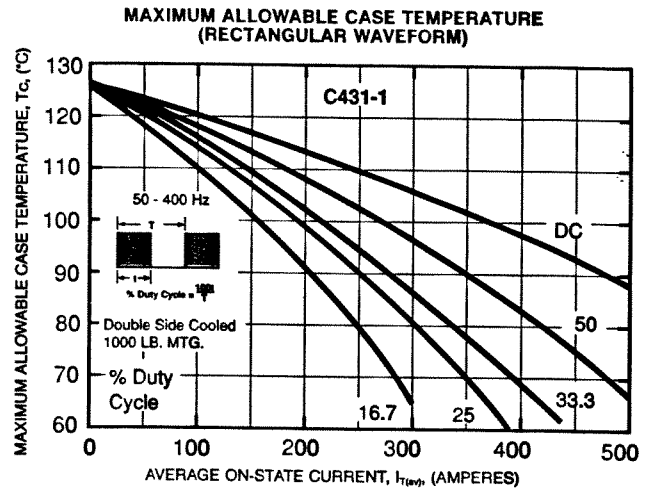
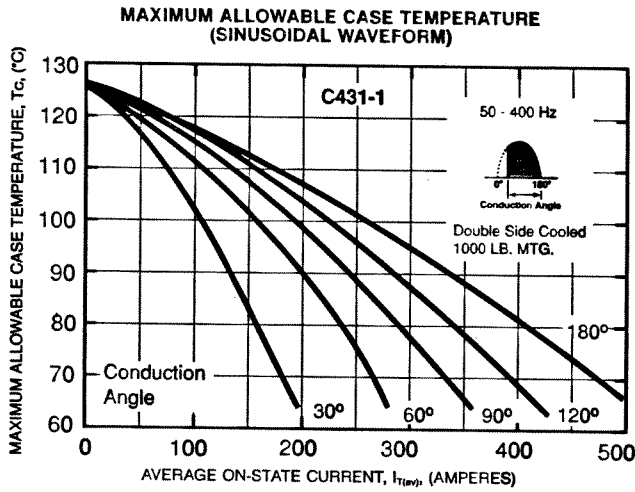

Powerex, Inc., Hillis Street, Youngwood, Pennsylvania 15697 (412) 925-7272

Powerex Europe, S.A., 428 Ave. G. Durand, BP107, 72003 LeMans, France (43) 72.75.15

## C431

### Phase Control SCR

450-600 Amperes Avg/500-1800 Volts

MAXIMUM ALLOWABLE CASE TEMPERATURE (SINUSOIDAL WAVEFORM)

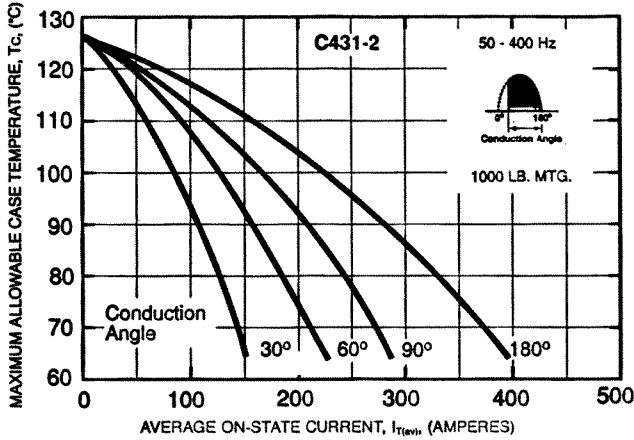

MAXIMUM ALLOWABLE CASE TEMPERATURE (RECTANGULAR WAVEFORM)

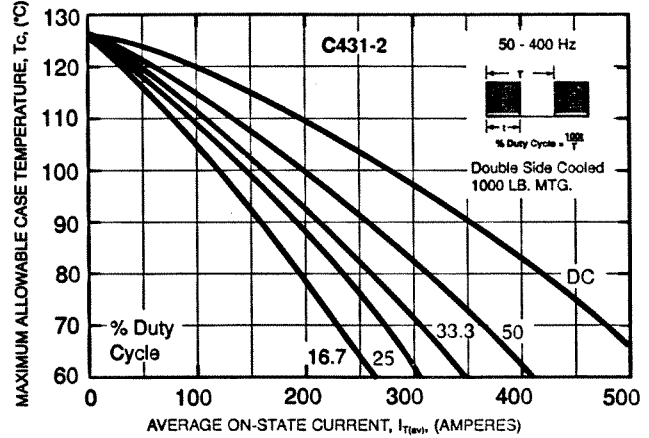

SUB-CYCLE SURGE AND  $I^2t$  RATINGS (RATED LOAD CONDITIONS)

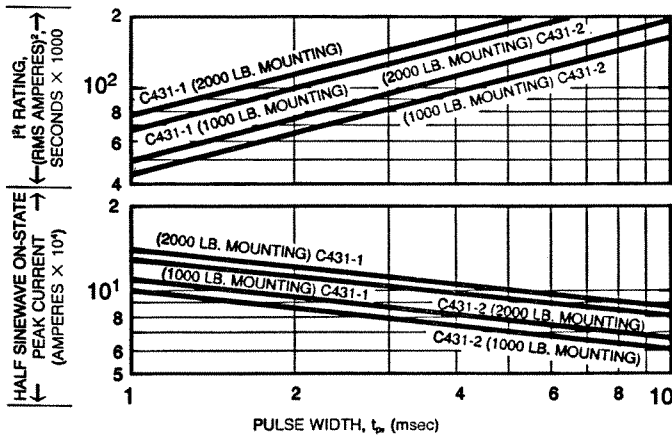

MAXIMUM RECOVERED CHARGE

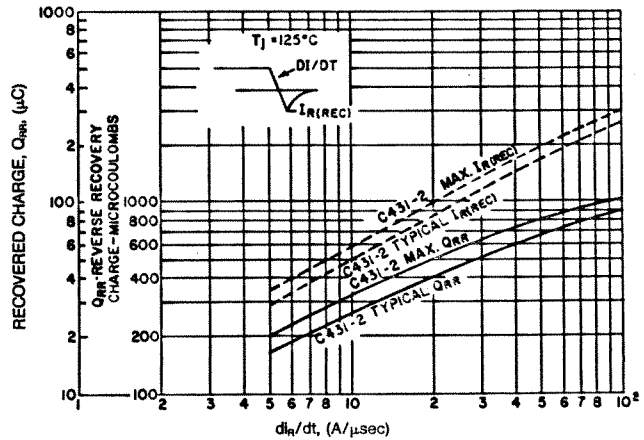

GATE CHARACTERISTICS

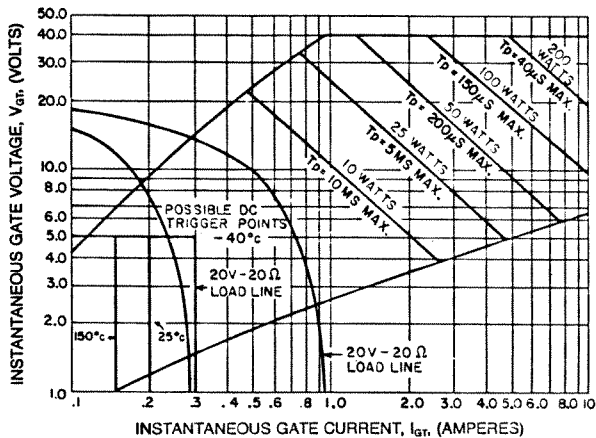

#### NOTES:

- Maximum allowable average gate dissipation = 5 watts.
- The locus of possible dc trigger points lie outside the boundaries shown at various case temperatures.
- $T_p$  = Rectangular gate current pulse width (5 $\mu$ s min. duration; 1.0 $\mu$ s max. rise time for 20V, 65 $\Omega$  source).
- 20V - 20 $\Omega$  is the minimum gate source load line when rate of circuit current rise > 100 Amp/ $\mu$ s or anode rate of current rise > 200 Amps/ $\mu$ s ( $T_p = 5\mu$ s min., 0.5 $\mu$ s max. rise time).

Maximum long-term repetitive anode  $dI/dt = 500$  Amps/ $\mu$ s with 20V - 20 $\Omega$  gate source.