

Absolute Maximum Ratings

Parameter	Symbol	Limits	Unit
Input voltage	V_i	190	V
Operating temperature range	T_{opr}	-20 to +80	°C
Storage temperature range	T_{stg}	-20 to +105	°C
Maximum surface temperature	T_{cmax}	105	°C
ESD endurance	V_{surge}	2	kV
Maximum output current	I_{oMAX}	160	mA

Electrical Characteristics

Parameter	Symbol	Min.	Typ.	Max.	Unit	Conditions
Input voltage	V_i	113	141	190	V	DC(80 to 134VAC)
Output voltage1	V_{o1}	3.7	4.3	4.6	V	$V_i=113V, I_{o1}=1mA$
Output current1	I_{o1}	—	—	1.0	mA	$V_i=113V$
Output voltage2	V_{o2}	19.3	20.4	21.5	V	
Output current2	I_{o2}	—	—	160	mA	
Line regulation	V_{r2}	—	0.05	0.15	V	$V_i=113$ to 190V * 1
Load regulation	V_{l2}	—	0.07	0.20	V	$I_{o}=0$ to 100mA * 2
Output ripple voltage	V_{p2}	—	0.05	0.151	Vp-p	* 3
Control OFF voltage	$V_{ctl(H)}$	2.0	—	0.0	V	Open collector input, V_{o2} : OFF
Control ON voltage	$V_{ctl(L)}$	—	—	0.6	V	Open collector input, V_{o2} : ON
Output voltage when OFF	$V_{o(off)}$	—	0	0.01	V	$V_{ctl}=5V$
Power conversion efficiency	η	78	82	—	%	$V_i=141V, I_{o2}=160mA$ * 4

- * 1 Fluctuating value of output voltage for fluctuation of input voltage.
- * 2 Fluctuating value of output voltage for fluctuation of output current.
- * 3 Measured at PEAK-TO-PEAK and BAND-WIDTH:20MHz of ripple current, and spike noise is not included.
- * 4 $\eta = \frac{V_{o2} \times I_{o2}}{V_{in} \times I_{in}} \times 100[\%]$

Application circuit

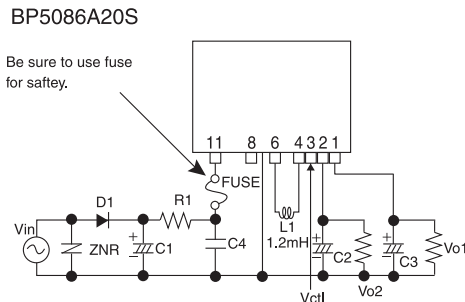

Pin No.	Function
1	Output1 Vo(4V)
2	Output2 Vo(20V)
3	20V Output control terminal
4	Choke coil connect
5	Not used
6	Choke coil connect
7	Not used
8	COMMON
9	Not used
10	Not used
11	Input terminal Vi(141VDC)

For actual usage, Please kindly evaluate and confirm our part mounted in your product, Especially, Please make sure to confirm the load current does not exceed Max. rated current by using the current probe.

External components setting

- FUSE:** Fuse Please make sure to use quick acting fuse 1A
- C1:** Capacitor for input voltage smoothing Capacitance : 22 μ F to 47 μ F Rated voltage : 200V or higher Ripple current is 0.19Arms above.
- C2:** Capacitor for output voltage smoothing Capacitance : 100 μ F to 470 μ F Rated voltage : 50V or higher, ESR is 0.4 Ω max. Ripple current is 0.41Arms above. Output ripple voltage is influenced. Please evaluate it in the actual set.
- C3:** Capacitor for input voltage smoothing Capacitance : 1 μ F to 4.7 μ F Rated voltage : 10V or higher
- C4:** For noise terminal voltage reduction Capacitance : 0.1 μ F to 0.22 μ F Rated voltage : 200V or higher Film capacitor or ceramic capacitor. Reduce the noise terminal voltage. The constant value should be evaluated in the set.
- L1:** Choke coil L : 1.2mH Allowable current : 0.41A or higher Please use the one that is hard to be magnetic saturated even in the high temperature.
- D1:** Rectifier diode In the absolute maximum ratings, the reverse peak voltage should be 400V or higher, the average rectifying current should be 0.5A or higher, and the peak surge current should be 20A or higher. (Full-wave rectifier can be used in our part.)
- R1:** For noise terminal voltage reduction 10 to 22 1/4W Reduce the noise terminal voltage. Please set it, if necessary. The constant value should be evaluated in set.
- ZNR:** Varistor Varistor must be used. It protects this part from lightning surge and static electricity.

Dimension (Unit : mm)

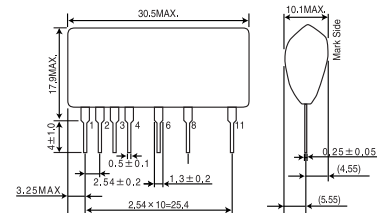

Derating Curve

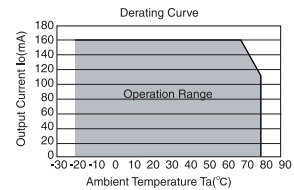

Switching Frequency

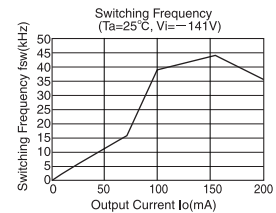

Conversion Efficiency

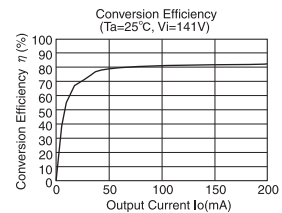

Load Regulation

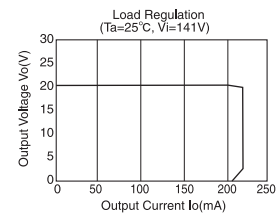

Surface Temperature Rising

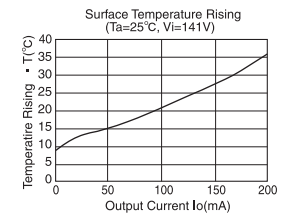

Precautions on Use of ROHM Power Module

Safety Precautions

- 1) The products are designed and produced for application in ordinary electronic equipment (AV equipment, OA equipment, telecommunication equipment, home appliances, amusement equipment etc.).
If the products are to be used in devices requiring extremely high reliability (medical equipment, transport equipment, aircraft/spacecraft, nuclear power controllers, fuel controllers, car equipment including car accessories, safety devices, etc.) and whose malfunction or operational error may endanger human life and sufficient fail-safe measures, please consult with the Company's sales staff in advance. If product malfunctions may result in serious damage, including that to human life, sufficient fail-safe measures must be taken, including the following:
 - [a] Installation of protection circuits or other protective devices to improve system safety
 - [b] Installation of redundant circuits in the case of single-circuit failure
- 2) The products are designed for use in a standard environment and not in any special environments. Application of the products in a special environment can deteriorate product performance. Accordingly, verification and confirmation of product performance, prior to use, is recommended if used under the following conditions:
 - [a] Use in various types of liquid, including water, oils, chemicals, and organic solvents
 - [b] Use outdoors where the products are exposed to direct sunlight, or in dusty places
 - [c] Use in places where the products are exposed to sea winds or corrosive gases, including Cl₂, H₂S, NH₃, SO₂, and NO₂
 - [d] Use in places where the products are exposed to static electricity or electromagnetic waves
 - [e] Use in proximity to heat-producing components, plastic cords, or other flammable items
 - [f] Use involving sealing or coating the products with resin or other coating materials
 - [g] Use involving unclean solder or use of water or water-soluble cleaning agents for cleaning after soldering
 - [h] Use of the products in places subject to dew condensation
- 3) The products are not radiation resistant.
- 4) The Company is not responsible for any problems resulting from use of the products under conditions not recommended herein.
- 5) The Company should be notified of any product safety issues. Moreover, product safety issues should be periodically monitored by the customer.

Precautions Regarding Application Example and External Circuits

- 1) If change is made to the constant of an external circuit, allow a sufficient margin due to variations of the characteristics of the products and external components, including transient characteristics, as well as static characteristics. Please be informed that the Company has not conducted investigations on whether or not particular changes in the application examples or external circuits would result in the infringement of patent rights of a third party.
- 2) The application examples, their constants, and other types of information contained herein are applicable only when the products are used in accordance with standard methods.
Therefore, if mass production is intended, sufficient consideration to external conditions must be made.

Prohibitions Regarding Industrial Property

- 1) These Specifications contain information related to the Company's industrial property. Any use of them other than pertaining to the usage of appropriate products is not permitted. Duplication of these Specifications and its disclosure to a third party without the Company's permission is prohibited.
- 2) Information and data on products, including application examples, contained in these specifications are simply for reference; the Company does not guarantee any industrial property rights, intellectual property rights, or any other rights of a third party regarding this information or data. Accordingly, the Company does not bear any responsibility for:
 - [a] infringement of the intellectual property rights of a third party
 - [b] any problems incurred by the use of the products listed herein.
- 3) The Company prohibits the purchaser of its products to exercise or use the intellectual property rights, industrial property rights, or any other rights that either belong to or are controlled by the Company, other than the right to use, sell, or dispose of the products.

Notes

- No technical content pages of this document may be reproduced in any form or transmitted by any means without prior permission of ROHM CO.,LTD.
- The contents described herein are subject to change without notice. The specifications for the product described in this document are for reference only. Upon actual use, therefore, please request that specifications to be separately delivered.
- Application circuit diagrams and circuit constants contained herein are shown as examples of standard use and operation. Please pay careful attention to the peripheral conditions when designing circuits and deciding upon circuit constants in the set.
- Any data, including, but not limited to application circuit diagrams information, described herein are intended only as illustrations of such devices and not as the specifications for such devices. ROHM CO.,LTD. disclaims any warranty that any use of such devices shall be free from infringement of any third party's intellectual property rights or other proprietary rights, and further, assumes no liability of whatsoever nature in the event of any such infringement, or arising from or connected with or related to the use of such devices.
- Upon the sale of any such devices, other than for buyer's right to use such devices itself, resell or otherwise dispose of the same, no express or implied right or license to practice or commercially exploit any intellectual property rights or other proprietary rights owned or controlled by
- ROHM CO., LTD. is granted to any such buyer.
- Products listed in this document are no antiradiation design.

The products listed in this document are designed to be used with ordinary electronic equipment or devices (such as audio visual equipment, office-automation equipment, communications devices, electrical appliances and electronic toys).

Should you intend to use these products with equipment or devices which require an extremely high level of reliability and the malfunction of which would directly endanger human life (such as medical instruments, transportation equipment, aerospace machinery, nuclear-reactor controllers, fuel controllers and other safety devices), please be sure to consult with our sales representative in advance.

About Export Control Order in Japan

Products described herein are the objects of controlled goods in Annex 1 (Item 16) of Export Trade Control Order in Japan.

In case of export from Japan, please confirm if it applies to "objective" criteria or an "informed" (by MITI clause) on the basis of "catch all controls for Non-Proliferation of Weapons of Mass Destruction.