

BLFA054MGCK-28V

MEGA GREEN

Features

- BUILT-IN CURRENT LIMITING RESISTOR FOR DIRECT APPLICATION OF DIFFERENT ACROSS CURRENT.
- LONG LIFE.
- LOW MAINTENANCE.
- DIFFERENT COLOR AVAILABLE.
- SOLID STATE, HIGH VIBRATION RESISTANT.
- 28V INTERNAL RESISTOR.

Description

The Mega Green source color devices are made with DH InGaAlP on GaAs substrate Light Emitting Diode.

Package Dimensions

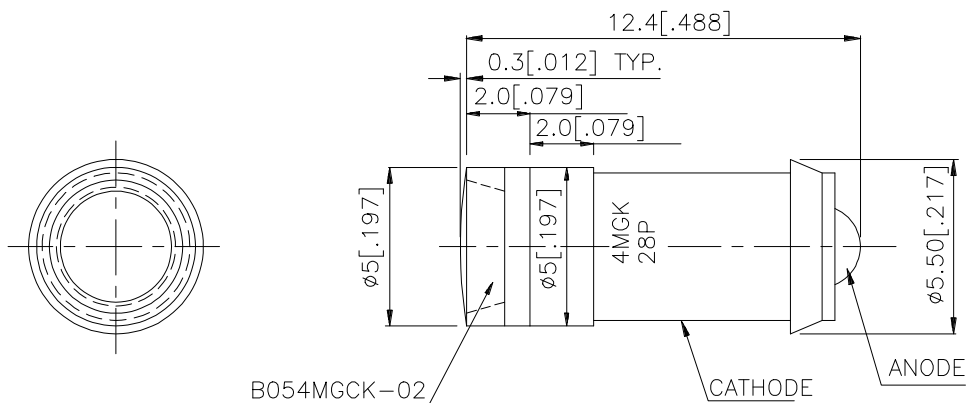

Notes:

1. All dimensions are in millimeters (inches).
2. Tolerance is ± 0.25 (0.01") unless otherwise noted.
3. Specifications are subject to change without notice.

Selection Guide

Part No.	Dice	Lens Type	I _v (mcd) V=28V		Viewing Angle
			Min.	Typ.	2θ1/2
BLFA054MGCK-28V	MEGA GREEN (InGaAlP)	WATER CLEAR	180	460	110°

Note:

1. θ1/2 is the angle from optical centerline where the luminous intensity is 1/2 the optical centerline value.

Electrical / Optical Characteristics at T_A=25°C

Symbol	Parameter	Device	Typ.	Max.	Units	Test Conditions
λ _{peak}	Peak Wavelength	Mega Green	574	-	nm	V _F =28V
λ _D	Dominate Wavelength	Mega Green	570	-	nm	V _F =28V
Δλ _{1/2}	Spectral Line Half-width	Mega Green	20	-	nm	V _F =28V
C	Capacitance	Mega Green	15	-	pF	V _F =0V;f=1MHz
I _F	Forward Current	Mega Green	10	-	mA	V _F =28V
I _R	Reverse Current	Mega Green	-	10	μA	V _R =5V

Absolute Maximum Ratings at T_A=25°C

Parameter	Mega Green	Units
Power dissipation	300	mW
Forward Voltage	30	V
Reverse Voltage	5	V
Operating Temperature	-40 °C To +70 °C	
Storage Temperature	-40 °C To + 85 °C	

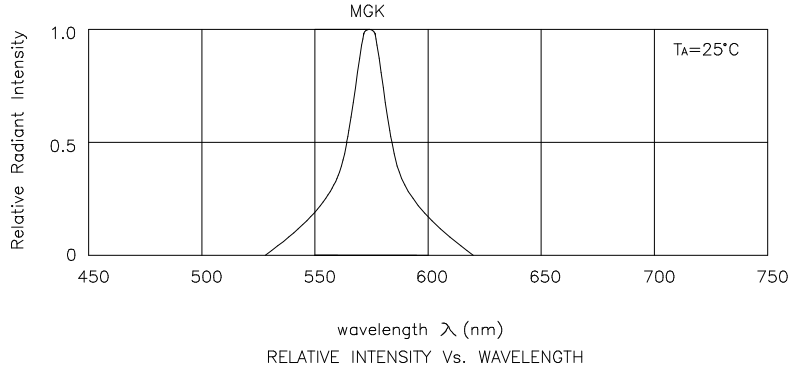

Mega Green

BLFA054MGCK-28V

