

# NPN Epitaxial Planar Transistor

## BF420A3/S

### Description

- NPN high voltage transistors in a TO-92 plastic package.
- Complementary to BF421A3/S.
- Pb-free package is available

### Features

- Low feedback capacitance.

### Applications

- Class-B video output stages in color television and professional monitor equipment.

### Symbol

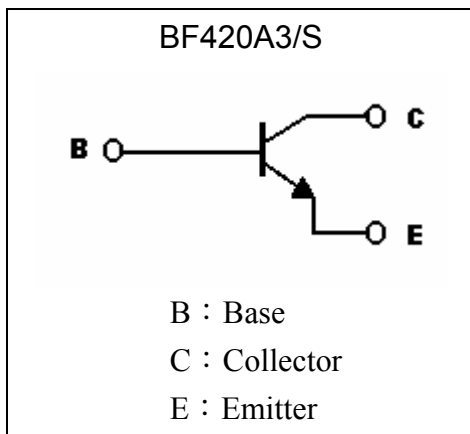

### Outline

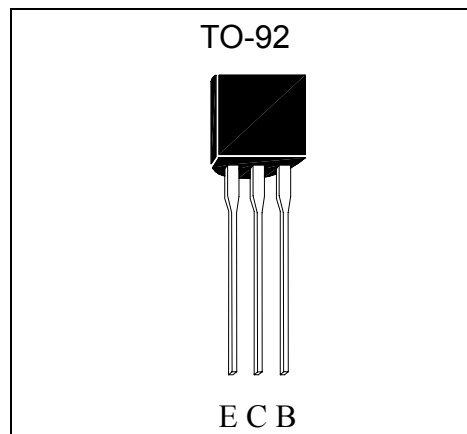

### Absolute Maximum Ratings (Ta=25°C)

Parameter	Symbol	Conditions	Min	Max	Unit
Collector-Base Voltage	V <sub>CB0</sub>	Open emitter		300	V
Collector-Emitter Voltage	V <sub>CE0</sub>	Open base		300	V
Emitter-Base Voltage	V <sub>EBO</sub>	Open collector		5	V
Collector Current (DC)	I <sub>C</sub>			50	mA
Peak Collector Current	I <sub>CM</sub>			100	mA
Peak Base Current	I <sub>BM</sub>			50	mA
Power Dissipation;	P <sub>d</sub>	T <sub>amb</sub> ≤ 25°C ; Note		830	mW
Junction Temperature	T <sub>j</sub>			150	°C
Storage Temperature	T <sub>stg</sub>		-65	+150	°C
Operating Ambient Temperature	T <sub>amb</sub>		-65	+150	°C

Note : Transistor mounted on a printed-circuit board.

**Characteristics (Ta=25°C)**

Symbol	Min.	Typ.	Max.	Unit	Test Conditions
BV <sub>CB0</sub>	300	-	-	V	I <sub>C</sub> =100μA
BV <sub>CEO</sub>	300	-	-	V	I <sub>C</sub> =1mA
BV <sub>EBO</sub>	5	-	-	V	I <sub>E</sub> =10μA
I <sub>CB0</sub>	-	-	10	nA	I <sub>E</sub> =0, V <sub>CB</sub> =200V
	-	-	10	μA	I <sub>E</sub> =0, V <sub>CB</sub> =200V, T <sub>j</sub> =150°C
I <sub>EBO</sub>	-	-	50	nA	I <sub>C</sub> =0, V <sub>EB</sub> =5V
*V <sub>CE(sat)</sub>	-	-	0.6	V	I <sub>C</sub> =30mA, I <sub>B</sub> =5mA
*h <sub>FE</sub>	50	-	-	-	V <sub>CE</sub> =20V, I <sub>C</sub> =25mA
Cre	-	-	1.6	pF	I <sub>C</sub> =I <sub>C</sub> =0, V <sub>CE</sub> =30V, f=1MHz
f <sub>T</sub>	60	-	-	MHz	V <sub>CE</sub> =10V, I <sub>C</sub> =10mA, f=100MHz

\*Pulse Test: Pulse Width ≤380μs, Duty Cycle≤2%

**Thermal Characteristics**

Symbol	Parameter	Conditions	Value	Unit
R <sub>thJA</sub>	Thermal resistance from junction to ambient	Note	150	K/W

Note : Transistor mounted on a printed-circuit board

**Ordering Information**

Device	Package	Shipping
BF420A3	TO-92	2000 pcs / tape & box
BF420A3S	TO-92 (Pb-free)	2000 pcs / tape & box



### Characteristic Curves

Current Gain vs Collector Current

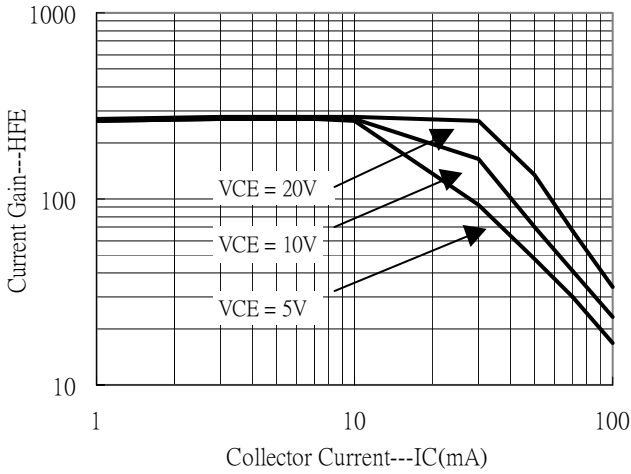

Saturation Voltage vs Collector Current

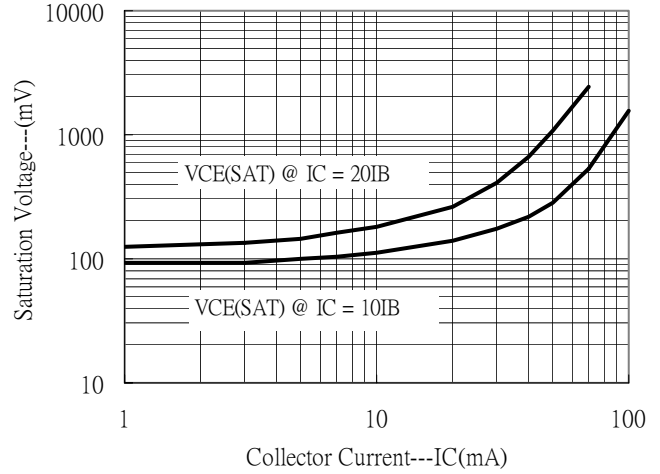

Saturation Voltage vs Collector Current

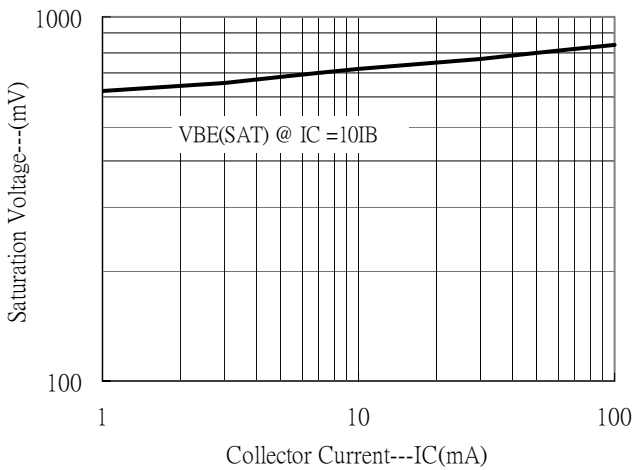

Power Derating Curve

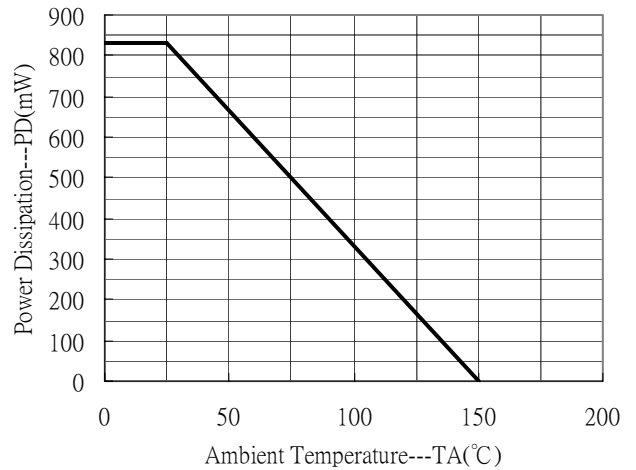

**TO-92 Dimension**

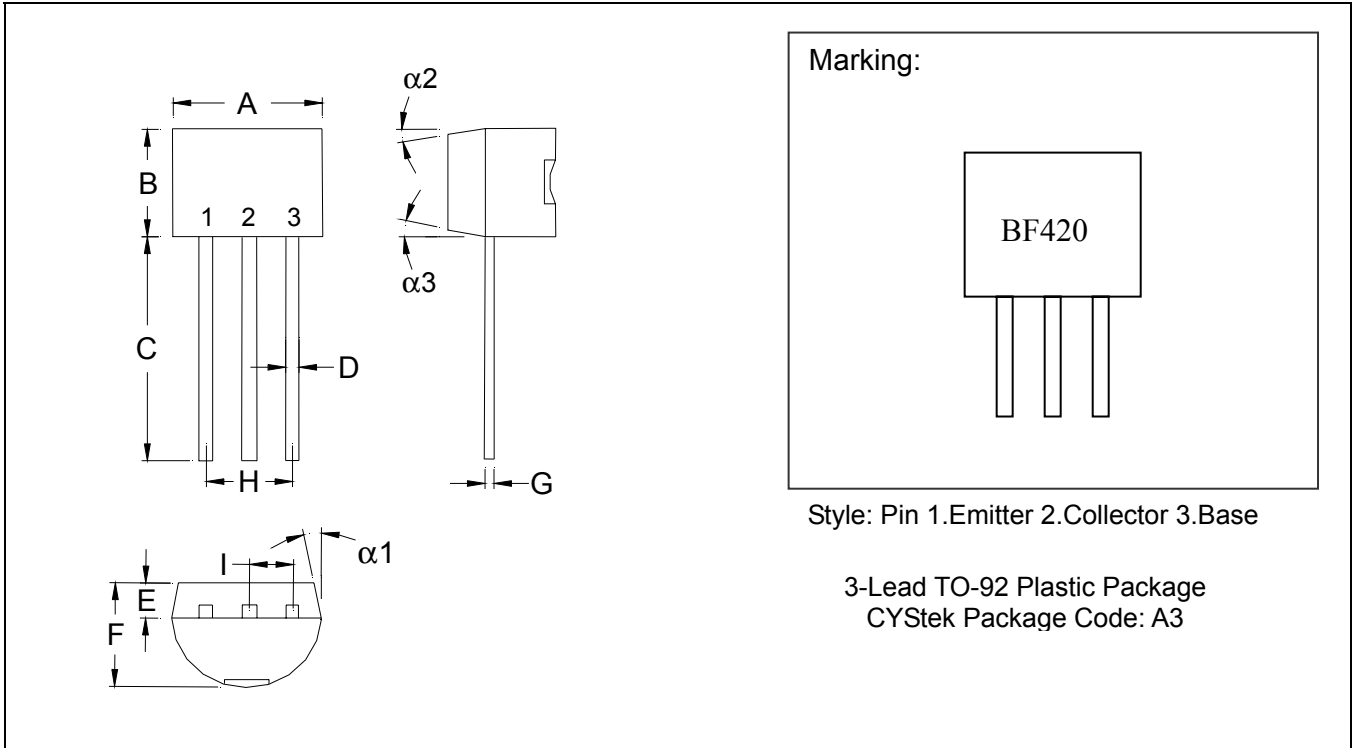

\*: Typical

DIM	Inches		Millimeters		DIM	Inches		Millimeters	
	Min.	Max.	Min.	Max.		Min.	Max.	Min.	Max.
A	0.1704	0.1902	4.33	4.83	G	0.0142	0.0220	0.36	0.56
B	0.1704	0.1902	4.33	4.83	H	-	*0.1000	-	*2.54
C	0.5000	-	12.70	-	I	-	*0.0500	-	*1.27
D	0.0142	0.0220	0.36	0.56	$\alpha 1$	-	*5°	-	*5°
E	-	*0.0500	-	*1.27	$\alpha 2$	-	*2°	-	*2°
F	0.1323	0.1480	3.36	3.76	$\alpha 3$	-	*2°	-	*2°

Notes: 1. Controlling dimension: millimeters.  
 2. Maximum lead thickness includes lead finish thickness, and minimum lead thickness is the minimum thickness of base material.  
 3. If there is any question with packing specification or packing method, please contact your local CYStek sales office.

**Material:**

- Lead: 42 Alloy ; solder plating
- Mold Compound: Epoxy resin family, flammability solid burning class: UL94V-0

**Important Notice:**

- All rights are reserved. Reproduction in whole or in part is prohibited without the prior written approval of CYStek.
- CYStek reserves the right to make changes to its products without notice.
- CYStek **semiconductor products are not warranted to be suitable for use in Life-Support Applications, or systems.**
- CYStek assumes no liability for any consequence of customer product design, infringement of patents, or application assistance.