



BF1205C

Dual N-channel dual gate MOS-FET

Rev. 01 — 18 May 2004

Product data sheet

1. Product profile

1.1 General description

The BF1205C is a combination of two dual gate MOS-FET amplifiers with shared source and gate 2 leads and an integrated switch. The integrated switch is operated by the gate 1 bias of amplifier b.

The source and substrate are interconnected. Internal bias circuits enable DC stabilization and a very good cross-modulation performance during AGC. Integrated diodes between the gates and source protect against excessive input voltage surges. The transistor has a SOT363 micro-miniature plastic package.

CAUTION



This device is sensitive to electrostatic discharge (ESD). Therefore care should be taken during transport and handling.

1.2 Features

- Two low noise gain controlled amplifiers in a single package; one with a fully integrated bias and one with a partly integrated bias
- Internal switch to save external components
- Superior cross-modulation performance during AGC
- High forward transfer admittance
- High forward transfer admittance to input capacitance ratio.

1.3 Applications

- Gain controlled low noise amplifiers for VHF and UHF applications with 5 V supply voltage
 - ◆ digital and analog television tuners
 - ◆ professional communication equipment.

PHILIPS

1.4 Quick reference data

Table 1: Quick reference data

Per MOS-FET unless otherwise specified.

Symbol	Parameter	Conditions	Min	Typ	Max	Unit
V_{DS}	drain-source voltage		-	-	6	V
I_D	drain current (DC)		-	-	30	mA
P_{tot}	total power dissipation	$T_s \leq 107\text{ }^\circ\text{C}$	[1]	-	180	mW
$ y_{fs} $	forward transfer admittance	$f = 1\text{ MHz}$				
		amplifier a; $I_D = 19\text{ mA}$	26	31	41	mS
		amplifier b; $I_D = 13\text{ mA}$	28	33	43	mS
C_{ig1-ss}	input capacitance at gate 1	$f = 1\text{ MHz}$				
		amplifier a	-	2.2	2.7	pF
		amplifier b	-	2.0	2.5	pF
C_{rss}	reverse transfer capacitance	$f = 1\text{ MHz}$	-	20	-	fF
NF	noise figure	amplifier a; $f = 400\text{ MHz}$	-	1.3	1.9	dB
		amplifier b; $f = 800\text{ MHz}$	-	1.4	2.1	dB
X_{mod}	cross-modulation	input level for $k = 1\%$ at 40 dB AGC				
		amplifier a	100	105	-	dB μ V
		amplifier b	100	103	-	dB μ V
T_j	junction temperature		-	-	150	$^\circ\text{C}$

[1] T_s is the temperature at the soldering point of the source lead.

2. Pinning information

Table 2: Discrete pinning

Pin	Description	Simplified outline	Symbol
1	gate 1 (a)		
2	gate 2		
3	gate 1 (b)		
4	drain (b)		
5	source		
6	drain (a)		

3. Ordering information

Table 3: Ordering information

Type number	Package		
	Name	Description	Version
BF1205C	-	plastic surface mounted package; 6 leads	SOT363

4. Marking

Table 4: Marking

Type number	Marking code ^[1]
BF1205C	M6*

- [1] * = p or -: made in Hong Kong.
 * = t: made in Malaysia.
 * = W: made in China.

5. Limiting values

Table 5: Limiting values

In accordance with the Absolute Maximum Rating System (IEC 60134).

Symbol	Parameter	Conditions	Min	Max	Unit
Per MOS-FET					
V_{DS}	drain-source voltage		-	6	V
I_D	drain current (DC)		-	30	mA
I_{G1}	gate 1 current		-	±10	mA
I_{G2}	gate 2 current		-	±10	mA
P_{tot}	total power dissipation	$T_s \leq 107\text{ °C}$ ^[1]	-	180	mW
T_{stg}	storage temperature		-65	+150	°C
T_j	junction temperature		-	150	°C

- [1] T_s is the temperature at the soldering point of the source lead.

6. Thermal characteristics

Table 6: Thermal characteristics

Symbol	Parameter	Conditions	Typ	Unit
$R_{th(j-s)}$	thermal resistance from junction to soldering point		240	K/W

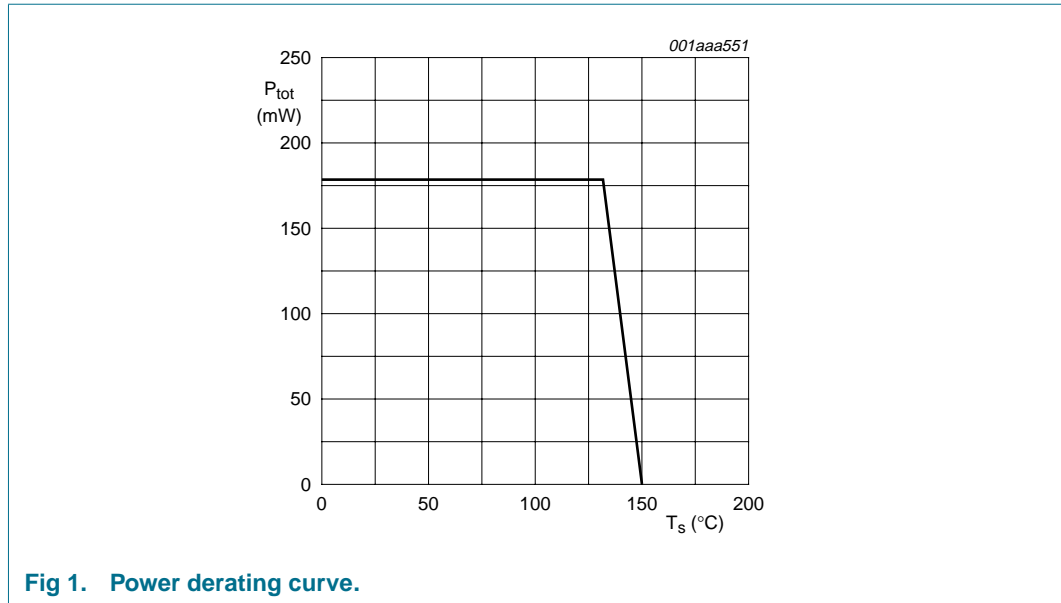

Fig 1. Power derating curve.

7. Static characteristics

Table 7: Static characteristics

T_j = 25 °C.

Symbol	Parameter	Conditions	Min	Typ	Max	Unit
Per MOS-FET; unless otherwise specified						
V _{(BR)DSS}	drain-source breakdown voltage	V _{G1-S} = V _{G2-S} = 0 V; I _D = 10 μA				
		amplifier a	6	-	-	V
		amplifier b	6	-	-	V
V _{(BR)G1-SS}	gate 1-source breakdown voltage	V _{GS} = V _{DS} = 0 V; I _{G1-S} = 10 mA	6	-	10	V
V _{(BR)G2-SS}	gate 2-source breakdown voltage	V _{GS} = V _{DS} = 0 V; I _{G2-S} = 10 mA	6	-	10	V
V _{(F)S-G1}	forward source-gate 1 voltage	V _{G2-S} = V _{DS} = 0 V; I _{S-G1} = 10 mA	0.5	-	1.5	V
V _{(F)S-G2}	forward source-gate 2 voltage	V _{G1-S} = V _{DS} = 0 V; I _{S-G2} = 10 mA	0.5	-	1.5	V
V _{G1-S(th)}	gate 1-source threshold voltage	V _{DS} = 5 V; V _{G2-S} = 4 V; I _D = 100 μA	0.3	-	1.0	V
V _{G2-S(th)}	gate 2-source threshold voltage	V _{DS} = 5 V; V _{G1-S} = 5 V; I _D = 100 μA	0.4	-	1.0	V
I _{DSX}	drain-source current	V _{G2-S} = 4 V; V _{DS(b)} = 5 V; R _{G1} = 150 kΩ				
		amplifier a; V _{DS(a)} = 5 V	[1] 14	-	24	mA
		amplifier b	[2] 9	-	17	mA
I _{G1-S}	gate1 cut-off current	V _{G2-S} = V _{DS(a)} = 0 V				
		amplifier a; V _{G1-S(a)} = 5 V; I _{D(b)} = 0 A	-	-	50	nA
		amplifier b; V _{G1-S(b)} = 5 V; V _{DS(b)} = 0 V	-	-	50	nA
I _{G2-S}	gate 2 cut-off current	V _{G2-S} = 4 V; V _{G1-S(a)} = V _{DS(a)} = V _{DS(b)} = 0 V; V _{G1-S(b)} = 0 V;	-	-	20	nA

[1] R_{G1} connects gate 1 (b) to V_{GG} = 0 V (see [Figure 3](#)).

[2] R_{G1} connects gate 1 (b) to V_{GG} = 5 V (see [Figure 3](#)).

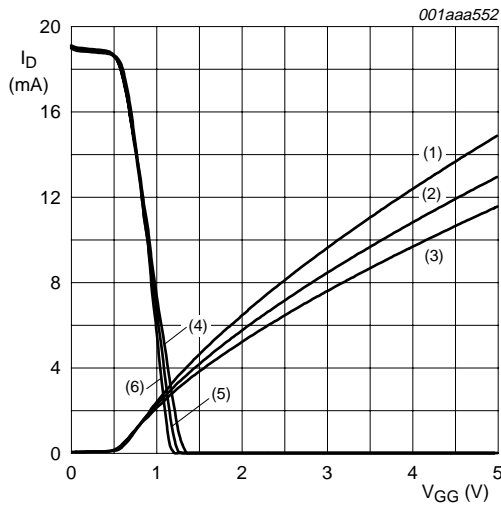

- (1) $I_{D(b)}$; $R_{G1} = 120 \text{ k}\Omega$.
- (2) $I_{D(b)}$; $R_{G1} = 150 \text{ k}\Omega$.
- (3) $I_{D(b)}$; $R_{G1} = 180 \text{ k}\Omega$.
- (4) $I_{D(a)}$; $R_{G1} = 180 \text{ k}\Omega$.
- (5) $I_{D(a)}$; $R_{G1} = 150 \text{ k}\Omega$.
- (6) $I_{D(a)}$; $R_{G1} = 120 \text{ k}\Omega$.

Fig 2. Drain currents of MOS-FET a and b as function of V_{GG} .

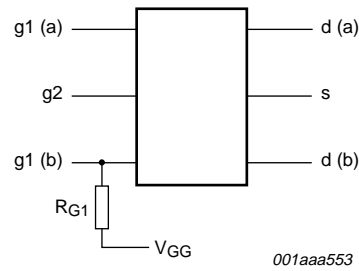

$V_{GG} = 5 \text{ V}$: amplifier a is off; amplifier b is on
 $V_{GG} = 0 \text{ V}$: amplifier a is on; amplifier b is off.

Fig 3. Functional diagram.

8. Dynamic characteristics

8.1 Dynamic characteristics for amplifier a

Table 8: Dynamic characteristics for amplifier a [\[1\]](#)

Common source; $T_{amb} = 25 \text{ }^\circ\text{C}$; $V_{G2-S} = 4 \text{ V}$; $V_{DS} = 5 \text{ V}$; $I_D = 19 \text{ mA}$.

Symbol	Parameter	Conditions	Min	Typ	Max	Unit
$ y_{fs} $	forward transfer admittance	$T_j = 25 \text{ }^\circ\text{C}$	26	31	41	mS
C_{ig1-ss}	input capacitance at gate 1	$f = 1 \text{ MHz}$	-	2.2	2.7	pF
C_{ig2-ss}	input capacitance at gate 2	$f = 1 \text{ MHz}$	-	3.0	-	pF
C_{oss}	output capacitance	$f = 1 \text{ MHz}$	-	0.9	-	pF
C_{rss}	reverse transfer capacitance	$f = 1 \text{ MHz}$	-	20	-	fF
G_{tr}	power gain	$B_S = B_{S(opt)}$; $B_L = B_{L(opt)}$				
		$f = 200 \text{ MHz}$; $G_S = 2 \text{ mS}$; $G_L = 0.5 \text{ mS}$	31	35	39	dB
		$f = 400 \text{ MHz}$; $G_S = 2 \text{ mS}$; $G_L = 1 \text{ mS}$	26	30	34	dB
		$f = 800 \text{ MHz}$; $G_S = 3.3 \text{ mS}$; $G_L = 1 \text{ mS}$	21	25	29	dB
NF	noise figure	$f = 11 \text{ MHz}$; $G_S = 20 \text{ mS}$; $B_S = 0 \text{ S}$	-	3.0	-	dB
		$f = 400 \text{ MHz}$; $Y_S = Y_{S(opt)}$	-	1.3	1.9	dB
		$f = 800 \text{ MHz}$; $Y_S = Y_{S(opt)}$	-	1.4	2.1	dB

Table 8: Dynamic characteristics for amplifier a [1] ...continued
 Common source; $T_{amb} = 25\text{ }^\circ\text{C}$; $V_{G2-S} = 4\text{ V}$; $V_{DS} = 5\text{ V}$; $I_D = 19\text{ mA}$.

Symbol	Parameter	Conditions	Min	Typ	Max	Unit
X_{mod}	cross-modulation	input level for $k = 1\%$; $f_w = 50\text{ MHz}$; $f_{unw} = 60\text{ MHz}$ [2]				
		at 0 dB AGC	90	-	-	dB μ V
		at 10 dB AGC	-	90	-	dB μ V
		at 20 dB AGC	-	99	-	dB μ V
		at 40 dB AGC	100	105	-	dB μ V

[1] For the MOS-FET not in use: $V_{G1-S(b)} = 0\text{ V}$; $V_{DS(b)} = 0\text{ V}$.

[2] Measured in Figure 33 test circuit.

8.1.1 Graphs for amplifier a

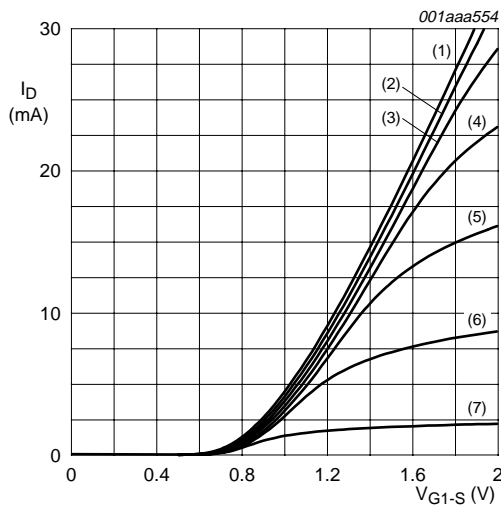

- (1) $V_{G2-S} = 4\text{ V}$.
 - (2) $V_{G2-S} = 3.5\text{ V}$.
 - (3) $V_{G2-S} = 3\text{ V}$.
 - (4) $V_{G2-S} = 2.5\text{ V}$.
 - (5) $V_{G2-S} = 2\text{ V}$.
 - (6) $V_{G2-S} = 1.5\text{ V}$.
 - (7) $V_{G2-S} = 1\text{ V}$.
- $V_{DS(a)} = 5\text{ V}$; $V_{G1-S(b)} = V_{DS(b)} = 0\text{ V}$; $T_j = 25\text{ }^\circ\text{C}$.

Fig 4. Transfer characteristics; typical values.

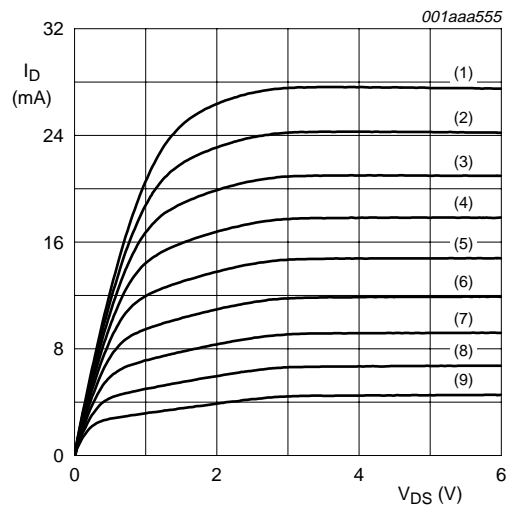

- (1) $V_{G1-S(a)} = 1.8\text{ V}$.
 - (2) $V_{G1-S(a)} = 1.7\text{ V}$.
 - (3) $V_{G1-S(a)} = 1.6\text{ V}$.
 - (4) $V_{G1-S(a)} = 1.5\text{ V}$.
 - (5) $V_{G1-S(a)} = 1.4\text{ V}$.
 - (6) $V_{G1-S(a)} = 1.3\text{ V}$.
 - (7) $V_{G1-S(a)} = 1.2\text{ V}$.
 - (8) $V_{G1-S(a)} = 1.1\text{ V}$.
 - (9) $V_{G1-S(a)} = 1\text{ V}$.
- $V_{G2-S} = 4\text{ V}$; $V_{G1-S(b)} = V_{DS(b)} = 0\text{ V}$; $T_j = 25\text{ }^\circ\text{C}$.

Fig 5. Output characteristics; typical values.

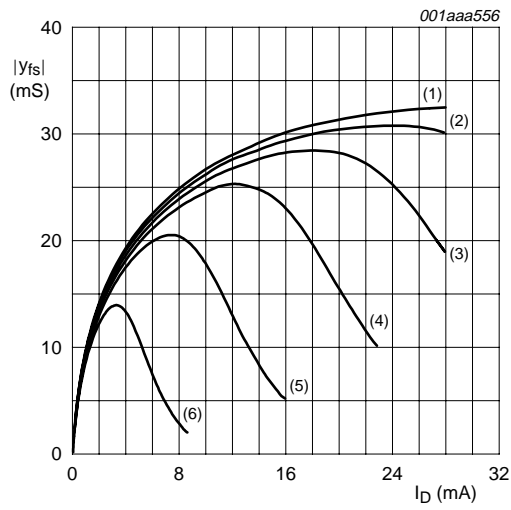

- (1) $V_{G2-S} = 4$ V.
 - (2) $V_{G2-S} = 3.5$ V.
 - (3) $V_{G2-S} = 3$ V.
 - (4) $V_{G2-S} = 2.5$ V.
 - (5) $V_{G2-S} = 2$ V.
 - (6) $V_{G2-S} = 1.5$ V.
- $V_{DS(a)} = 5$ V; $V_{G1-S(b)} = V_{DS(b)} = 0$ V; $T_j = 25$ °C.

Fig 6. Forward transfer admittance as a function of drain current; typical values.

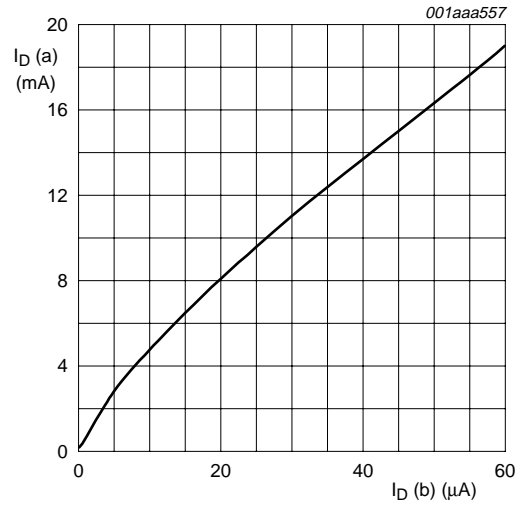

- $V_{DS(a)} = 5$ V; $V_{G2-S} = 4$ V; $V_{DS(b)} = 5$ V;
 $V_{G1-S(b)} = 0$ V; $T_j = 25$ °C.

Fig 7. Drain current as a function of internal G1 current (current in pin drain (b) if MOS-FET (b) is switched off); typical values.

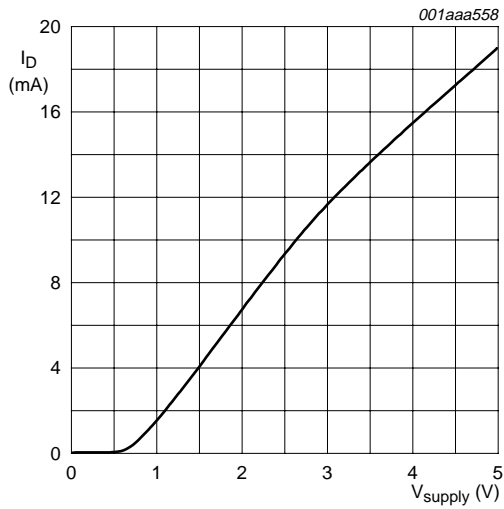

$V_{DS(a)} = V_{DS(b)} = V_{supply}$, $V_{G2-S} = 4$ V, $T_j = 25$ °C, $R_{G1(b)} = 150$ k Ω (connected to ground); see [Figure 3](#).

Fig 8. Drain current of amplifier a as a function of supply voltage of a and b amplifier; typical values.

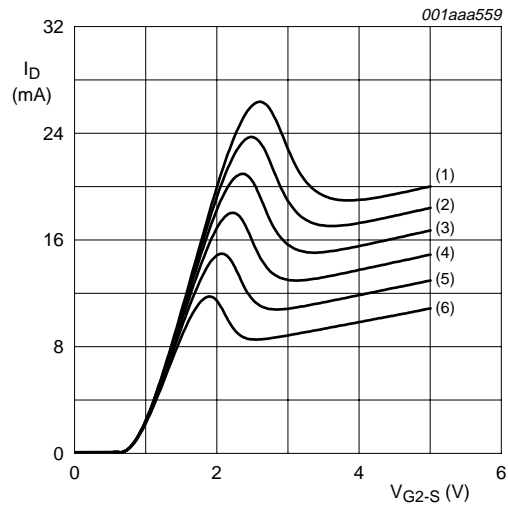

(1) $V_{DS(b)} = 5$ V.
 (2) $V_{DS(b)} = 4.5$ V.
 (3) $V_{DS(b)} = 4$ V.
 (4) $V_{DS(b)} = 3.5$ V.
 (5) $V_{DS(b)} = 3$ V.
 (6) $V_{DS(b)} = 2.5$ V.
 $V_{DS(a)} = 5$ V; $V_{G1-S(b)} = 0$ V; gate 1 (a) = open;
 $T_j = 25$ °C.

Fig 9. Drain current as a function of gate 2 and drain supply voltage; typical values.

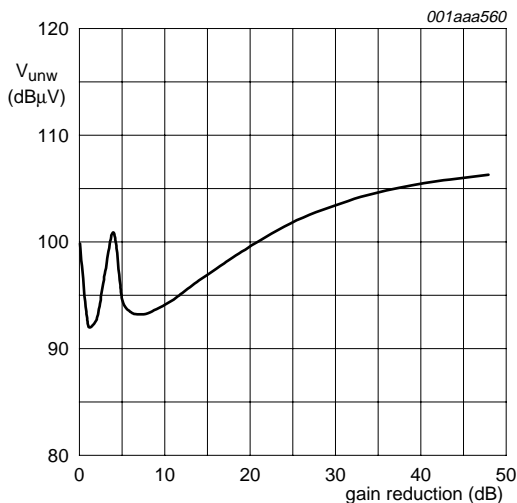

$V_{DS(a)} = V_{DS(b)} = 5$ V; $V_{G1-S(b)} = 0$ V; $f_w = 50$ MHz; $f_{unw} = 60$ MHz; $T_{amb} = 25$ °C; see [Figure 33](#).

Fig 10. Unwanted voltage for 1% cross-modulation as a function of gain reduction; typical values.

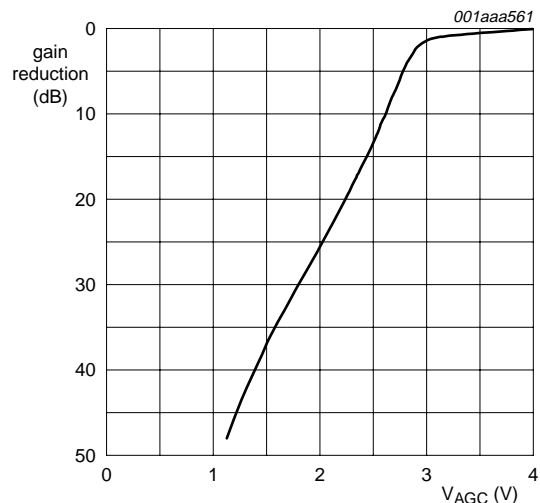

$V_{DS(a)} = V_{DS(b)} = 5$ V; $V_{G1-S(b)} = 0$ V; $f = 50$ MHz; see [Figure 33](#).

Fig 11. Gain reduction as a function of AGC voltage; typical values.

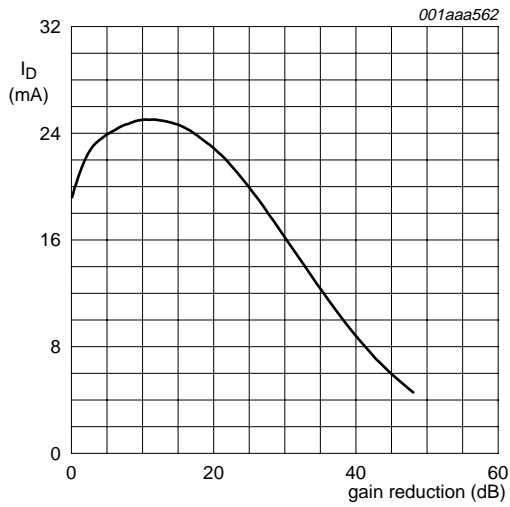

$V_{DS(a)} = V_{DS(b)} = 5\text{ V}$; $V_{G1-S(b)} = 0\text{ V}$; $f = 50\text{ MHz}$;
 $T_{amb} = 25\text{ }^\circ\text{C}$; see [Figure 33](#).

Fig 12. Drain current as a function of gain reduction; typical values.

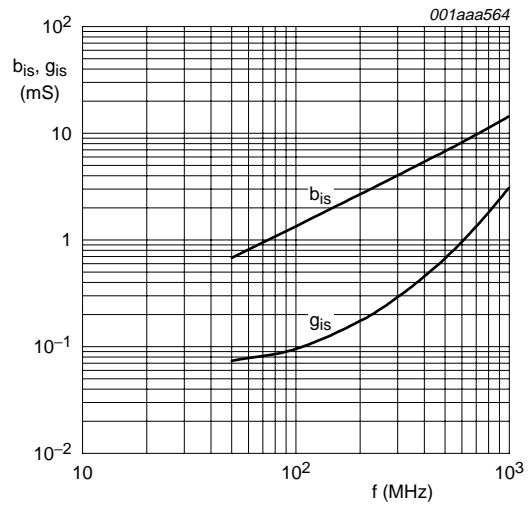

$V_{DS(a)} = 5\text{ V}$; $V_{G2-S(a)} = 4\text{ V}$; $V_{DS(b)} = V_{G1-S(b)} = 0\text{ V}$;
 $I_{D(a)} = 19\text{ mA}$.

Fig 13. Input admittance as a function of frequency; typical values.

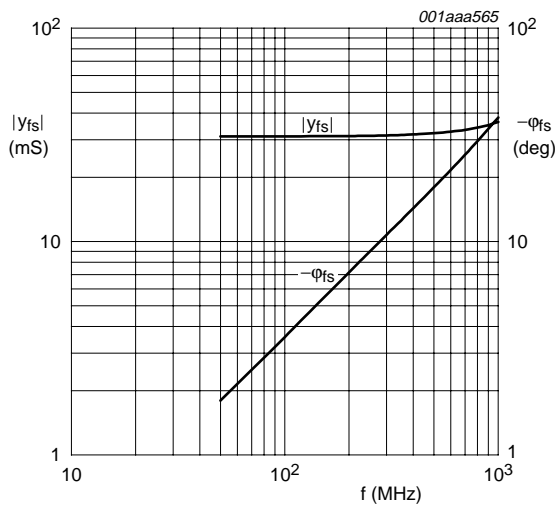

$V_{DS(a)} = 5\text{ V}$; $V_{G2-S(a)} = 4\text{ V}$; $V_{DS(b)} = V_{G1-S(b)} = 0\text{ V}$;
 $I_{D(a)} = 19\text{ mA}$.

Fig 14. Forward transfer admittance and phase as a function of frequency; typical values.

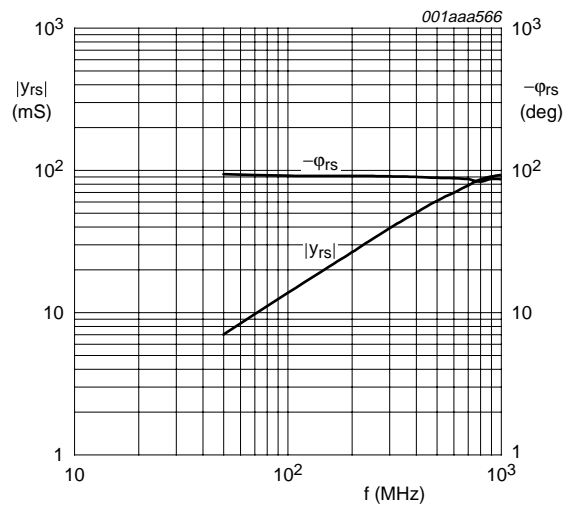

$V_{DS(a)} = 5\text{ V}$; $V_{G2-S(a)} = 4\text{ V}$; $V_{DS(b)} = V_{G1-S(b)} = 0\text{ V}$;
 $I_{D(a)} = 19\text{ mA}$.

Fig 15. Reverse transfer admittance and phase as a function of frequency; typical values.

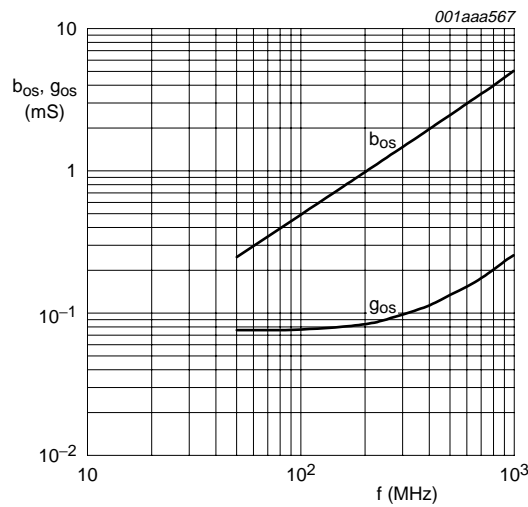

$V_{DS(a)} = 5\text{ V}; V_{G2-S(a)} = 4\text{ V}; V_{DS(b)} = V_{G1-S(b)} = 0\text{ V}; I_{D(a)} = 19\text{ mA}.$

Fig 16. Output admittance as a function of frequency; typical values.

8.1.2 Scattering parameters for amplifier a

Table 9: Scattering parameters for amplifier a

$V_{DS(a)} = 5\text{ V}; V_{G2-S} = 4\text{ V}; I_{D(a)} = 19\text{ mA}; V_{DS(b)} = 0\text{ V}; V_{G-1S(b)} = 0\text{ V}; T_{amb} = 25\text{ }^\circ\text{C}.$

f (MHz)	S ₁₁		S ₂₁		S ₁₂		S ₂₂	
	Magnitude ratio	Angle (deg)	Magnitude ratio	Angle (deg)	Magnitude ratio	Angle (deg)	Magnitude ratio	Angle (deg)
50	0.992	-3.91	3.07	175.56	0.0007	83.61	0.992	-1.47
100	0.990	-7.76	3.06	171.18	0.0017	83.19	0.992	-2.93
200	0.982	-15.42	3.04	162.42	0.0026	78.19	0.990	-5.84
300	0.971	-22.99	3.01	153.79	0.0037	73.75	0.988	-8.71
400	0.956	-30.52	2.96	145.22	0.0047	69.82	0.985	-11.59
500	0.938	-37.83	2.90	136.78	0.0055	66.12	0.982	-14.48
600	0.917	-45.14	2.83	128.46	0.0061	62.11	0.979	-17.31
700	0.893	-52.31	2.76	120.20	0.0065	58.86	0.975	-20.14
800	0.867	-59.47	2.69	111.98	0.0068	58.28	0.972	-22.98
900	0.838	-66.23	2.60	103.90	0.0067	50.64	0.968	-25.85
1000	0.807	-73.10	2.52	95.875	0.0065	47.28	0.966	-28.74

8.1.3 Noise data for amplifier a

Table 10: Noise data for amplifier a

$V_{DS(a)} = 5\text{ V}; V_{G2-S} = 4\text{ V}; I_{D(a)} = 19\text{ mA}; V_{DS(b)} = 0\text{ V}; V_{G-1S(b)} = 0\text{ V}; T_{amb} = 25\text{ }^\circ\text{C}.$

f (MHz)	F _{min} (dB)	Γ _{opt}		r _n (Ω)
		ratio	(deg)	
400	1.3	0.718	16.06	0.683
800	1.4	0.677	37.59	0.681

8.2 Dynamic characteristics for amplifier b

Table 11: Dynamic characteristics for amplifier b

Common source; $T_{amb} = 25\text{ }^\circ\text{C}$; $V_{G2-S} = 4\text{ V}$; $V_{DS} = 5\text{ V}$; $I_D = 13\text{ mA}$.

Symbol	Parameter	Conditions	Min	Typ	Max	Unit
$ y_{fs} $	forward transfer admittance	$T_j = 25\text{ }^\circ\text{C}$	28	33	43	mS
C_{ig1-ss}	input capacitance at gate 1	$f = 1\text{ MHz}$	-	2.0	2.5	pF
C_{ig2-ss}	input capacitance at gate 2	$f = 1\text{ MHz}$	-	3.4	-	pF
C_{oss}	output capacitance	$f = 1\text{ MHz}$	-	0.85	-	pF
C_{rss}	reverse transfer capacitance	$f = 1\text{ MHz}$	-	20	-	fF
G_{tr}	power gain	$B_S = B_{S(opt)}$; $B_L = B_{L(opt)}$	[1]			
		$f = 200\text{ MHz}$; $G_S = 2\text{ mS}$; $G_L = 0.5\text{ mS}$	31	35	39	dB
		$f = 400\text{ MHz}$; $G_S = 2\text{ mS}$; $G_L = 1\text{ mS}$	28	32	36	dB
		$f = 800\text{ MHz}$; $G_S = 3.3\text{ mS}$; $G_L = 1\text{ mS}$	24	28	32	dB
NF	noise figure	$f = 11\text{ MHz}$; $G_S = 20\text{ mS}$; $B_S = 0\text{ S}$	-	5	-	dB
		$f = 400\text{ MHz}$; $Y_S = Y_{S(opt)}$	-	1.3	1.9	dB
		$f = 800\text{ MHz}$; $Y_S = Y_{S(opt)}$	-	1.4	2.1	dB
X_{mod}	cross-modulation	input level for $k = 1\%$; $f_w = 50\text{ MHz}$; $f_{unw} = 60\text{ MHz}$	[2]			
		at 0 dB AGC	90	-	-	dB μ V
		at 10 dB AGC	-	88	-	dB μ V
		at 20 dB AGC	-	94	-	dB μ V
		at 40 dB AGC	100	103	-	dB μ V

[1] For the MOS-FET not in use: $V_{G1-S(a)} = 0\text{ V}$; $V_{DS(a)} = 0\text{ V}$.

[2] Measured in [Figure 34](#) test circuit.

8.2.1 Graphs for amplifier b

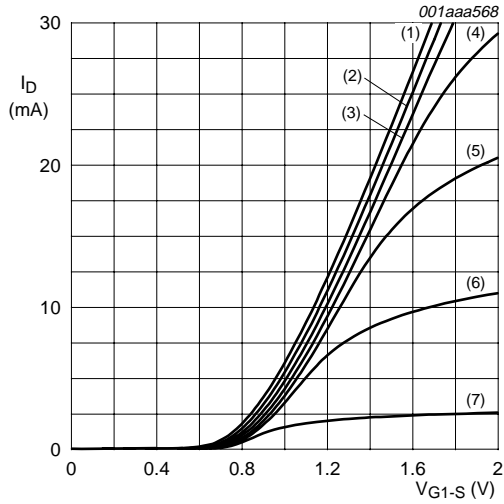

- (1) $V_{G2-S} = 4 \text{ V.}$
- (2) $V_{G2-S} = 3.5 \text{ V.}$
- (3) $V_{G2-S} = 3 \text{ V.}$
- (4) $V_{G2-S} = 2.5 \text{ V.}$
- (5) $V_{G2-S} = 2 \text{ V.}$
- (6) $V_{G2-S} = 1.5 \text{ V.}$
- (7) $V_{G2-S} = 1 \text{ V.}$

$V_{DS(b)} = 5 \text{ V; } V_{DS(a)} = V_{G1-S(a)} = 0 \text{ V; } T_j = 25 \text{ }^\circ\text{C.}$

Fig 17. Transfer characteristics; typical values.

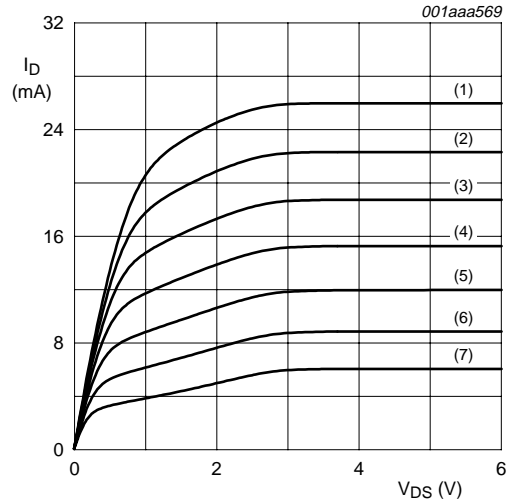

- (1) $V_{G1-S(b)} = 1.6 \text{ V.}$
- (2) $V_{G1-S(b)} = 1.5 \text{ V.}$
- (3) $V_{G1-S(b)} = 1.4 \text{ V.}$
- (4) $V_{G1-S(b)} = 1.3 \text{ V.}$
- (5) $V_{G1-S(b)} = 1.2 \text{ V.}$
- (6) $V_{G1-S(b)} = 1.1 \text{ V.}$
- (7) $V_{G1-S(b)} = 1 \text{ V.}$

$V_{G2-S} = 4 \text{ V; } V_{DS(a)} = V_{G1-S(a)} = 0 \text{ V; } T_j = 25 \text{ }^\circ\text{C.}$

Fig 18. Output characteristics; typical values.

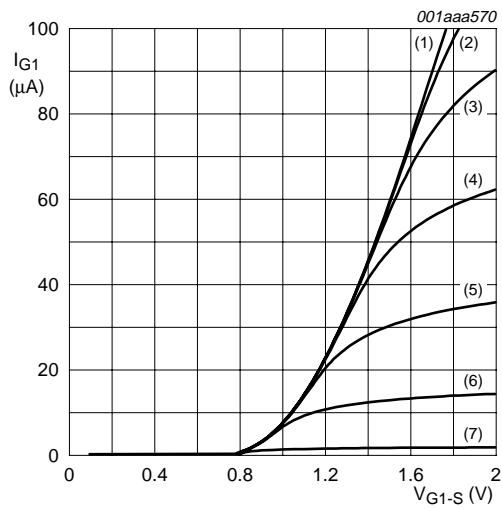

(1) $V_{G2-S} = 4\text{ V}$.
 (2) $V_{G2-S} = 3.5\text{ V}$.
 (3) $V_{G2-S} = 3\text{ V}$.
 (4) $V_{G2-S} = 2.5\text{ V}$.
 (5) $V_{G2-S} = 2\text{ V}$.
 (6) $V_{G2-S} = 1.5\text{ V}$.
 (7) $V_{G2-S} = 1\text{ V}$.
 $V_{DS(b)} = 5\text{ V}$; $V_{DS(a)} = V_{G1-S(a)} = 0\text{ V}$; $T_j = 25\text{ }^\circ\text{C}$.

Fig 19. Gate 1 current as a function of gate 1 voltage; typical values.

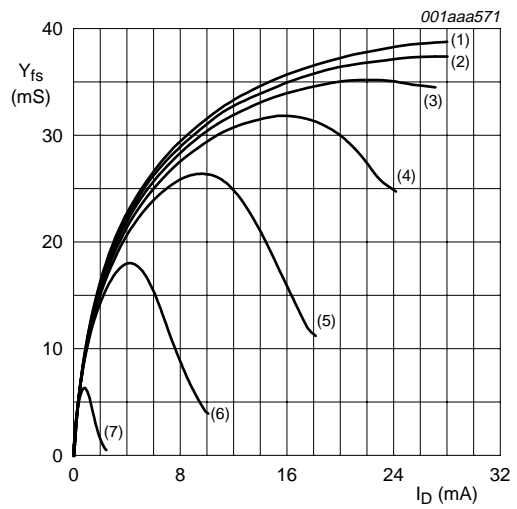

(1) $V_{G2-S} = 4\text{ V}$.
 (2) $V_{G2-S} = 3.5\text{ V}$.
 (3) $V_{G2-S} = 3\text{ V}$.
 (4) $V_{G2-S} = 2.5\text{ V}$.
 (5) $V_{G2-S} = 2\text{ V}$.
 (6) $V_{G2-S} = 1.5\text{ V}$.
 (7) $V_{G2-S} = 1\text{ V}$.
 $V_{DS(b)} = 5\text{ V}$; $V_{DS(a)} = V_{G1-S(a)} = 0\text{ V}$; $T_j = 25\text{ }^\circ\text{C}$.

Fig 20. Forward transfer admittance as a function of drain current; typical values.

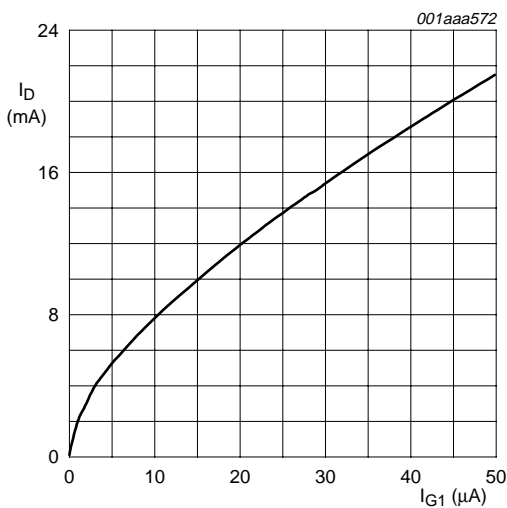

$V_{DS(b)} = 5\text{ V}$; $V_{G2-S} = 4\text{ V}$; $V_{DS(a)} = V_{G1-S(a)} = 0\text{ V}$;
 $T_j = 25\text{ }^\circ\text{C}$.

Fig 21. Drain current as a function of gate 1 current; typical values.

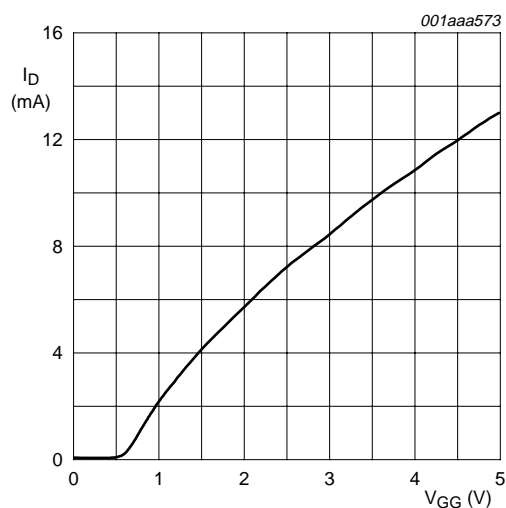

$V_{DS(b)} = 5\text{ V}$; $V_{G2-S} = 4\text{ V}$; $V_{DS(a)} = V_{G1-S(a)} = 0\text{ V}$;
 $T_j = 25\text{ }^\circ\text{C}$; $R_{G1(b)} = 150\text{ k}\Omega$ (connected to V_{GG}); see [Figure 3](#).

Fig 22. Drain current as a function of gate 1 supply voltage (V_{GG}); typical values.

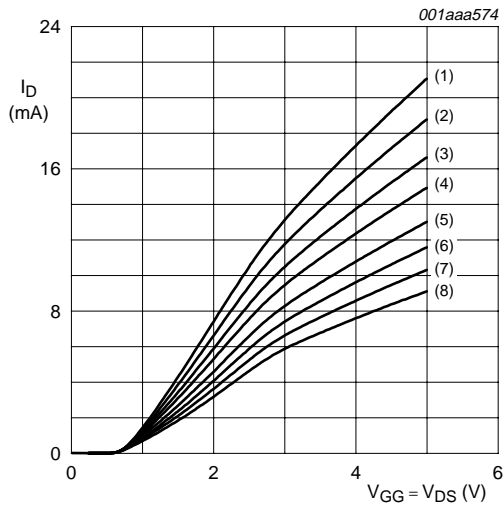

- (1) $R_{G1(b)} = 68 \text{ k}\Omega$.
- (2) $R_{G1(b)} = 82 \text{ k}\Omega$.
- (3) $R_{G1(b)} = 100 \text{ k}\Omega$.
- (4) $R_{G1(b)} = 120 \text{ k}\Omega$.
- (5) $R_{G1(b)} = 150 \text{ k}\Omega$.
- (6) $R_{G1(b)} = 180 \text{ k}\Omega$.
- (7) $R_{G1(b)} = 220 \text{ k}\Omega$.
- (8) $R_{G1(b)} = 270 \text{ k}\Omega$.

$V_{G2-S} = 4 \text{ V}$; $V_{DS(a)} = V_{G1-S(a)} = 0 \text{ V}$; $T_j = 25 \text{ }^\circ\text{C}$;
 $R_{G1(b)}$ is connected to V_{GG} ; see [Figure 3](#).

Fig 23. Drain current as a function of gate 1 (V_{GG}), drain supply voltage and value of R_{G1} ; typical values.

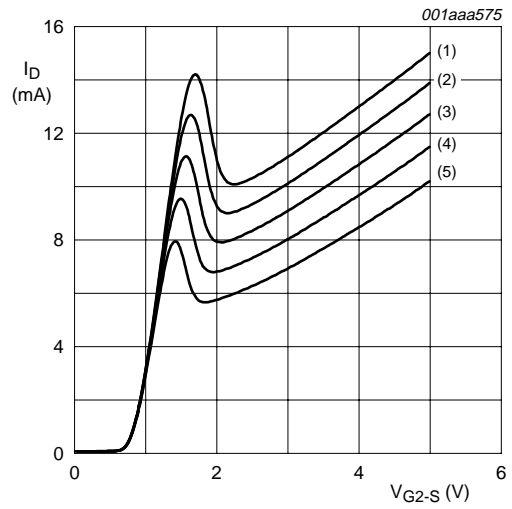

- (1) $V_{GG} = 5.0 \text{ V}$.
- (2) $V_{GG} = 4.5 \text{ V}$.
- (3) $V_{GG} = 4.0 \text{ V}$.
- (4) $V_{GG} = 3.5 \text{ V}$.
- (5) $V_{GG} = 3.0 \text{ V}$.

$V_{DS(b)} = 5 \text{ V}$; $V_{DS(a)} = V_{G1-S(a)} = 0 \text{ V}$; $T_j = 25 \text{ }^\circ\text{C}$;
 $R_{G1(b)} = 150 \text{ k}\Omega$ (connected to V_{GG}); see [Figure 3](#).

Fig 24. Drain current as a function of gate 2 voltage; typical values.

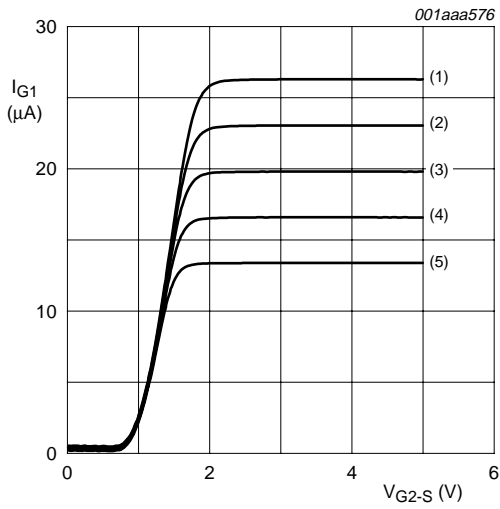

(1) $V_{GG} = 5.0$ V.
 (2) $V_{GG} = 4.5$ V.
 (3) $V_{GG} = 4.0$ V.
 (4) $V_{GG} = 3.5$ V.
 (5) $V_{GG} = 3.0$ V.
 $V_{DS(b)} = 5$ V; $V_{DS(a)} = V_{G1-S(a)} = 0$ V; $T_j = 25$ °C;
 $R_{G1(b)} = 150$ k Ω (connected to V_{GG}); see [Figure 3](#).

Fig 25. Gate 1 current as a function of gate 2 voltage; typical values.

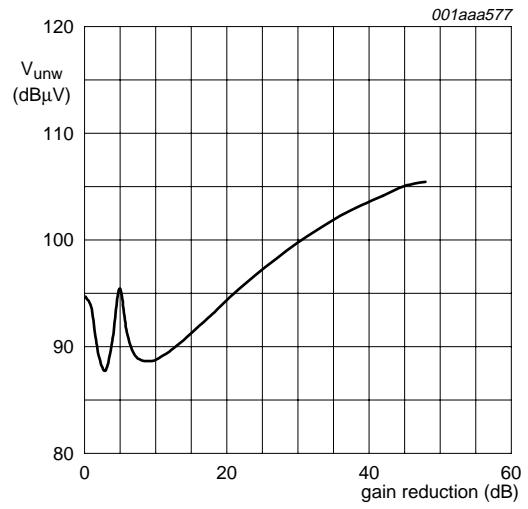

$V_{DS(b)} = 5$ V; $V_{GG} = 5$ V; $V_{DS(a)} = V_{G1-S(a)} = 0$ V;
 $R_{G1(b)} = 150$ k Ω (connected to V_{GG}); $f_w = 50$ MHz;
 $f_{unw} = 60$ MHz; $T_{amb} = 25$ °C; see [Figure 34](#).

Fig 26. Unwanted voltage for 1% cross-modulation as a function of gain reduction; typical values.

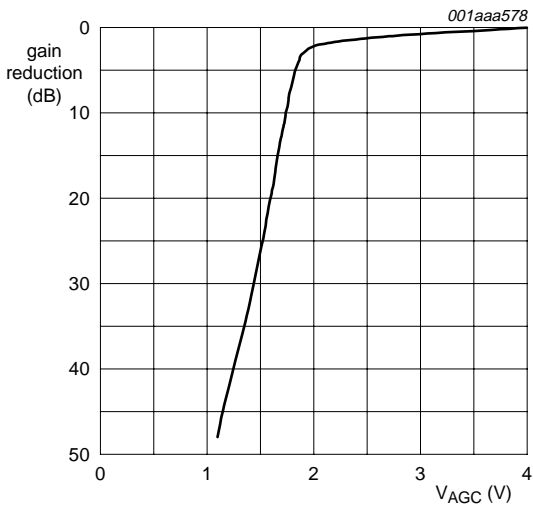

$V_{DS(b)} = 5$ V; $V_{GG} = 5$ V; $V_{DS(a)} = V_{G1-S(a)} = 0$ V;
 $R_{G1(b)} = 150$ k Ω (connected to V_{GG}); $f = 50$ MHz;
 $T_{amb} = 25$ °C; see [Figure 34](#).

Fig 27. Typical gain reduction as a function of AGC voltage.

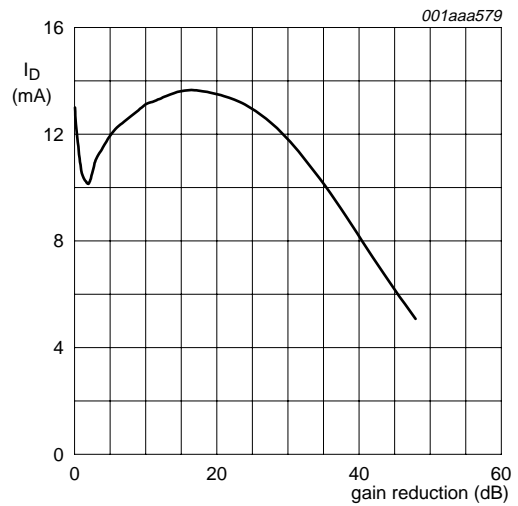

$V_{DS(b)} = 5$ V; $V_{GG} = 5$ V; $V_{DS(a)} = V_{G1-S(a)} = 0$ V;
 $R_{G1(b)} = 150$ k Ω (connected to V_{GG}); $f = 50$ MHz;
 $T_{amb} = 25$ °C; see [Figure 34](#).

Fig 28. Drain current as a function of gain reduction; typical values.

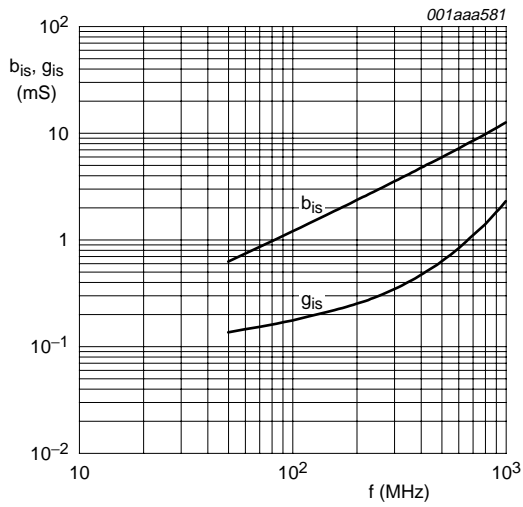

$V_{DS(b)} = 5\text{ V}; V_{G2-S} = 4\text{ V}; V_{DS(a)} = V_{G1-S(a)} = 0\text{ V}; I_{D(b)} = 13\text{ mA}.$

Fig 29. Input admittance as a function of frequency; typical values.

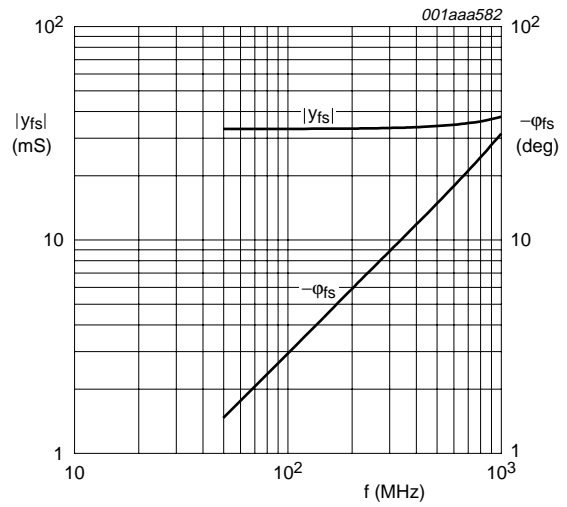

$V_{DS(b)} = 5\text{ V}; V_{G2-S} = 4\text{ V}; V_{DS(a)} = V_{G1-S(a)} = 0\text{ V}; I_{D(b)} = 13\text{ mA}.$

Fig 30. Forward transfer admittance and phase as a function of frequency; typical values.

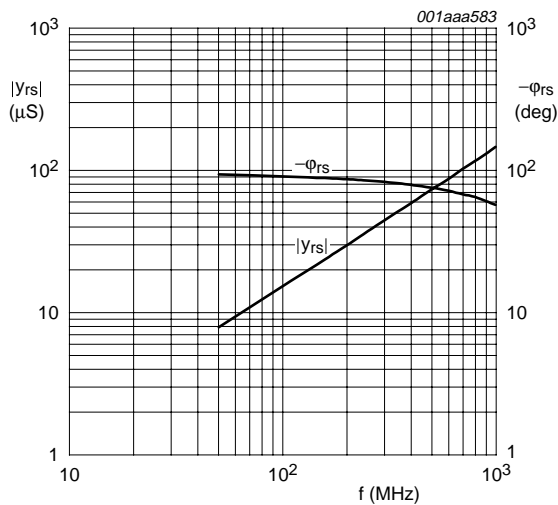

$V_{DS(b)} = 5\text{ V}; V_{G2-S} = 4\text{ V}; V_{DS(a)} = V_{G1-S(a)} = 0\text{ V}; I_{D(b)} = 13\text{ mA}.$

Fig 31. Reverse transfer admittance and phase as a function of frequency; typical values.

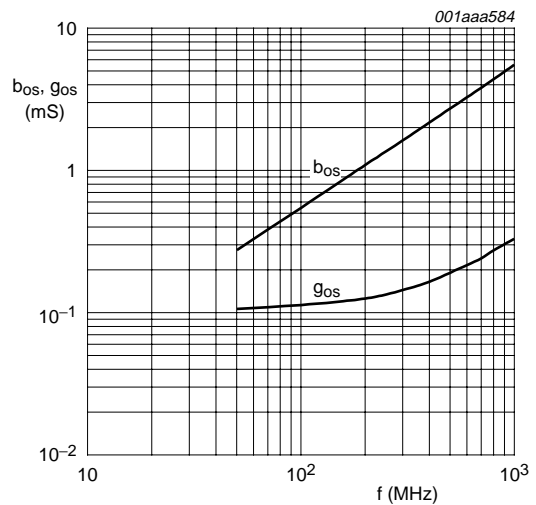

$V_{DS(b)} = 5\text{ V}; V_{G2-S} = 4\text{ V}; V_{DS(a)} = V_{G1-S(a)} = 0\text{ V}; I_{D(b)} = 13\text{ mA}.$

Fig 32. Output admittance as a function of frequency; typical values.

8.2.2 Scattering parameters for amplifier b

Table 12: Scattering parameters for amplifier b

$V_{DS(b)} = 5\text{ V}$; $V_{G2-S} = 4\text{ V}$; $I_{D(b)} = 13\text{ mA}$; $V_{DS(a)} = 0\text{ V}$; $V_{G1-S(a)} = 0\text{ V}$; $T_{amb} = 25\text{ }^{\circ}\text{C}$.

f (MHz)	S ₁₁		S ₂₁		S ₁₂		S ₂₂	
	Magnitude ratio	Angle (deg)	Magnitude ratio	Angle (deg)	Magnitude ratio	Angle (deg)	Magnitude ratio	Angle (deg)
50	0.986	-3.66	3.26	175.93	0.0008	84.23	0.988	-1.65
100	0.982	-7.01	3.24	172.04	0.0015	84.91	0.988	-3.27
200	0.975	-13.71	3.22	164.24	0.0029	83.96	0.986	-6.50
300	0.966	-20.36	3.19	156.53	0.0042	82.86	0.984	-9.69
400	0.955	-27.04	3.15	148.86	0.0055	81.88	0.982	-12.88
500	0.943	-33.62	3.10	141.24	0.0066	80.92	0.978	-16.07
600	0.927	-40.16	3.05	133.70	0.0076	80.15	0.975	-19.21
700	0.909	-46.70	2.99	126.13	0.0086	79.68	0.972	-22.35
800	0.891	-52.07	2.92	118.64	0.0094	78.28	0.968	-25.52
900	0.868	-59.48	2.84	111.09	0.0100	78.28	0.965	-28.65
1000	0.846	-65.86	2.77	103.58	0.0107	78.15	0.961	-31.85

8.2.3 Noise data for amplifier b

Table 13: Noise data for amplifier b

$V_{DS(b)} = 5\text{ V}$; $V_{G2-S} = 4\text{ V}$; $I_{D(b)} = 13\text{ mA}$; $V_{DS(a)} = 0\text{ V}$; $V_{G1-S(a)} = 0\text{ V}$; $T_{amb} = 25\text{ }^{\circ}\text{C}$.

f (MHz)	F _{min} (dB)	Γ _{opt}		r _n (Ω)
		ratio	(deg)	
400	1.3	0.695	13.11	0.694
800	1.4	0.674	32.77	0.674

9. Test information

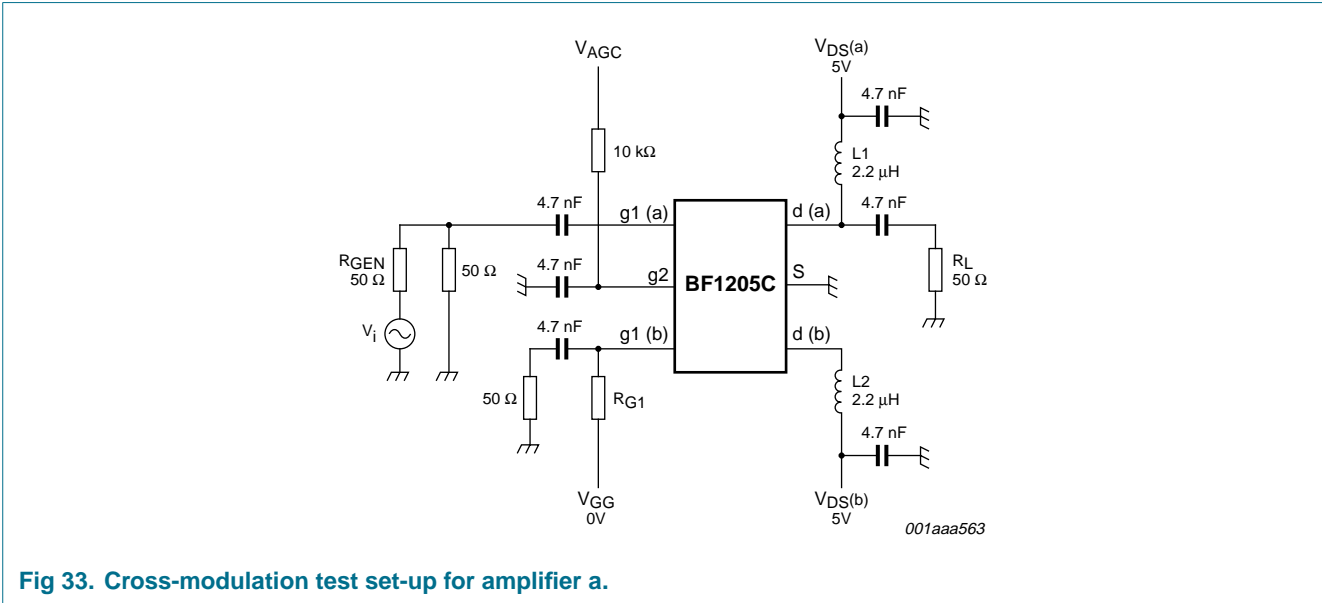

Fig 33. Cross-modulation test set-up for amplifier a.

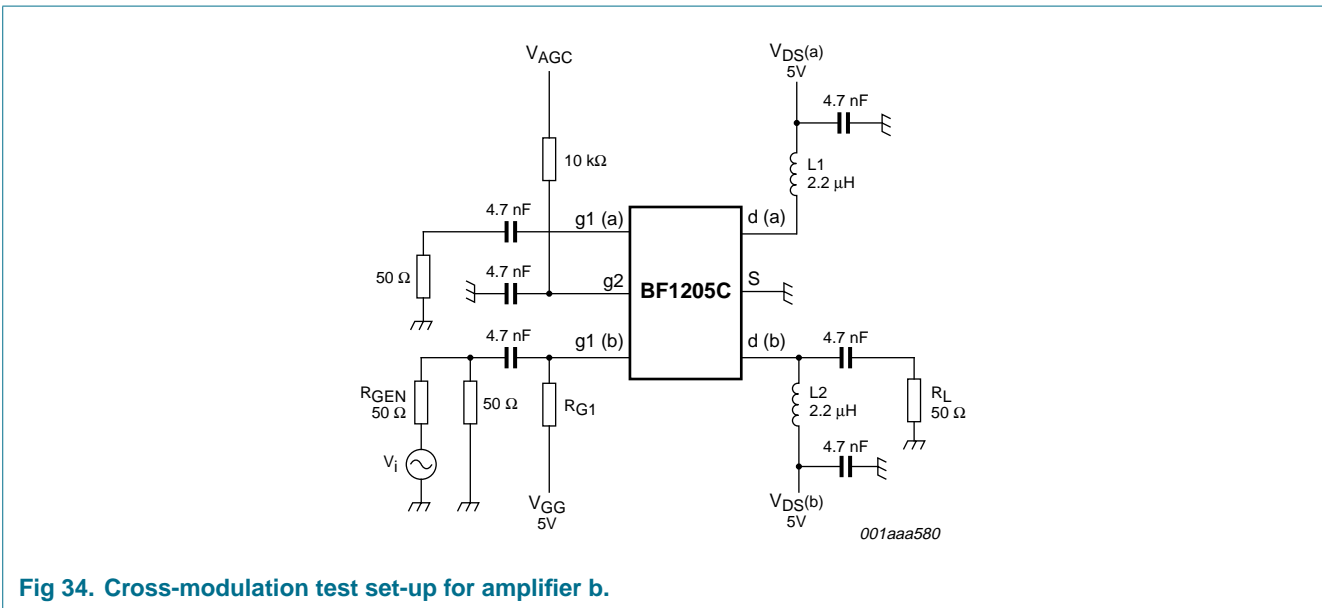

Fig 34. Cross-modulation test set-up for amplifier b.

10. Package outline

Plastic surface mounted package; 6 leads

SOT363

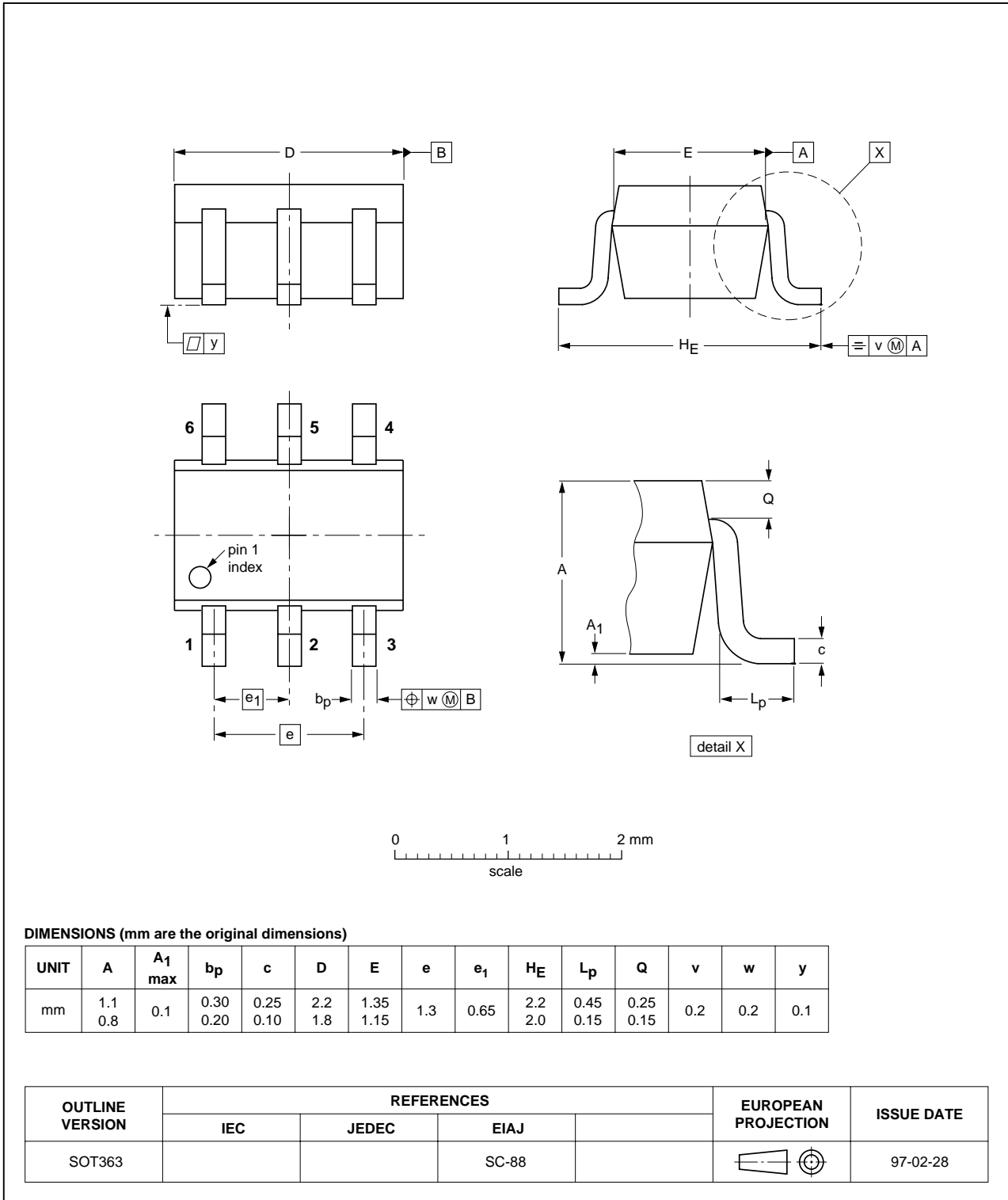

Fig 35. Package outline.

11. Revision history

Table 14: Revision history

Document ID	Release date	Data sheet status	Change notice	Order number	Supersedes
BF1205C_1	20040518	Product data	-	9397 750 13005	-

12. Data sheet status

Level	Data sheet status ^[1]	Product status ^[2] ^[3]	Definition
I	Objective data	Development	This data sheet contains data from the objective specification for product development. Philips Semiconductors reserves the right to change the specification in any manner without notice.
II	Preliminary data	Qualification	This data sheet contains data from the preliminary specification. Supplementary data will be published at a later date. Philips Semiconductors reserves the right to change the specification without notice, in order to improve the design and supply the best possible product.
III	Product data	Production	This data sheet contains data from the product specification. Philips Semiconductors reserves the right to make changes at any time in order to improve the design, manufacturing and supply. Relevant changes will be communicated via a Customer Product/Process Change Notification (CPCN).

[1] Please consult the most recently issued data sheet before initiating or completing a design.

[2] The product status of the device(s) described in this data sheet may have changed since this data sheet was published. The latest information is available on the Internet at URL <http://www.semiconductors.philips.com>.

[3] For data sheets describing multiple type numbers, the highest-level product status determines the data sheet status.

13. Definitions

Short-form specification — The data in a short-form specification is extracted from a full data sheet with the same type number and title. For detailed information see the relevant data sheet or data handbook.

Limiting values definition — Limiting values given are in accordance with the Absolute Maximum Rating System (IEC 60134). Stress above one or more of the limiting values may cause permanent damage to the device. These are stress ratings only and operation of the device at these or at any other conditions above those given in the Characteristics sections of the specification is not implied. Exposure to limiting values for extended periods may affect device reliability.

Application information — Applications that are described herein for any of these products are for illustrative purposes only. Philips Semiconductors make no representation or warranty that such applications will be suitable for the specified use without further testing or modification.

14. Disclaimers

Life support — These products are not designed for use in life support appliances, devices, or systems where malfunction of these products can reasonably be expected to result in personal injury. Philips Semiconductors customers using or selling these products for use in such applications do so at their own risk and agree to fully indemnify Philips Semiconductors for any damages resulting from such application.

Right to make changes — Philips Semiconductors reserves the right to make changes in the products - including circuits, standard cells, and/or software - described or contained herein in order to improve design and/or performance. When the product is in full production (status 'Production'), relevant changes will be communicated via a Customer Product/Process Change Notification (CPCN). Philips Semiconductors assumes no responsibility or liability for the use of any of these products, conveys no license or title under any patent, copyright, or mask work right to these products, and makes no representations or warranties that these products are free from patent, copyright, or mask work right infringement, unless otherwise specified.

15. Contact information

For additional information, please visit: <http://www.semiconductors.philips.com>

For sales office addresses, send an email to: sales.addresses@www.semiconductors.philips.com

16. Contents

1	Product profile	1
1.1	General description.	1
1.2	Features	1
1.3	Applications	1
1.4	Quick reference data.	2
2	Pinning information	2
3	Ordering information	3
4	Marking	3
5	Limiting values	3
6	Thermal characteristics	3
7	Static characteristics	4
8	Dynamic characteristics	5
8.1	Dynamic characteristics for amplifier a	5
8.1.1	Graphs for amplifier a	6
8.1.2	Scattering parameters for amplifier a	10
8.1.3	Noise data for amplifier a	10
8.2	Dynamic characteristics for amplifier b	11
8.2.1	Graphs for amplifier b	12
8.2.2	Scattering parameters for amplifier b	17
8.2.3	Noise data for amplifier b	17
9	Test information	18
10	Package outline	19
11	Revision history	20
12	Data sheet status	21
13	Definitions	21
14	Disclaimers	21
15	Contact information	21



© Koninklijke Philips Electronics N.V. 2004

All rights are reserved. Reproduction in whole or in part is prohibited without the prior written consent of the copyright owner. The information presented in this document does not form part of any quotation or contract, is believed to be accurate and reliable and may be changed without notice. No liability will be accepted by the publisher for any consequence of its use. Publication thereof does not convey nor imply any license under patent- or other industrial or intellectual property rights.

Date of release: 18 May 2004
Document order number: 9397 750 13005

Published in The Netherlands