



## Dual Output Mixed Voltage, BCP Models

5V and 3.3V, "Half-Brick"  
75 Watt, DC/DC Converters

### Features

- Independent 5V and 3.3V outputs
- Each output fully regulated
- No minimum load requirements
- Up to 15 Amps per output
- 75 Watts total output power
- Standard "half-brick" package
- UL1950, EN60950 and VDE safety approvals (BASIC insulation)
- Fully isolated, 1500Vdc guaranteed
- 18-36V or 36-75V input ranges
-  mark available (75V-input models)
- Input under and overvoltage shutdown
- Continuous short-circuit protection
- Thermal shutdown

As your new, mixed-logic (5V and 3.3V) design evolves and your current requirements change, your new DC/DC converter will not. DATEL's BCP-5/15-3.3/15-D24 (18-36V input) and BCP-5/15-3.3/15-D48 (36-75V input) are fully isolated DC/DC converters providing both 5V and 3.3V outputs. Housed in standard "half-brick" packages (2.3" x 2.4" x 0.525"), the BCP's can support any combination of 5V and 3.3V loading up to a combined total of 15 Amps. Both outputs are fully isolated (1500Vdc) and independently line ( $\pm 0.2\%$ ) and load ( $\pm 0.5\%$  and  $\pm 0.6\%$ ) regulated.

Both BCP models feature input pi filters, input undervoltage and overvoltage shut-down, input reverse-polarity protection, output overvoltage protection, current limiting, and thermal shutdown. Each has an on/off control function, and the two output voltages can be trimmed independently.

BCP Model DC/DC's deliver low noise (50mVp-p), high efficiency (87%) and are fully specified for  $-40$  to  $+100^{\circ}\text{C}$  operation. Utilization of metal baseplate technology with threaded inserts permits easy heat-sink attachment and/or pcb mounting. These devices meet IEC950, UL1950, EN60950 and VDE safety standards, including BASIC insulation requirements. CB reports are available on request. "D48" models are CE marked (meet the requirements of LVD).

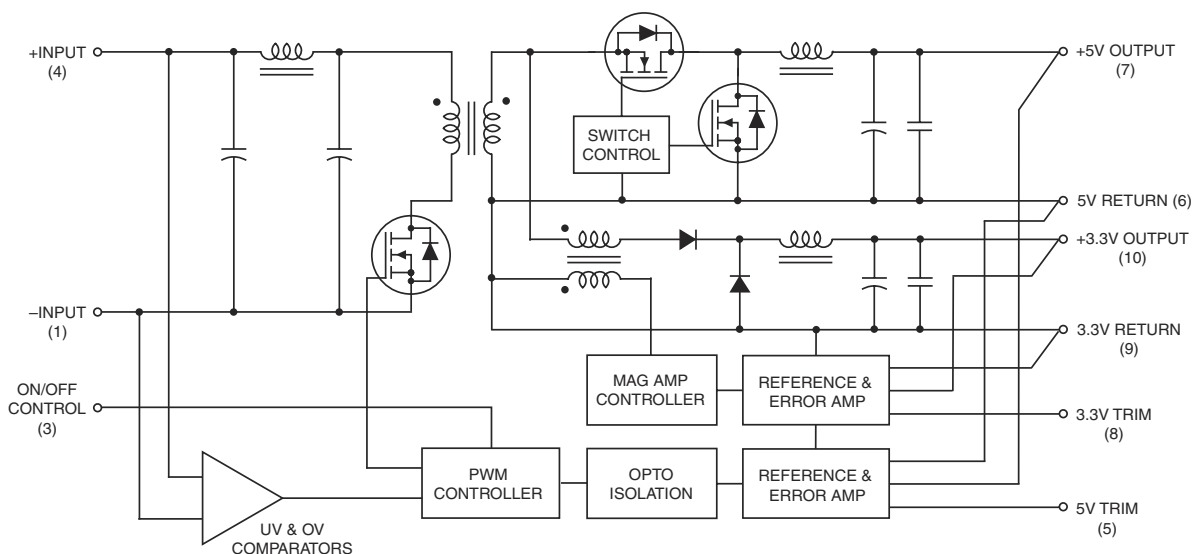

Figure 1. Simplified Schematic

**Performance Specifications and Ordering Guide <sup>①</sup>**

Model	Output						Input			Efficiency <sup>⑥</sup>		Package (Case, Pinout)
	V <sub>OUT</sub> (Volts)	I <sub>OUT</sub> <sup>⑤</sup> (Amps)	R/N (mVp-p)		Regulation (Max.)		V <sub>IN</sub> Nom. (Volts)	Range (Volts)	I <sub>IN</sub> <sup>④</sup> (mA)	Min.	Typ.	
			Typ.	Max.	Line	Load <sup>③</sup>						
BCP-5/15-3.3/15-D24	5	15	50	100	±0.2%	±0.5%	24	18-36	215/3720	84%	87.2%	C19, P29
	3.3	15	50	100	±0.2%	±0.6%						
BCP-5/15-3.3/15-D48	5	15	50	100	±0.2%	±0.5%	48	36-75	125/1860	84%	88%	C19, P29
	3.3	15	50	100	±0.2%	±0.6%						

- ① Typical at T<sub>A</sub> = +25°C under nominal line voltage and balanced "full-load" (5V @ 7.5A, 3.3V @ 7.5A) conditions unless otherwise noted.
- ② Ripple/Noise (R/N) measured over a 20MHz bandwidth. All models are specified with 22µF, low-ESR, input capacitor and 10µF tantalum in parallel with 1µF ceramic output capacitors.
- ③ No load to 100% load, other output at no-load.
- ④ Nominal line voltage, no-load/5V at full-load condition.
- ⑤ Current from either output at maximum value, or both outputs to a combined total of 15 A.
- ⑥ 5V at full-load condition.

**PART NUMBER STRUCTURE**

**BCP-5/15-3.3/15-D24 N LX**

Dual Output/  
Standard Half-Brick Package

V<sub>1</sub> Nominal Output Voltage: 5 Volts

I<sub>1</sub> Maximum Output Current: 15A

V<sub>2</sub> Nominal Output Voltage: 3.3 Volts

I<sub>2</sub> Maximum Output Current: 15A

Optional Functions:  
See also last page

Input Voltage Range:

D24 = 18-36 Volts (24V nominal)

D48 = 36-75 Volts (48V nominal)

**Optional Functions**

- Blank** On/Off Control function (positive polarity) on pin 3
- N** On/Off Control function (negative polarity) on pin 3
- L1** Pin length: 0.110 in. (2.79mm) ±0.010
- L2** Pin length: 0.145 in. (3.68mm) ±0.010

Refer to last page for additional options

**MECHANICAL SPECIFICATIONS**

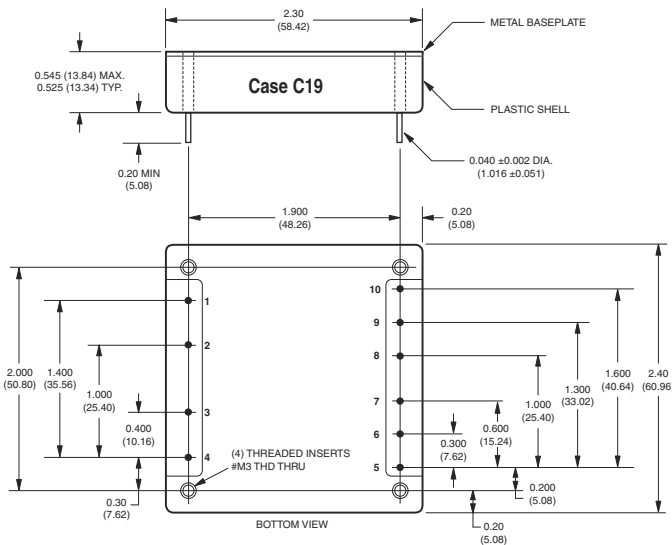

I/O Connections			
Pin	Function P29	Pin	Function P29
1	-Input	6	5V Return
2	Case (Baseplate)	7	+5V Output
3	On/Off Control	8	3.3V Trim
4	+Input	9	3.3V Return
5	5V Trim	10	+3.3V Output

**Optional Heat Sink (Part Number HS-CPLP2)**

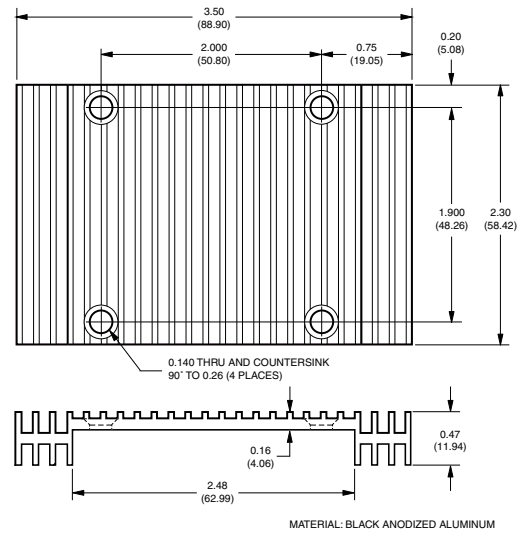

**Optional Heat Sink (Part Number HS-CP)**

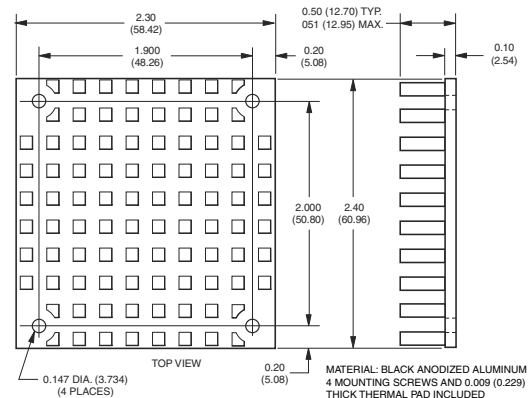

## Performance/Functional Specifications

Typical @ T<sub>A</sub> = +25°C under nominal line voltage, balanced "full-load" conditions, unless noted. ①

Input	
<b>Input Voltage Range:</b>	
D24 Models	18-36 Volts (24V nominal)
D48 Models	36-75 Volts (48V nominal)
<b>Overvoltage Shutdown:</b> ②	
D24 Models	37.5-40.5 Volts (39V typical)
D48 Models	78.8-87.0 Volts (83V typical)
<b>Start-Up Threshold:</b> ②	
D24 Models	15.5-18 Volts (16.5V typical)
D48 Models	33.5-36 Volts (34.4V typical)
<b>Undervoltage Shutdown:</b> ②	
D24 Models	14-16 Volts (15.3V typical)
D48 Models	30.5-33.5 Volts (31.8V typical)
<b>Input Current:</b>	
Normal Operating Conditions	See Ordering Guide
Minimum Input Voltage:	
D24 Models	5.02 Amps maximum
D48 Models	2.51 Amps maximum
Standby Mode:	
Off, OV, UV, Thermal Shutdown	17mA typical
<b>Input Reflected Ripple Current:</b>	
Source Impedance <0.1Ω	
22μF Low-ESR Capacitor	53mArms, 150mA <sub>p-p</sub> maximum
<b>Input Filter Type</b>	Pi (0.47pF - 4.7μH - 3μF)
<b>Reverse-Polarity Protection:</b> ②	
D24 Models	1 minute duration, 6A maximum
D48 Models	1 minute duration, 4A maximum
<b>On/Off Control:</b> (Pin 3) ② ③ ⑤	
D24 & D48 Models	On = open or 2.0 - +V <sub>IN</sub> , I <sub>IN</sub> = 50μA max. Off = 0-0.6V, I <sub>IN</sub> = 1mA max.
D24N & D48N" Models	On = 0-0.6V, I <sub>IN</sub> = 1mA max. Off = open or 2.0 - +V <sub>IN</sub> , I <sub>IN</sub> = 50μA max.
Output	
<b>V<sub>OUT</sub> Accuracy</b>	
5V Output	±2% maximum
3.3V Output	±2% maximum
<b>Minimum Loading Per Specification</b>	No load
<b>Ripple/Noise (20MHz BW)</b> ② ④	See Ordering Guide
<b>Line/Load Regulation</b>	See Ordering Guide
<b>Efficiency</b>	See Ordering Guide and Efficiency Curves
<b>Trim Range</b> ②	±10% independent
<b>Isolation Voltage:</b>	
Input-to-Output	1500Vdc minimum
Input-to-Case	1000Vdc minimum
Output-to-Case	1000Vdc minimum
<b>Isolation Capacitance</b>	470pF
<b>Isolation resistance</b>	100MΩ
<b>Current Limit Inception:</b> ②	
5V @ 98% V <sub>OUT</sub> (3.3V no-load)	16-20 Amps
3.3V @ 98% V <sub>OUT</sub> (5V no-load)	16-20 Amps
<b>Short Circuit Current:</b> ②	Constant current 25A, indefinite
<b>Temperature Coefficient</b>	±0.02% per °C
<b>Overvoltage Protection:</b> ②	Magnetic feedback, latching
5V Output	6.8 volts
3.3V Output	4.5Volts

Dynamic Characteristics	
<b>Dynamic Load Response:</b>	
5V (50-100% load step to 1% V <sub>OUT</sub> )	450μsec maximum
3.3V (50-100% load step to 1% V <sub>OUT</sub> )	450μsec maximum
<b>Start-Up Time:</b> ②	
V <sub>IN</sub> to V <sub>OUT</sub>	30msec maximum
On/Off to V <sub>OUT</sub>	20msec maximum
<b>Switching Frequency</b>	350kHz (±35kHz)
Environmental	
<b>MTBF</b>	Bellcore, ground fixed, controlled
D24 Models	1.49M hours (case @ 50°C)
D48 Models	1.72M hours (case @ 50°C)
<b>Operating Temperature (Ambient):</b>	
θ Case to Ambient, No Heatsink	6.8°C/Watt
Without Derating	-40 to +45°C (with heat sink)
With Derating	To +100°C (See Derating Curves)
<b>Case Temperature:</b>	
Maximum Allowable	+100°C
For Thermal Shutdown ②	+100°C minimum, +110°C maximum
<b>Storage Temperature</b>	-40 to +120°C
Physical	
<b>Dimensions</b>	2.3" x 2.4" x 0.525" (58.4 x 61 x 13.3mm)
<b>Case (Baseplate) Connection</b> ②	Pin 2
<b>Case/Pin Material</b>	Diallyl phthalate, UL94V-0 rated, aluminum baseplate; solder-tinned brass pins
<b>Weight</b>	4.2 ounces (118 grams)
<b>Primary to Secondary Insulation Level</b>	Basic

① Models are specified at "full load" (5V &amp; 3.3V @ 7.5A), with an external 22μF, low-ESR, input capacitor and 10μF tantalum in parallel with 1μF ceramic output capacitors.

② See Technical Notes for details.

③ Devices may be ordered with opposite polarity (pin 3 open = off). See Part Number Suffixes and Technical Notes for additional information.

④ Output noise may be further reduced with the installation of additional external output capacitors. See Technical Notes.

⑤ These signals must be referenced to the input return pin (-V<sub>IN</sub>).

⑥ Demonstrated MTBF available on request.

Absolute Maximum Ratings		
<b>Input Voltage:</b>		
Continuous:	D24 Models	40.5 Volts
	D48 Models	87 Volts
Transient (100msec):	D24 Models	50 Volts
	D48 Models	100 Volts
<b>Input Reverse-Polarity Protection</b> ②	Input Current must be limited. 1 minute duration. Fusing recommended.	
D24 Models	6 Amps	
D48 Models	4 Amps	
<b>Output Overvoltage Protection</b> ②		
3.3V Outputs	3.8 Volts, latching	
5V Outputs	6.2 Volts, latching	
<b>Output Current</b> ②	Current limited. Devices can withstand an indefinite output short circuit.	
<b>Storage Temperature</b>	-40 to +120°C	
<b>Lead Temperature (Soldering, 10 sec.)</b>	+300°C	
These are stress ratings. Exposure of devices to any of these conditions may adversely affect long-term reliability. Proper operation under conditions other than those listed in the Performance/Functional Specifications Table is not implied, nor recommended.		

## TECHNICAL NOTES

**5V & 3.3V Outputs>Returns**

The BCP Series outputs (pins 7 & 10) and returns (pins 6 & 9) are isolated from the +V<sub>IN</sub> and -V<sub>IN</sub> inputs (pins 4 & 1) via a transformer and opto-coupled transistors.

The +5V Return (pin 6) and +3.3V Return (pin 9) are connected internal to the DC/DC converter. Though the returns are common within the DC/DC converter, the regulating control loop for each output is sensed directly at its respective output and return pins. In order to maintain optimum regulation if ground plane is not used, it is critical that PC board layouts also return each output to its corresponding return pin.

**Filtering and Noise Reduction**

All BCP DC/DC Converters achieve their rated ripple and noise specifications using the external input and output capacitors specified in the Performance/Functional Specifications table. In critical applications, input/output noise may be further reduced by installing additional external I/O caps. Input capacitors should be selected for bulk capacitance, low ESR and high rms-ripple-current ratings. Output capacitors should be selected for low ESR and appropriate frequency response. All caps should have appropriate voltage ratings and be mounted as close to the converters as possible.

The most effective combination of external I/O capacitors will be a function of your particular load and layout conditions. Our Applications Engineers will be pleased to recommend potential solutions and can discuss the possibility of our modifying a device's internal filtering to meet your specific requirements. Contact our Applications Engineering Group for additional details.

**Input Fusing**

Certain applications and/or safety agencies may require the installation of fuses at the inputs of power conversion components. Fuses should also be used if the possibility of sustained, non-current-limited, input-voltage polarity reversals exists. For DATEL BCP DC/DC Converters, you should use slow-blow type fuses with values no greater than the following.

V <sub>IN</sub> Range	Fuse Value
"D24" Models	6 Amps
"D48" Models	4 Amps

Fuses should be installed in the +Input line.

**Input Overvoltage/Undervoltage Shutdown and Start-Up Threshold**

Under normal start-up conditions, devices will not begin to regulate until the ramping-up input voltage exceeds the Start-Up Threshold Voltage (35V for "D48" models). Once operating, devices will not turn off until the input voltage drops below the Undervoltage Shutdown limit (32V for "D48" models). Subsequent re-start will not occur until the input is brought back up to the Start-Up Threshold. This built-in hysteresis prevents any unstable on/off situations from occurring at a single voltage.

Input voltages exceeding the input overvoltage shutdown specification listed in the Performance/Functional Specifications will cause the device to shut-down. A built-in hysteresis (2V typical for "D24" models, 4V typical for "D48" models) will not allow the converter to restart until the input voltage is sufficiently reduced.

**Start-Up Time**

The V<sub>IN</sub> to V<sub>OUT</sub> start-up time is the interval between the time at which a ramping input voltage crosses the turn-on threshold point and the fully-loaded output voltage enters and remains within its specified accuracy band. Actual measured times will vary with input source impedance, external input capacitance, and the slew rate and final value of the input voltage as it appears to the converter.

The On/Off to V<sub>OUT</sub> start-up time assumes the converter has its nominal input voltage applied but is turned off via the On/Off Control. The specification defines the interval between the time at which the converter is turned on and the fully loaded output voltage enters and remains within its specified accuracy band.

**On/Off Control (Standard feature)**

The On/Off Control (pin 3) may be used for remote on/off operation. As shown in Figure 1A, the control pin is referenced to the -Input (pin 1) and will be pulled to a high state internally. The standard BCP converter (no suffix) is designed so that it is enabled when the control pin is left open and disabled when the control pin is pulled low (to less than +0.6V relative to -Input).

Dynamic control of the on/off function is best accomplished with a mechanical relay or an open-collector/open-drain drive circuit (optically isolated if appropriate). The drive circuit should be able to sink approximately 1mA for logic low.

The on/off control function is designed such that the converter can be disabled (pin 3 pulled low for no-suffix models) while input power is ramping up and then "released" once the input has stabilized.

For BCP converters configured with the negative-polarity option on the On/Off Control pin ("N" suffix added to part number), operation is opposite to that described above. The converter is disabled when the On/Off Control pin is left open and enabled when pulled low.

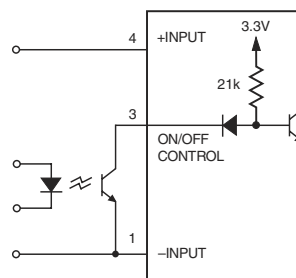

Figure 1A. No Suffix

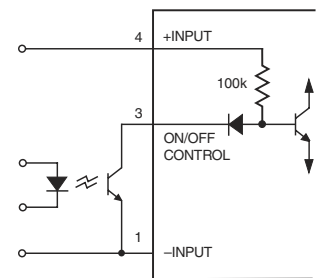

Figure 1B. "N" Suffix

**Output Overvoltage Protection**

Each voltage output of the BCP Series converter is independently monitored via an auxiliary winding in the output inductor. If the output voltage should rise to a level which could be damaging to the load circuitry (see Performance/Functional Specifications for limits), the overvoltage circuitry will power down the PWM controller and latch off the DC/DC converter. The device must now be restarted by powering cycling  $V_{IN}$ .

**Current Limiting**

When output current demands exceed the maximum output current rating by 107% to 133%, the DC/DC converter will go into a current limiting mode. In this condition the output voltage decreases proportionately as the output current increases, thereby maintaining a somewhat constant power dissipation—referred to as Power Limiting (see Figure 2). As the load approaches a short circuit, the output current will continue to increase until it reaches the rated Short Circuit Current limit.

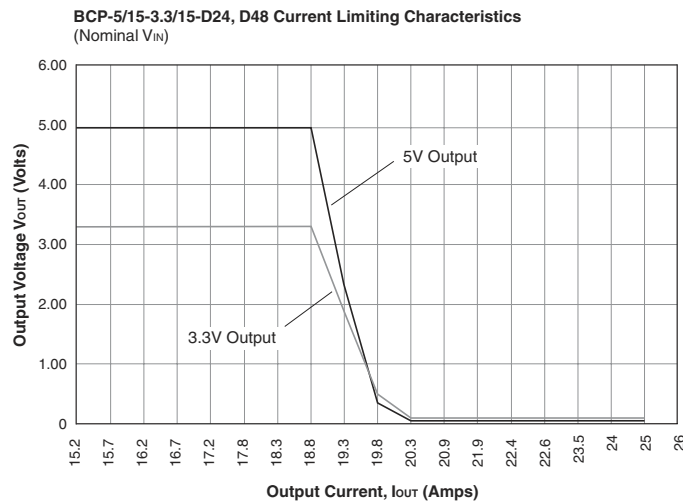

Figure 2. Current Limiting Characteristics

**Short Circuit Condition**

As described under "Current Limiting," when the BCP Series DC/DC converter output is subjected to a short circuit condition, the output current will remain at the Short Circuit Current limit. In this state there is negligible power dissipated in the load. Therefore, most of the input power is dissipated within the converter, causing the internal temperature to increase. If this condition persists, Thermal Shutdown will activate and shutdown the DC/DC converter. When the internal temperature is sufficiently decreased, the converter will self-start.

**Thermal Shutdown**

The BCP Series is equipped with Thermal Shutdown circuitry. If the internal temperature of the DC/DC converter rises above the designed operating temperature, a precision temperature sensor will power down the unit. When the internal temperature decreases below the threshold of the temperature sensor the unit will self-start.

**Input Reverse-Polarity Protection**

Upon applying a reverse-polarity voltage to the DC/DC converter, an internal diode will be forward biased and draw excessive current from the power source. Therefore, it is required that the input current be limited by either an appropriately rated input fuse or a current limited power source.

**Heat Sinks for BCP Series**

DATEL offers two standard heat sinks that can be mounted to the half-brick package to extend the converter's operating temperature range. Along with the standard 2.3" x 2.4" x 0.5" (HS-CP) heat sink, DATEL has designed a low-profile heat sink for height-restricted applications. This new heat sink (HS-CPLP2) is designed with radiant fins that extend 0.51" beyond either side of the 2.4" dimension of the BCP package. The convenience of this design is that the finned extensions protrude only 0.31" below the top surface of the DC/DC converter, allowing components with a profile height less than 0.215" to be mounted on the pc board below the heat sink. Therefore, while the surface area of the low-profile heat sink measures 2.3" x 3.5", pcb real estate is unaffected.

For optimum thermal performance in a natural convection application, the low-profile heat sink should be mounted with the fins vertically oriented. Both models are shipped with 0.009" self-adhesive thermal pad and mounting screws.

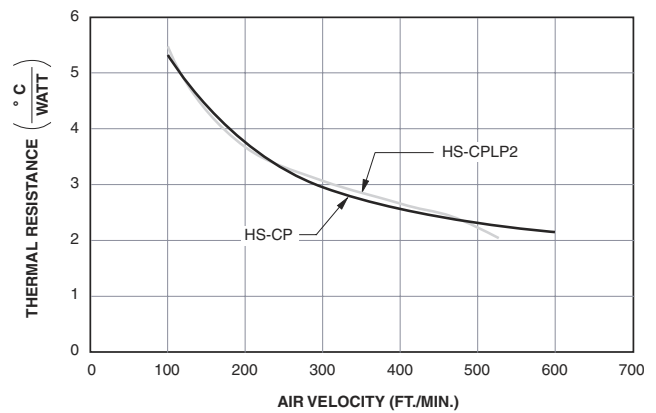

HS-CP and HS-CPLP2 Heat Sink Performance Vs. Air Flow (@ 10.5 Watts Power Dissipation)

**Output Trimming**

Both the 5V and 3.3V outputs of the BCP Series can be independently trimmed via a trimpot (Figure 3A) or a single fixed resistor as shown (Figures 3B & 3C). The trimpot can be used to determine the value of a single fixed resistor. A single fixed resistor can increase or decrease the output voltage depending on its connection. Fixed resistors should be metal-film types with absolute TCR's less than 100ppm/°C to ensure stability.

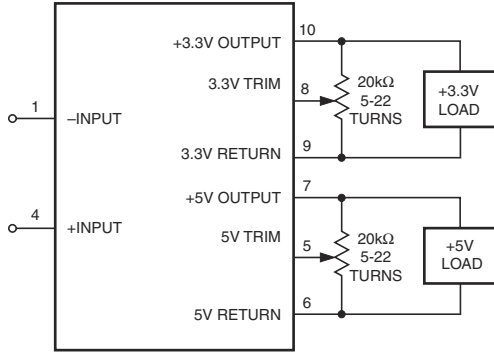

**Figure 3A. Trim Connections Using a Trimpot**

A resistor connected from the Trim Pin (pin 5 for 5V trim, pin 8 for 3.3V trim) to the appropriate Return (pin 6 for 5V trim, pin 9 for 3.3V trim) will increase the output voltage.

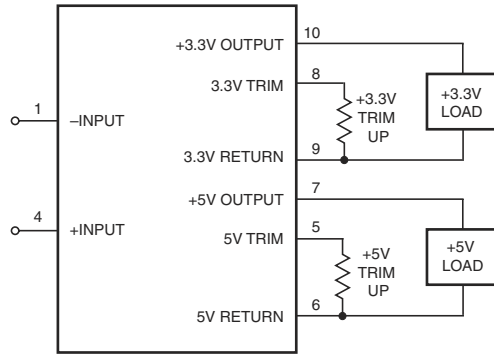

**Figure 3B. Increase Output Voltage Trim Connections Using a Fixed Resistor**

A single resistor connected from the Trim Pin (pin 5 for 5V trim, pin 8 for 3.3V trim) to its appropriate +Output (pin 7 for 5V trim, pin 10 for 3.3V trim) will decrease the output voltage.

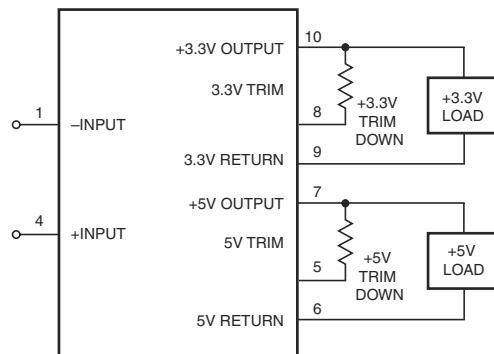

**Figure 3C. Decrease Output Voltage Trim Connections Using a Fixed Resistor**

Table 1 shows the typical fixed Trim Resistor values for output voltage changes of 0 through 10%. Trim adjustment greater than 10% can have an adverse affect on the converter's performance and is not recommended.

	3.3V Trim Down	3.3V Trim Up	5V Trim Down	5V Trim Up
0%	–	–	–	–
1%	47.81k	27.93k	189.75k	61.68k
2%	22.32k	12.78k	91.06k	28.34k
3%	13.82k	7.73k	58.17k	17.23k
4%	9.57k	5.21k	41.72k	11.68k
5%	7.02k	3.69k	31.85k	8.34k
6%	5.320k	2.68k	25.27k	6.12k
7%	4.10k	1.96k	20.57k	4.53k
8%	3.19k	1.42k	17.05k	3.34k
9%	2.48k	1.00k	14.31k	2.42k
10%	1.92k	0.66k	12.12k	1.68k

**Table 1. Percentage of Output Voltage Change vs Trim Resistor Value (Ohms)**

The following equations mathematically depict:  
Output Voltage for a given Trim Resistor  
Trim Resistor for a given Output Voltage

**5 Volt Trim Up**

$$V_o = 5.0 + \left( \frac{1}{0.30R_{TUP}(k\Omega) + 1.5} \right) \quad R_{TUP}(k\Omega) = \left( \frac{1}{(0.3V_o) - 1.50} \right) - 4.99$$

**5 Volt Trim Down**

$$V_o = 1.25 \left[ \frac{1.14}{0.38 + \left( \frac{1}{R_{TDOWN}(k\Omega) + 4.99} \right)} + 1 \right] \quad R_{TDOWN}(k\Omega) = \left[ \frac{1}{\left( \frac{1.14}{(0.8V_o) - 1} \right) - 0.38} \right] - 4.99$$

**3.3 Volt Trim Up**

$$V_o = 3.30 + \left( \frac{1}{R_{TUP}(k\Omega) + 2.37} \right) \quad R_{TUP}(k\Omega) = \left( \frac{1}{V_o - 3.3} \right) - 2.37$$

**3.3 Volt Trim Down**

$$V_o = 1.23 \left[ \frac{2.07}{1.23 + \left( \frac{1}{R_{TDOWN}(k\Omega) + 2.37} \right)} + 1 \right] \quad R_{TDOWN}(k\Omega) = \left[ \frac{1}{\left( \frac{2.07}{\left( \frac{V_o}{1.23} - 1 \right)} - 1.23 \right)} \right] - 2.37$$

Note: Resistor values are in kΩ. Accuracy of adjustment is subject to tolerances of resistor values and factory-adjusted output accuracy.  
V<sub>o</sub> = desired output voltage.

**Case Connection**

BCP DC/DC's do not have their metal baseplate connected to one of the input pins. The "uncommitted" baseplate is connected to pin 2 which, depending upon your system configuration, should be connected to either +Input (pin 4), -Input (pin 1), Output Returns (pins 6 & 9), or earth ground.

**Typical Performance Curves**

**D24 Model**

**Output Ripple and Noise (PARD)**

(VIN = 24V, 5V@7.5A, 3.3V @ 7.5A, external 10μF || 1μF output capacitors.)

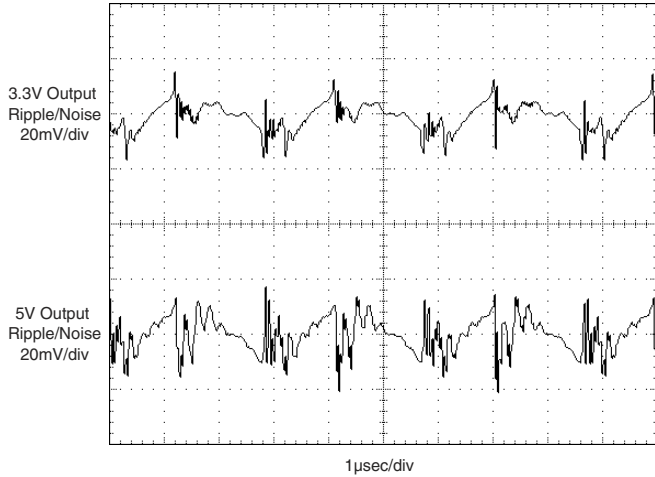

**5V Output Full-Load to Half-Load Transient Response**

(VIN = 24V, 3.3V@ 0A, external 10μF || 1μF output capacitors.)

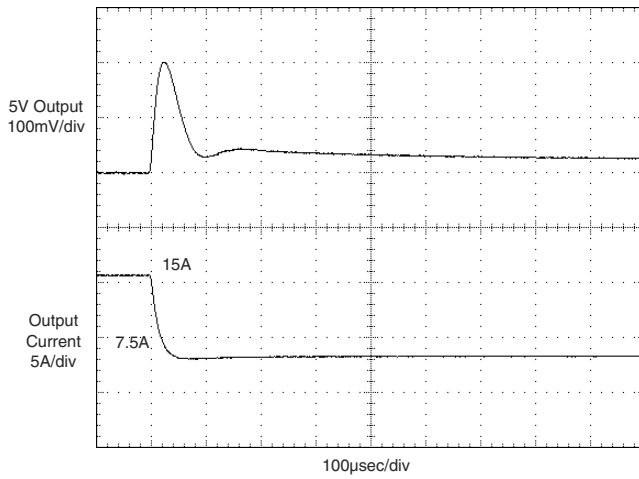

**5V Output Half-Load to Full-Load Transient Response**

(VIN = 24V, 3.3V@ 0A, external 10μF || 1μF output capacitors.)

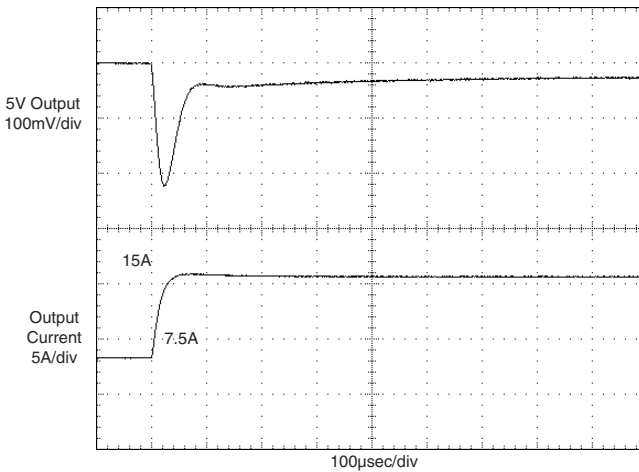

**D48 Model**

**Output Ripple and Noise (PARD)**

(VIN = 48V, 5V@7.5A, 3.3V @ 7.5A, external 10μF || 1μF output capacitors.)

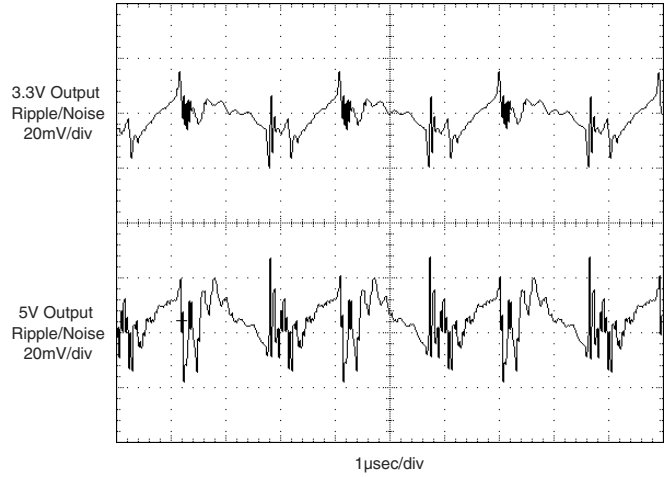

**5V Output Full-Load to Half-Load Transient Response**

(VIN = 48V, 3.3V@ 0A, external 10μF || 1μF output capacitors.)

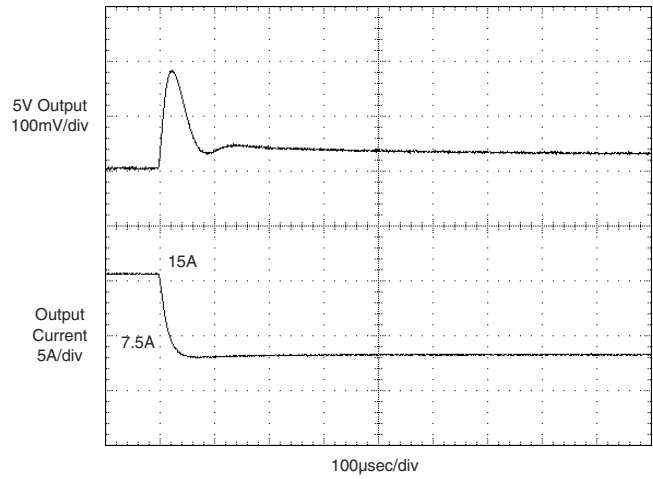

**5V Output Half-Load to Full-Load Transient Response**

(VIN = 48V, 3.3V@ 0A, external 10μF || 1μF output capacitors.)

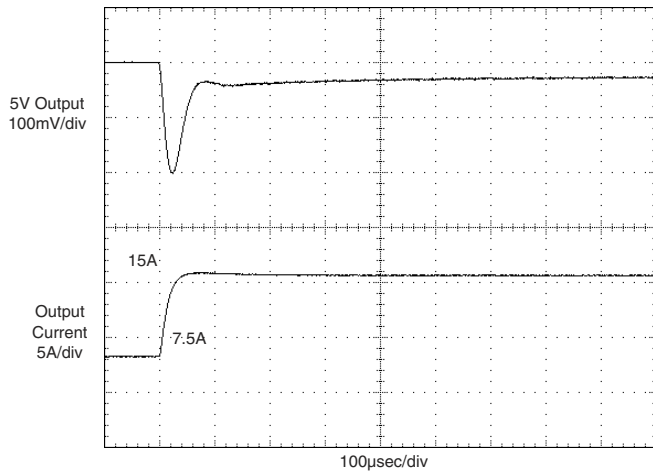

**Typical Performance Curves**

**D24 Model**

**3.3V Output Full-Load to Half-Load Transient Response**  
(VIN = 24V, 5V @ 0A, external 10 $\mu$ F || 1 $\mu$ F output capacitors.)

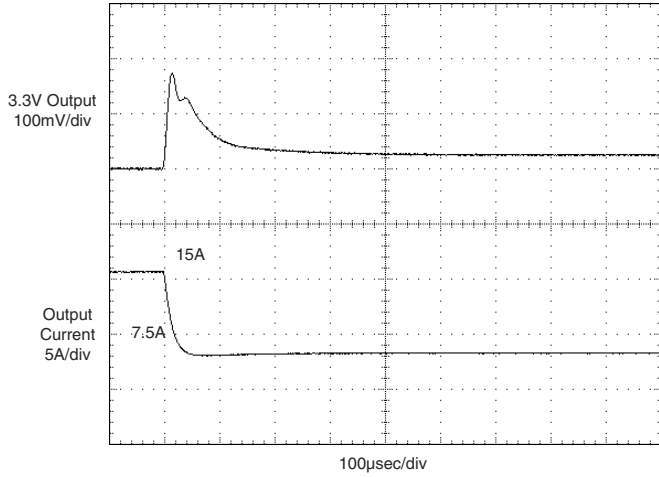

**D48 Model**

**3.3V Output Full-Load to Half-Load Transient Response**  
(VIN = 48V, 5V @ 0A, external 10 $\mu$ F || 1 $\mu$ F output capacitors.)

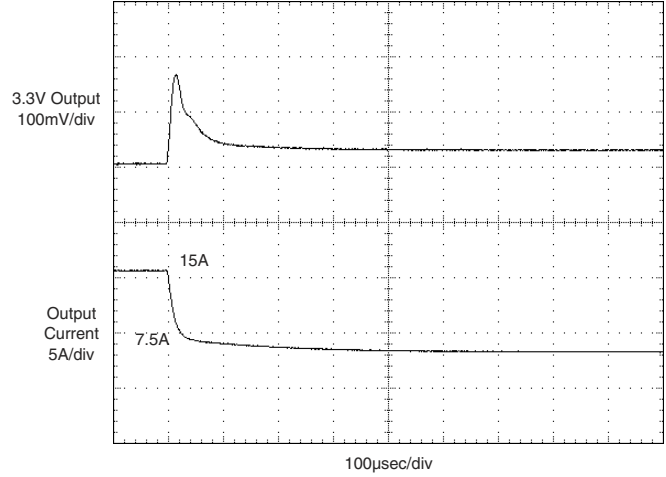

**3.3V Output Half-Load to Full-Load Transient Response**  
(VIN = 24V, 5V @ 0A, external 10 $\mu$ F || 1 $\mu$ F output capacitors.)

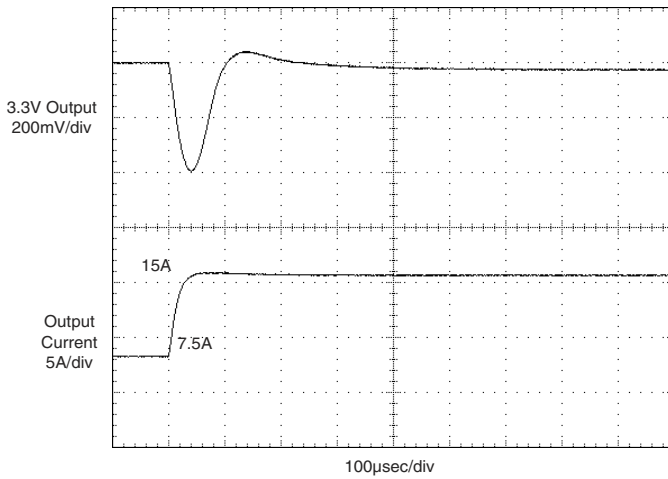

**3.3V Output Half-Load to Full-Load Transient Response**  
(VIN = 48V, 5V @ 0A, external 10 $\mu$ F || 1 $\mu$ F output capacitors.)

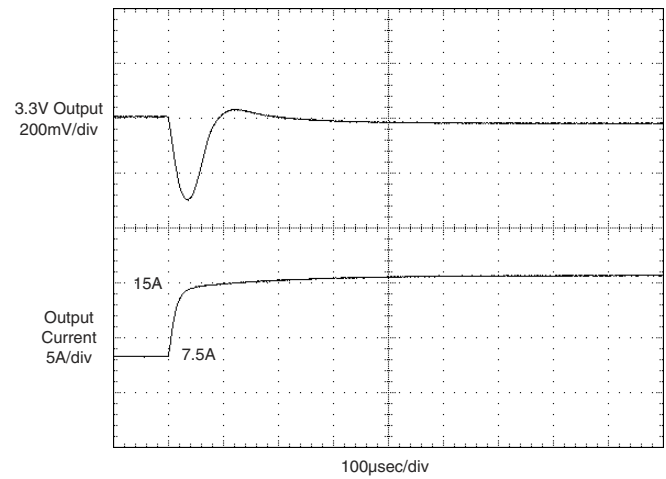

**Input Ripple Current**

(VIN = 24V, 5V @ 15A, 3.3V @ 0A, external 22 $\mu$ F low-ESR input capacitor.)

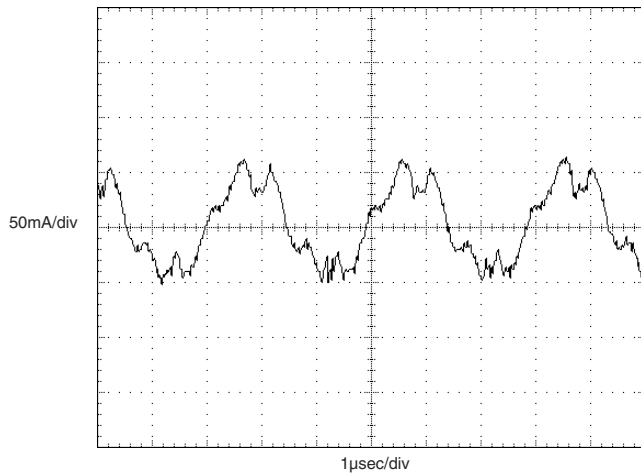

**Input Ripple Current**

(VIN = 48V, 5V @ 15A, 3.3V @ 0A, external 22 $\mu$ F low-ESR input capacitor.)

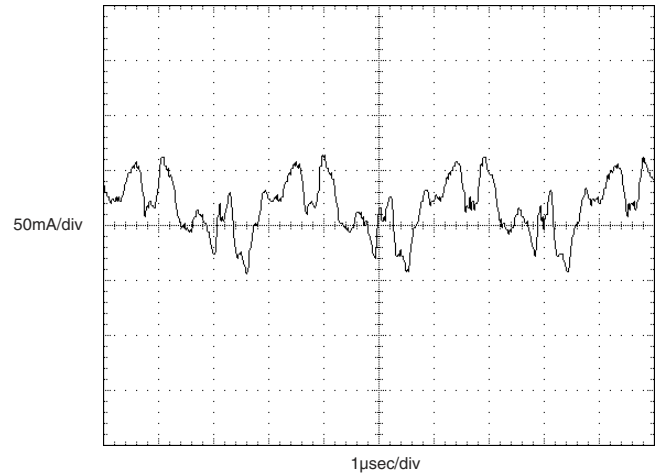



Typical Performance Curves

D24 Model

Input Ripple Current

(VIN = 24V, 5V @ 0A, 3.3V @ 15A, external 22µF low-ESR input capacitor.)

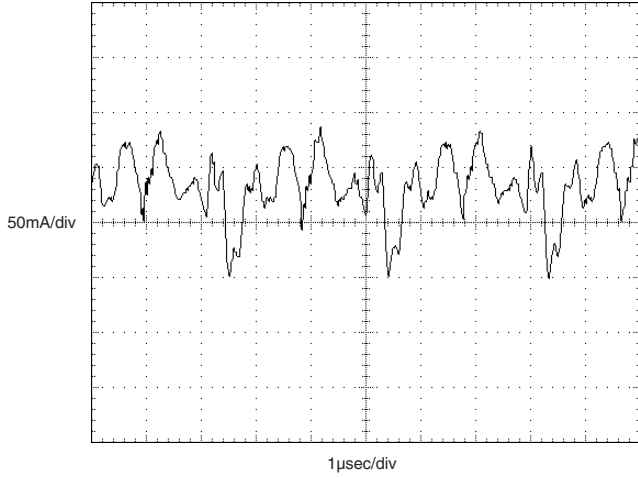

Start-Up from Remote On/Off Control

(VIN = 24V, 5V @ 7.5A, 3.3V @ 7.5A, external 10µF || 1µF output capacitors.)

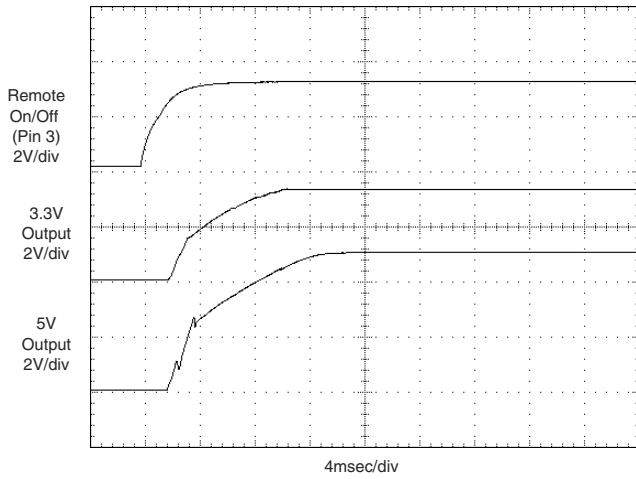

Start-Up from VIN

(VIN = 24V, 5V @ 7.5A, 3.3V @ 7.5A, external 10µF || 1µF output capacitors.)

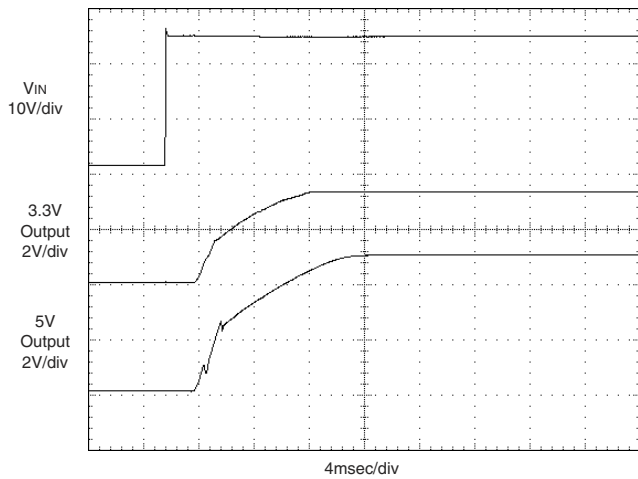

D48 Model

Input Ripple Current

(VIN = 48V, 5V @ 0A, 3.3V @ 15A, external 22µF low-ESR input capacitor.)

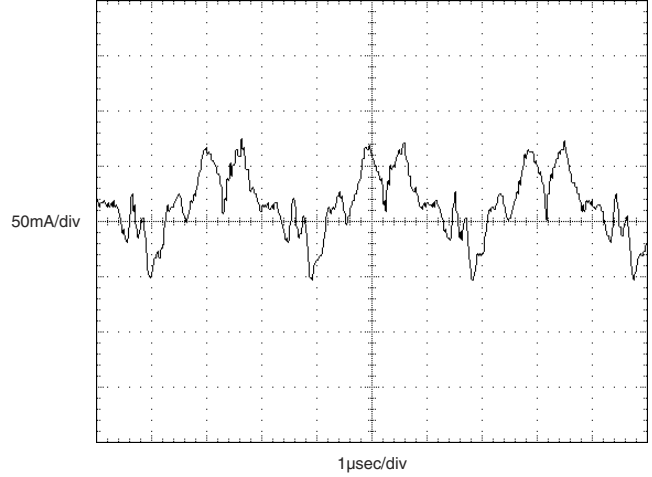

Start-Up from Remote On/Off Control

(VIN = 48V, 5V @ 7.5A, 3.3V @ 7.5A, external 10µF || 1µF output capacitors.)

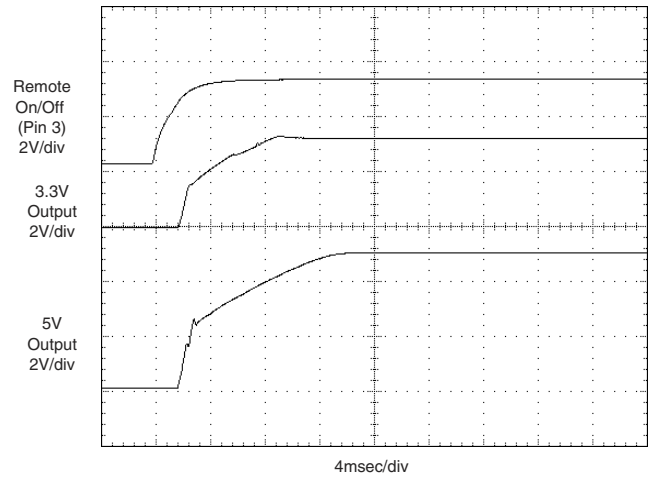

Start-Up from VIN

(VIN = 48V, 5V @ 7.5A, 3.3V @ 7.5A, external 10µF || 1µF output capacitors.)

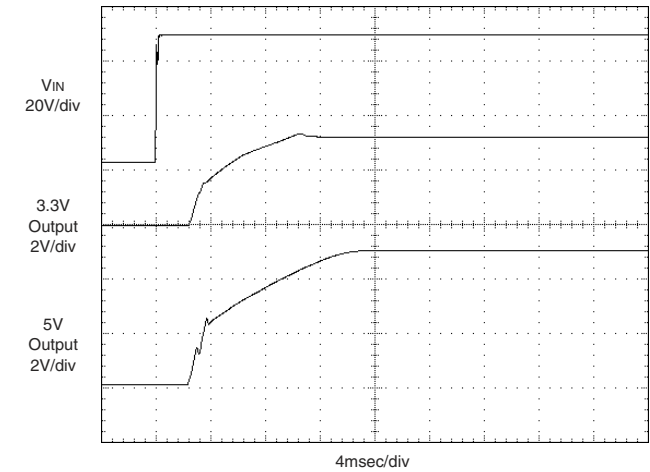

**Typical Performance Curves**

**D24 Model**

**Output Power vs. Ambient Temperature**  
(Without heat sink, 5V Output, 3.3V @ 0A.)

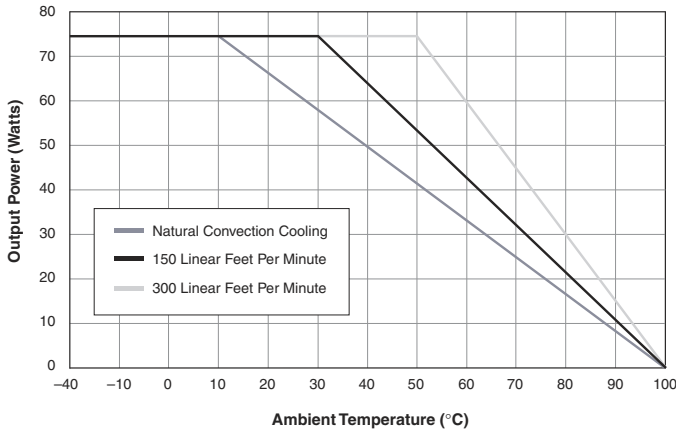

**Output Power vs. Ambient Temperature**  
(With HS-CP heat sink, 5V Output, 3.3V @ 0A.)

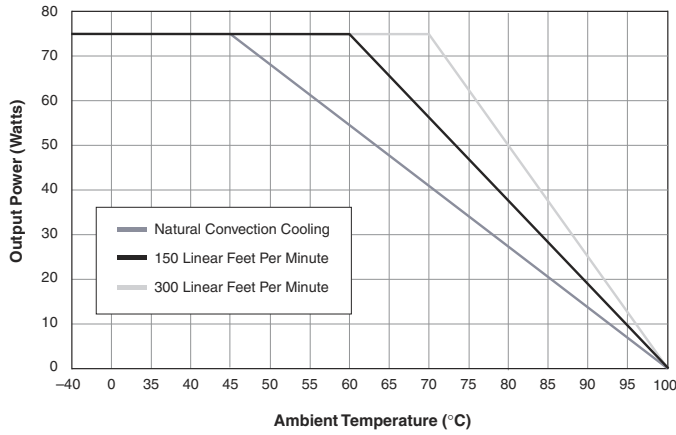

**Output Power vs. Ambient Temperature**  
(Without heat sink, 3.3V Output, 5V @ 0A.)

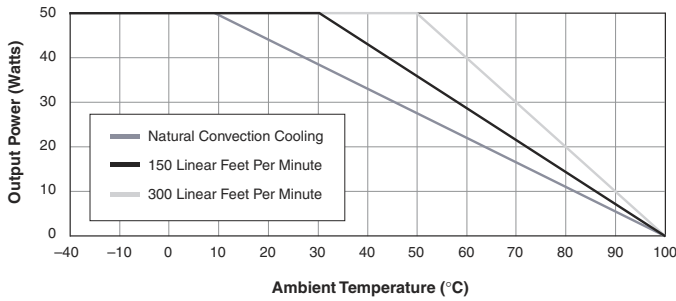

**Output Power vs. Ambient Temperature**  
(With HS-CP heat sink, 3.3V Output, 5V @ 0A.)

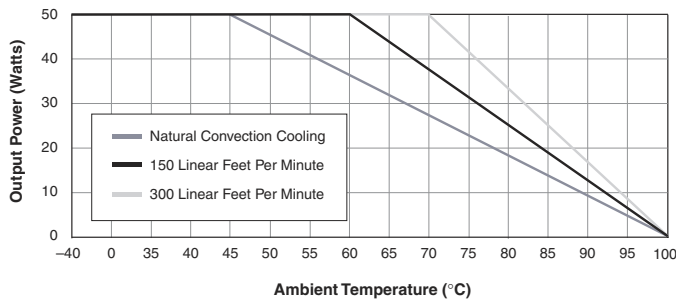

**D48 Model**

**Output Power vs. Ambient Temperature**  
(Without heat sink, 5V Output, 3.3V @ 0A.)

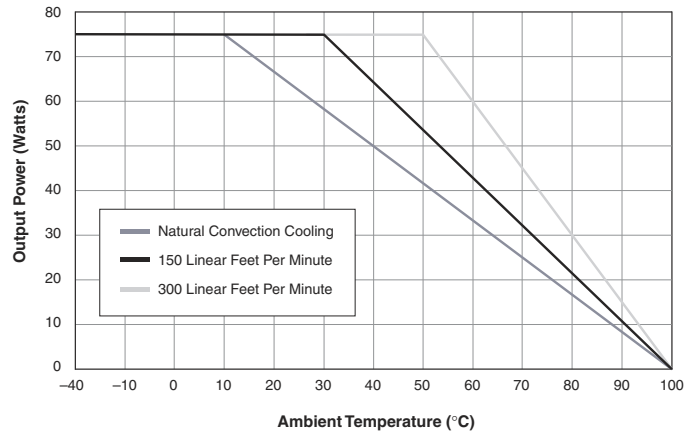

**Output Power vs. Ambient Temperature**  
(With HS-CP heat sink, 5V Output, 3.3V @ 0A.)

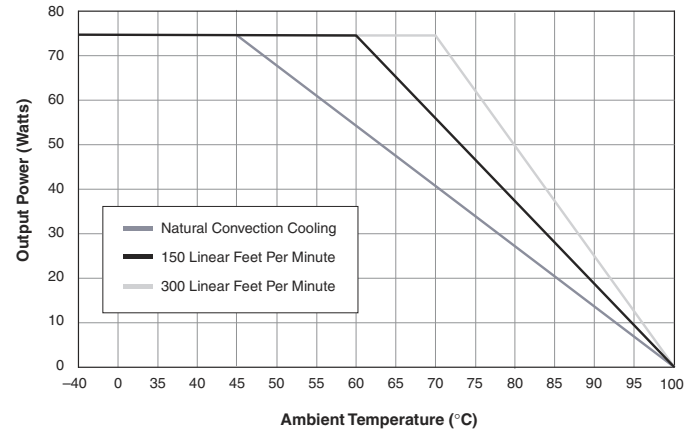

**Output Power vs. Ambient Temperature**  
(Without heat sink, 3.3V Output, 5V @ 0A.)

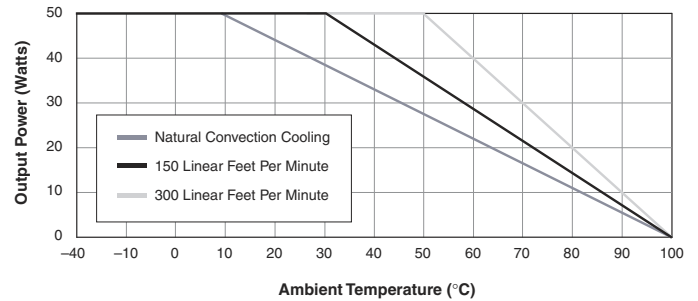

**Output Power vs. Ambient Temperature**  
(With HS-CP heat sink, 3.3V Output, 5V @ 0A.)

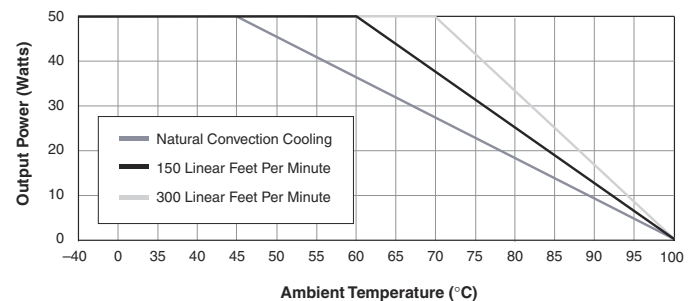

Typical Performance Curves

D24 Model

5V Efficiency vs. Load  
(+3.3V Output @ 0 Amps.)

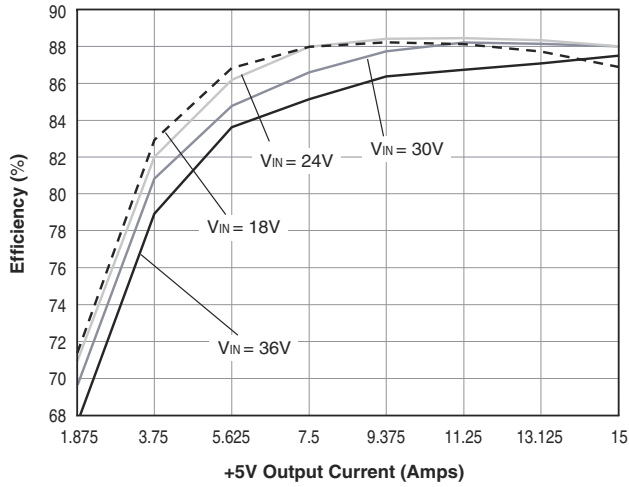

3.3V Efficiency vs. Load  
(+5V Output @ 0 Amps.)

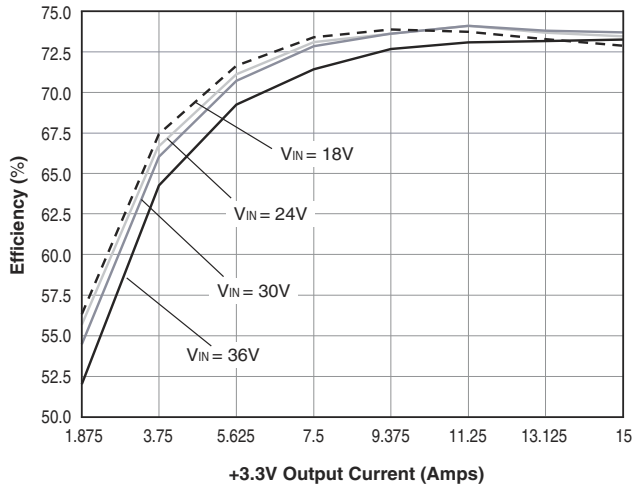

Overall Efficiency vs. Line and Load

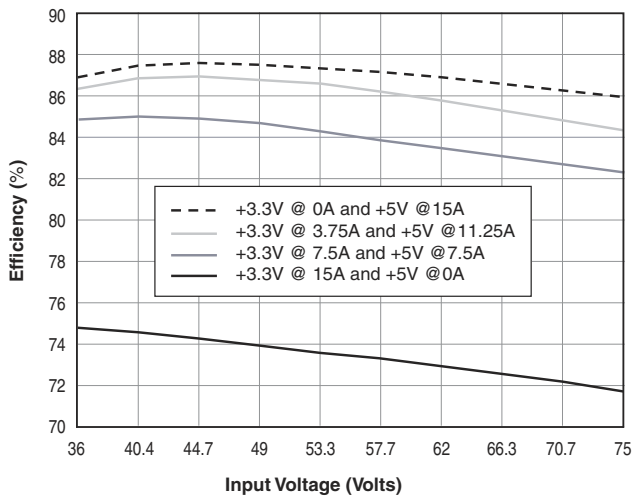

D48 Model

5V Efficiency vs. Load  
(+3.3V Output @ 0 Amps.)

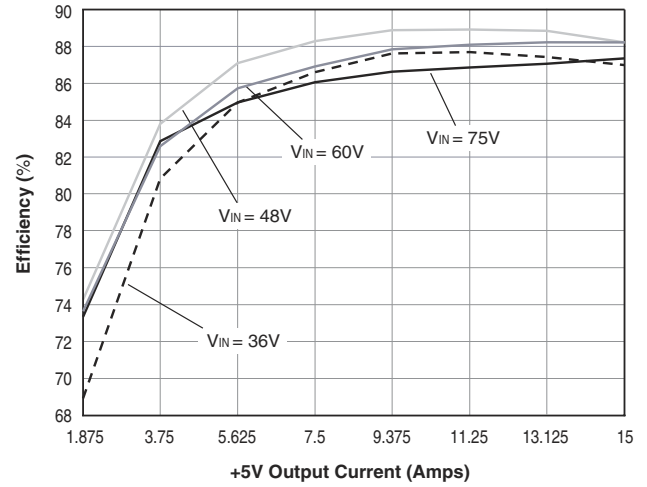

3.3V Efficiency vs. Load  
(+5V Output @ 0 Amps.)

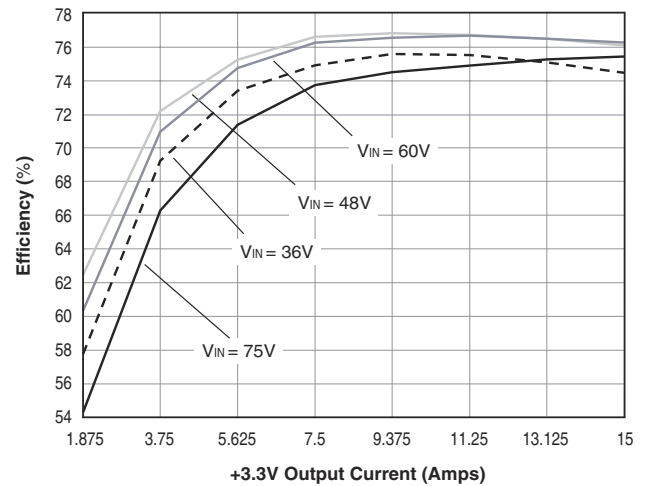

Overall Efficiency vs. Line and Load

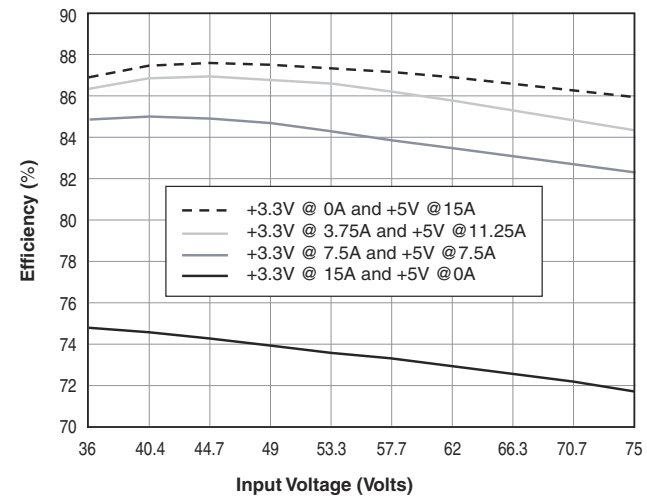

**Typical Performance Curves**

**D24 Model**

**Output Ripple and Noise (PARD) vs. Input Voltage**  
(One output @ 15A, other output @ 0A, PARD measured on loaded output, 20MHz bandwidth.)

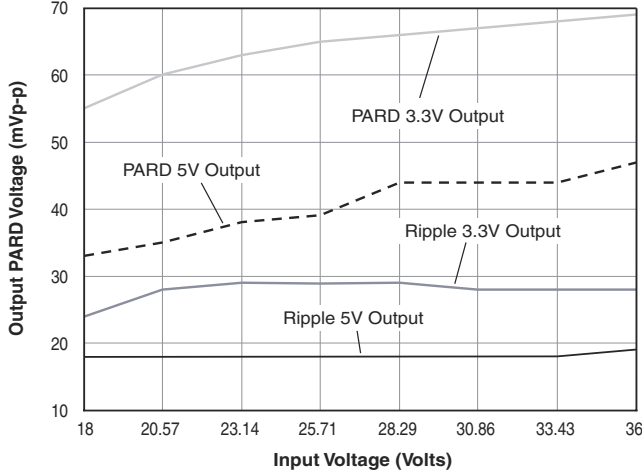

**D48 Model**

**Output Ripple and Noise (PARD) vs. Input Voltage**  
(One output @ 15A, other output @ 0A, PARD measured on loaded output, 20MHz bandwidth.)

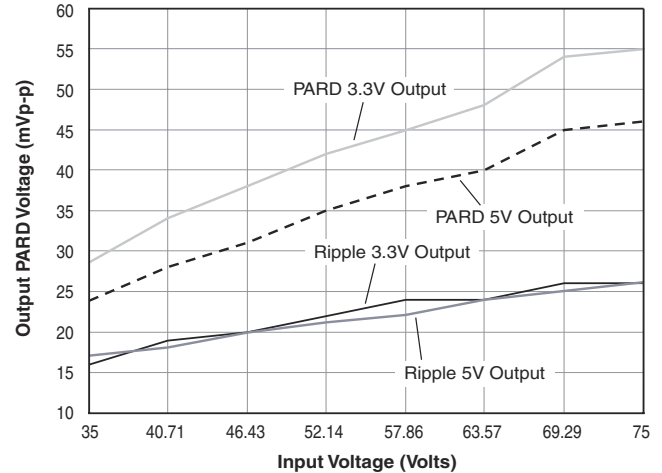

**Options and Adaptations**

**Optional Functions**

The BCP 75W DC/DC Dual Half-Bricks offer various electrical and mechanical options. Per the Ordering Guide on page 2, the trailing input voltage range (D24 or D48) in each part number pertains to the base part number. Part-number suffixes are added after the "input range," indicating the selection of standard options. The resulting part number is a "standard product" and is available to any customer desiring that particular combination of options, as described below.

Suffix	Description
Blank	On/Off Control function with positive polarity on pin 3 and independent trim function on either output (5V trim on pin 5 and 3.3V trim on pin 8). The pin length remains at 0.2 inches (5.08 mm).
N	On/Off Control function with negative polarity on pin 3.
L1	Trim the pin length to 0.110 ±0.010 inches (2.79 ±0.25mm). This option requires a 100-piece minimum order quantity.
L2	Trim the pin length to 0.145 ±0.010 inches (3.68 ±0.25mm). This option requires a 100-piece minimum order quantity.

**Adaptations**

There are various additional configurations available on BCP 75W DC/DC Dual Half-Bricks. Because designating each of them with a standard part-number suffix is not always feasible, DATEL assigns a 5-digit "adaptation code" after the part-number suffixes. Once a configuration has been requested by a customer and created by DATEL, the resulting product is available to any customer as a "standard" off-the-shelf product. Contact DATEL directly if you are interested in your own set of options/adaptations. Our policy for minimum order quantities may apply.

Consequently, the following product is offered for sale:

**BCP-5/15-3.3/15-D48-30752**

Standard product, 48VIN, 5V/15A and 3.3V/15A Outputs with positive On/Off logic and modified VOUT Trim functions (pin 5 and 8 positions) to be compatible with Power-One's HBD-series. Adapted low profile packaging of 0.5 inches (12.7 mm) and with trimmed pin length to 0.15 inches (3.8 mm).



DATEL, Inc. 11 Cabot Boulevard, Mansfield, MA 02048-1151  
Tel: (508) 339-3000 (800) 233-2765 Fax: (508) 339-6356  
**www.datel.com** Email: **sales@datel.com**  
**www.cdpowerelectronics.com**

ISO 9001 REGISTERED

DS-0449 1/05

**DATEL (UK) LTD.** Tadley, England Tel: (01256)-880444  
Internet: [www.datel-europe.com](http://www.datel-europe.com) E-mail: [datel.ltd@datel.com](mailto:datel.ltd@datel.com)

**DATEL S.A.R.L.** Montigny Le Bretonneux, France Tel: 01-34-60-01-01  
Internet: [www.datel-europe.com](http://www.datel-europe.com) E-mail: [datel.sarl@datel.com](mailto:datel.sarl@datel.com)

**DATEL GmbH** München, Germany Tel: 89-544334-0  
Internet: [www.datel-europe.com](http://www.datel-europe.com) E-mail: [datel.gmbh@datel.com](mailto:datel.gmbh@datel.com)

**DATEL KK** Tokyo, Japan Tel: 3-3779-1031, Osaka Tel: 6-6354-2025  
Internet: [www.datel.co.jp](http://www.datel.co.jp) Email: [salestko@datel.co.jp](mailto:salestko@datel.co.jp), [salesosa@datel.co.jp](mailto:salesosa@datel.co.jp)

**DATEL China** Shanghai, China Tel: 011-86-51317131  
E-mail: [davidx@datel.com](mailto:davidx@datel.com)

DATEL makes no representation that the use of its products in the circuits described herein, or the use of other technical information contained herein, will not infringe upon existing or future patent rights. The descriptions contained herein do not imply the granting of licenses to make, use, or sell equipment constructed in accordance therewith. Specifications are subject to change without notice. The DATEL logo is a registered DATEL, Inc. trademark.