

# BB202LX

## Low-voltage variable capacitance diode

Rev. 01 — 11 April 2006

Preliminary data sheet

## 1. Product profile

### 1.1 General description

The BB202LX is a planar technology variable capacitance diode in a SOD882T ultra small leadless plastic SMD package.

### 1.2 Features



- Very steep Capacitance-Voltage (CV) curve
- $C_{d(0V2)}$ : 30.5 pF;  $C_{d(2V3)}$ : 9.5 pF
- Ratio  $C_{d(0V2)}$  to  $C_{d(2V3)}$  minimal 2.5
- Ultra small leadless SMD package
- Low series resistance

### 1.3 Applications

- Voltage Controlled Oscillators (VCO)
- Electronic tuning in FM radios
- Recommended as the reference VCO varactor for Philips Tuner ICs TEA5764, TEA5767 and TEA5768 in mobile and portable platforms

## 2. Pinning information

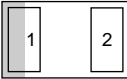
Table 1. Discrete pinning

Pin	Description	Simplified outline	Symbol
1	cathode	[1]	
2	anode	 Transparent top view	 <i>sym008</i>

[1] The marking bar indicates the cathode.

### 3. Ordering information

**Table 2. Ordering information**

Type number	Package		Version
	Name	Description	
BB202LX	-	leadless ultra small plastic package; 2 terminals; body 1.0 × 0.6 × 0.4 mm	SOD882T

### 4. Marking

**Table 3. Marking**

Type number	Marking code
BB202LX	L1

### 5. Limiting values

**Table 4. Limiting values**

*In accordance with the Absolute Maximum Rating System (IEC 60134).*

Symbol	Parameter	Conditions	Min	Max	Unit
$V_R$	reverse voltage		-	6	V
$I_F$	forward current		-	10	mA
$T_{stg}$	storage temperature		-55	+85	°C
$T_j$	junction temperature		-55	+85	°C

### 6. Characteristics

**Table 5. Characteristics**

$T_j = 25\text{ °C}$  unless otherwise specified.

Symbol	Parameter	Conditions	Min	Typ	Max	Unit
$I_R$	reverse current	see <a href="#">Figure 3</a>				
		$V_R = 6\text{ V}$	-	-	10	nA
		$V_R = 6\text{ V}; T_j = 85\text{ °C}$	-	-	100	nA
$r_s$	diode series resistance	$f = 100\text{ MHz}$ ; see <a href="#">Figure 2</a>	[1]	0.35	-	$\Omega$
$C_d$	diode capacitance	see <a href="#">Figure 1</a> and <a href="#">Figure 4</a> ; $f = 1\text{ MHz}$ ;				
		$V_R = 0.2\text{ V}$	28.2	-	33.5	pF
		$V_R = 2.3\text{ V}$	7.2	-	11.2	pF
$\frac{C_{d(0V2)}}{C_{d(2V3)}}$	diode capacitance ratio	$f = 1\text{ MHz}$	2.5	-	-	

[1]  $r_s$  is the value at which  $C_d = 30\text{ pF}$ .

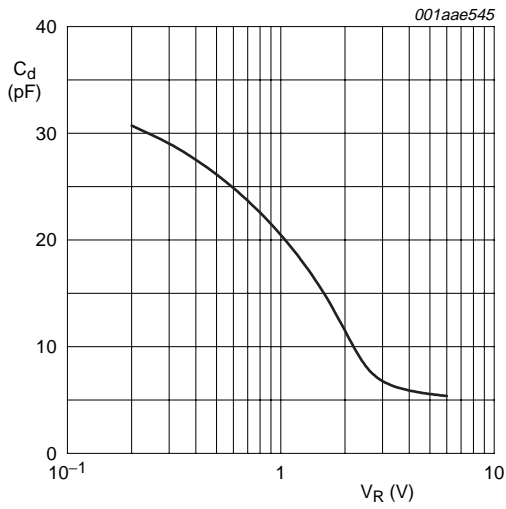

$f = 1 \text{ MHz}; T_j = 25 \text{ }^\circ\text{C}.$

**Fig. 1. Diode capacitance as a function of reverse voltage; typical values**

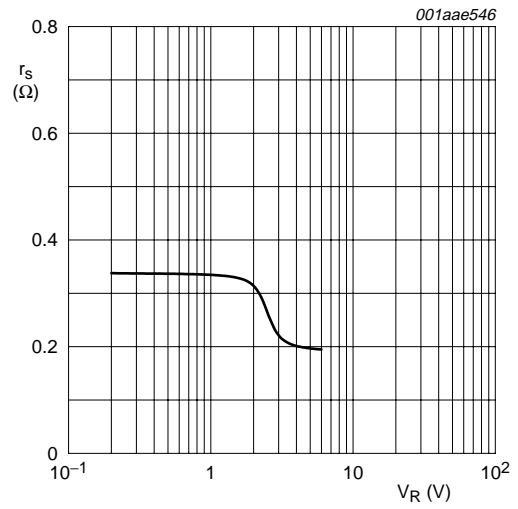

$f = 470 \text{ MHz}; T_j = 25 \text{ }^\circ\text{C}.$

**Fig. 2. Diode serial resistance as a function of reverse voltage; typical values**

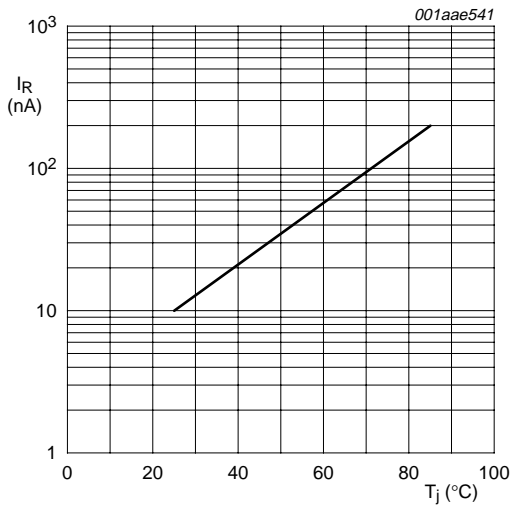

**Fig. 3. Reverse current as a function of junction temperature; maximum values**

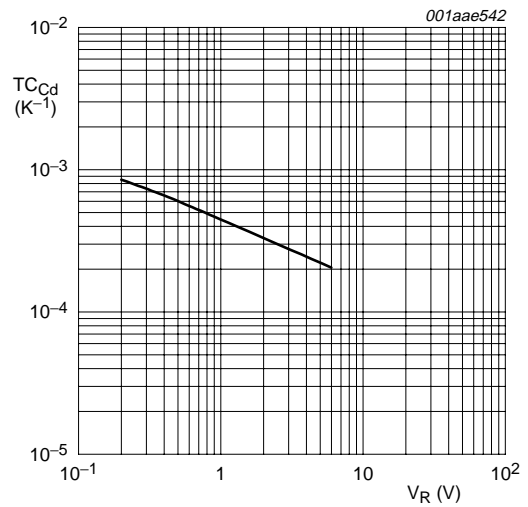

$T_j = 0 \text{ }^\circ\text{C} \text{ to } 85 \text{ }^\circ\text{C}.$

**Fig. 4. Temperature coefficient of diode capacitance as a function of reverse voltage; typical values**

7. Package outline

Leadless ultra small plastic package; 2 terminals; body 1.0 x 0.6 x 0.4 mm

SOD882T

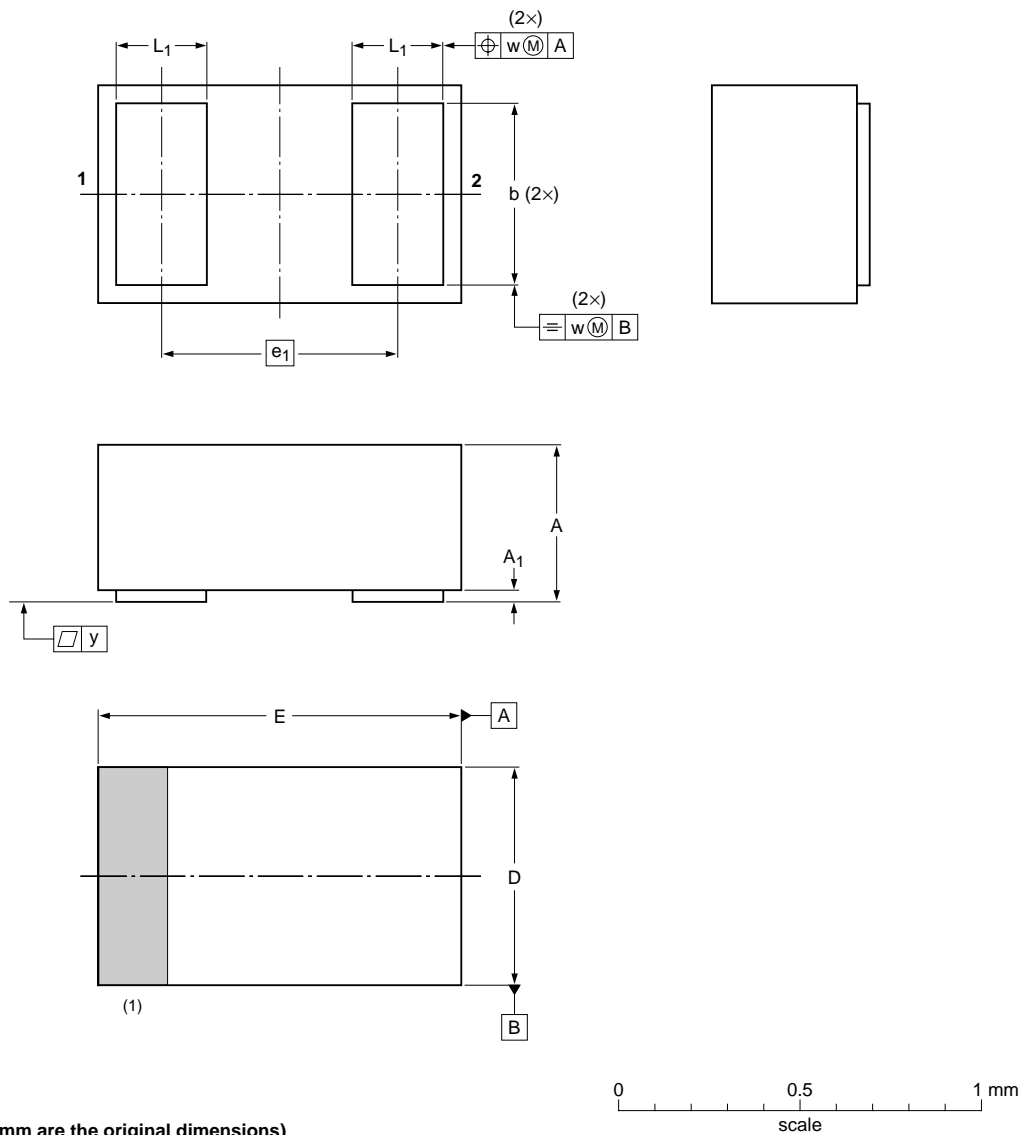

DIMENSIONS (mm are the original dimensions)

UNIT	A	A <sub>1 max</sub>	b	D	E	e <sub>1</sub>	L <sub>1</sub>	w	y
mm	0.40 0.36	0.04	0.55 0.45	0.65 0.55	1.05 0.95	0.65	0.30 0.22	0.1	0.03

Note

1. The marking bar indicates the cathode

OUTLINE VERSION	REFERENCES			EUROPEAN PROJECTION	ISSUE DATE
	IEC	JEDEC	JEITA		
SOD882T					04-12-14

Fig 5. Package outline SOD882T

## 8. Revision history

Table 6. Revision history

Document ID	Release date	Data sheet status	Change notice	Supersedes
BB202LX_1	20060411	Preliminary data sheet	-	-

## 9. Legal information

### 9.1 Data sheet status

Document status <sup>[1][2]</sup>	Product status <sup>[3]</sup>	Definition
Objective [short] data sheet	Development	This document contains data from the objective specification for product development.
Preliminary [short] data sheet	Qualification	This document contains data from the preliminary specification.
Product [short] data sheet	Production	This document contains the product specification.

[1] Please consult the most recently issued document before initiating or completing a design.

[2] The term 'short data sheet' is explained in section "Definitions".

[3] The product status of device(s) described in this document may have changed since this document was published and may differ in case of multiple devices. The latest product status information is available on the Internet at URL <http://www.semiconductors.philips.com>.

### 9.2 Definitions

**Draft** — The document is a draft version only. The content is still under internal review and subject to formal approval, which may result in modifications or additions. Philips Semiconductors does not give any representations or warranties as to the accuracy or completeness of information included herein and shall have no liability for the consequences of use of such information.

**Short data sheet** — A short data sheet is an extract from a full data sheet with the same product type number(s) and title. A short data sheet is intended for quick reference only and should not be relied upon to contain detailed and full information. For detailed and full information see the relevant full data sheet, which is available on request via the local Philips Semiconductors sales office. In case of any inconsistency or conflict with the short data sheet, the full data sheet shall prevail.

### 9.3 Disclaimers

**General** — Information in this document is believed to be accurate and reliable. However, Philips Semiconductors does not give any representations or warranties, expressed or implied, as to the accuracy or completeness of such information and shall have no liability for the consequences of use of such information.

**Right to make changes** — Philips Semiconductors reserves the right to make changes to information published in this document, including without limitation specifications and product descriptions, at any time and without notice. This document supersedes and replaces all information supplied prior to the publication hereof.

**Suitability for use** — Philips Semiconductors products are not designed, authorized or warranted to be suitable for use in medical, military, aircraft, space or life support equipment, nor in applications where failure or

malfunction of a Philips Semiconductors product can reasonably be expected to result in personal injury, death or severe property or environmental damage. Philips Semiconductors accepts no liability for inclusion and/or use of Philips Semiconductors products in such equipment or applications and therefore such inclusion and/or use is at the customer's own risk.

**Applications** — Applications that are described herein for any of these products are for illustrative purposes only. Philips Semiconductors makes no representation or warranty that such applications will be suitable for the specified use without further testing or modification.

**Limiting values** — Stress above one or more limiting values (as defined in the Absolute Maximum Ratings System of IEC 60134) may cause permanent damage to the device. Limiting values are stress ratings only and operation of the device at these or any other conditions above those given in the Characteristics sections of this document is not implied. Exposure to limiting values for extended periods may affect device reliability.

**Terms and conditions of sale** — Philips Semiconductors products are sold subject to the general terms and conditions of commercial sale, as published at <http://www.semiconductors.philips.com/profile/terms>, including those pertaining to warranty, intellectual property rights infringement and limitation of liability, unless explicitly otherwise agreed to in writing by Philips Semiconductors. In case of any inconsistency or conflict between information in this document and such terms and conditions, the latter will prevail.

**No offer to sell or license** — Nothing in this document may be interpreted or construed as an offer to sell products that is open for acceptance or the grant, conveyance or implication of any license under any copyrights, patents or other industrial or intellectual property rights.

### 9.4 Trademarks

Notice: All referenced brands, product names, service names and trademarks are the property of their respective owners.

## 10. Contact information

For additional information, please visit: <http://www.semiconductors.philips.com>

For sales office addresses, send an email to: [sales.addresses@www.semiconductors.philips.com](mailto:sales.addresses@www.semiconductors.philips.com)

## 11. Contents

<b>1</b>	<b>Product profile</b> .....	<b>1</b>
1.1	General description .....	1
1.2	Features .....	1
1.3	Applications .....	1
<b>2</b>	<b>Pinning information</b> .....	<b>1</b>
<b>3</b>	<b>Ordering information</b> .....	<b>2</b>
<b>4</b>	<b>Marking</b> .....	<b>2</b>
<b>5</b>	<b>Limiting values</b> .....	<b>2</b>
<b>6</b>	<b>Characteristics</b> .....	<b>2</b>
<b>7</b>	<b>Package outline</b> .....	<b>4</b>
<b>8</b>	<b>Revision history</b> .....	<b>5</b>
<b>9</b>	<b>Legal information</b> .....	<b>6</b>
9.1	Data sheet status .....	6
9.2	Definitions .....	6
9.3	Disclaimers .....	6
9.4	Trademarks .....	6
<b>10</b>	<b>Contact information</b> .....	<b>6</b>
<b>11</b>	<b>Contents</b> .....	<b>7</b>



Please be aware that important notices concerning this document and the product(s) described herein, have been included in section 'Legal information'.

© Koninklijke Philips Electronics N.V. 2006. All rights reserved.

For more information, please visit: <http://www.semiconductors.philips.com>.

For sales office addresses, email to: [sales.addresses@www.semiconductors.philips.com](mailto:sales.addresses@www.semiconductors.philips.com).

Date of release: 11 April 2006

Document identifier: BB202LX\_1