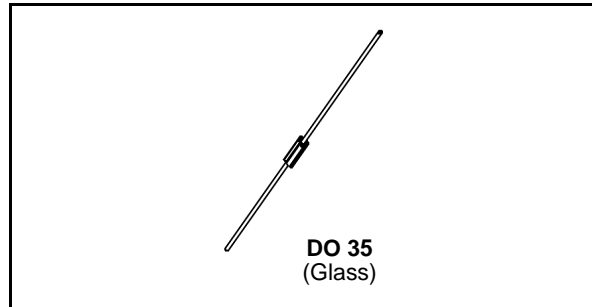

SMALL SIGNAL SCHOTTKY DIODE
DESCRIPTION

General purpose metal to silicon diode featuring very low turn-on voltage and fast switching.

This device has integrated protection against excessive voltage such as electrostatic discharges.

ABSOLUTE RATINGS (limiting values)

Symbol	Parameter	Value	Unit
V_{RRM}	Repetitive Peak Reverse Voltage	100	V
I_F	Forward Continuous Current*	$T_a = 25\text{ }^\circ\text{C}$ 100	mA
I_{FRM}	Repetitive Peak Forward Current*	$t_p \leq 1\text{ s}$ $\delta \leq 0.5$ 350	mA
I_{FSM}	Surge non Repetitive Forward Current*	$t_p \leq 10\text{ ms}$ 750	mA
P_{tot}	Power Dissipation*	$T_a = 95\text{ }^\circ\text{C}$ 100	mW
T_{stg} T_j	Storage and Junction Temperature Range	- 65 to +150 - 65 to +125	$^\circ\text{C}$ $^\circ\text{C}$
T_L	Maximum Lead Temperature for Soldering during 10s at 4mm from Case	230	$^\circ\text{C}$

THERMAL RESISTANCE

Symbol	Test Conditions	Value	Unit
$R_{th(j-a)}$	Junction-ambient*	300	$^\circ\text{C/W}$

ELECTRICAL CHARACTERISTICS
STATIC CHARACTERISTICS

Symbol	Test Conditions	Min.	Typ.	Max.	Unit
V_{BR}	$T_j = 25\text{ }^\circ\text{C}$ $I_R = 100\text{ }\mu\text{A}$	100			V
V_F^{**}	$T_j = 25\text{ }^\circ\text{C}$ $I_F = 1\text{ mA}$		0.4	0.45	V
	$T_j = 25\text{ }^\circ\text{C}$ $I_F = 200\text{ mA}$			1	
I_R^{**}	$T_j = 25\text{ }^\circ\text{C}$			0.1	μA
	$T_j = 100\text{ }^\circ\text{C}$			20	

DYNAMIC CHARACTERISTICS

Symbol	Test Conditions	Min.	Typ.	Max.	Unit
C	$T_j = 25\text{ }^\circ\text{C}$ $V_R = 1\text{ V}$ $f = 1\text{ MHz}$		2		pF

* On infinite heatsink with 4mm lead length

** Pulse test: $t_p \leq 300\text{ }\mu\text{s}$ $\delta < 2\%$.

Figure 1. Forward current versus forward voltage at different temperatures (typical values).

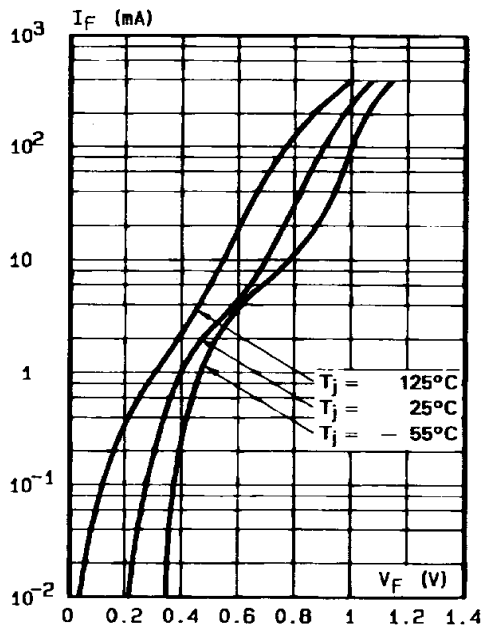

Figure 2. Forward current versus forward voltage (typical values).

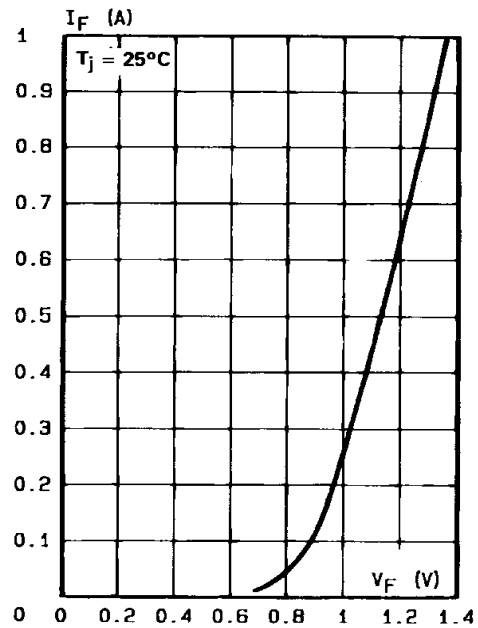

Figure 3. Reverse current versus junction temperature.

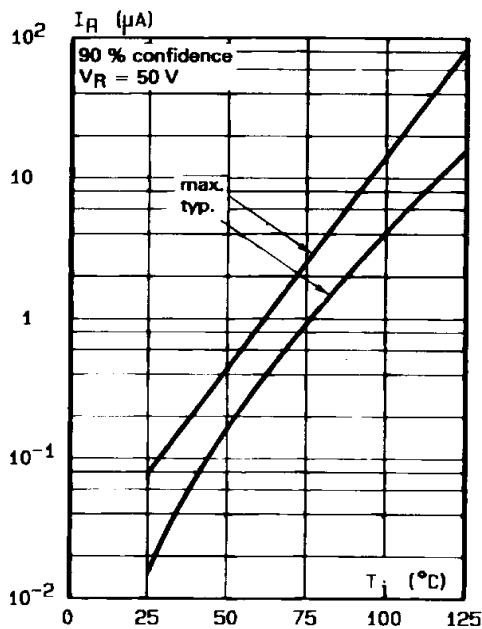

Figure 4. Reverse current versus continuous reverse voltage (typical values).

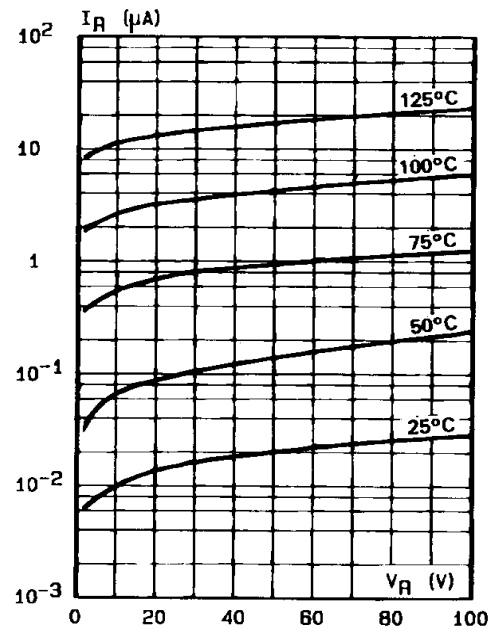
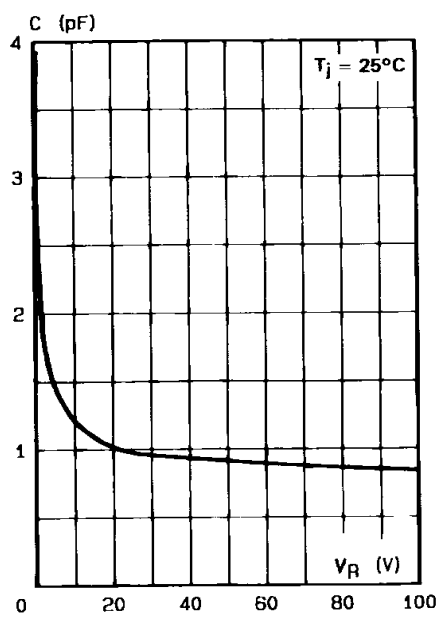

Figure 5. Capacitance C versus reverse applied voltage V_R (typical values).



BAT 41

PACKAGE MECHANICAL DATA

DO 35 Glass

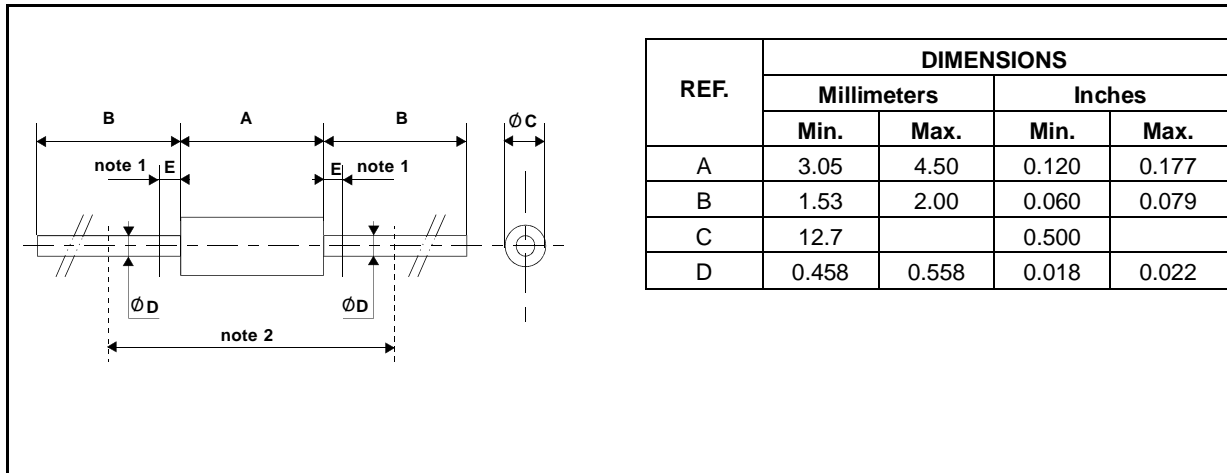

Cooling method : by convection and conduction
Marking: clear, ring at cathode end.
Weight: 0.15g

Information furnished is believed to be accurate and reliable. However, STMicroelectronics assumes no responsibility for the consequences of use of such information nor for any infringement of patents or other rights of third parties which may result from its use. No license is granted by implication or otherwise under any patent or patent rights of STMicroelectronics. Specifications mentioned in this publication are subject to change without notice. This publication supersedes and replaces all information previously supplied. STMicroelectronics products are not authorized for use as critical components in life support devices or systems without express written approval of STMicroelectronics.

The ST logo is a registered trademark of STMicroelectronics
© 1999 STMicroelectronics - Printed in Italy - All rights reserved.

STMicroelectronics GROUP OF COMPANIES
Australia - Brazil - China - Finland - France - Germany - Hong Kong - India - Italy - Japan - Malaysia
Malta - Morocco - Singapore - Spain - Sweden - Switzerland - United Kingdom - U.S.A.

<http://www.st.com>