

BAS21SLT1

Preferred Device

Dual Series High Voltage Switching Diode

Features

- Moisture Sensitivity Level: 1
- ESD Rating – Human Body Model: Class 1
– Machine Model: Class B
- Pb-Free Package is Available

MAXIMUM RATINGS

Rating	Symbol	Value	Unit
Continuous Reverse Voltage	V_R	250	Vdc
Repetitive Peak Reverse Voltage	V_{RRM}	250	Vdc
Peak Forward Current	I_F	225	mAdc
Peak Forward Surge Current	$I_{FM(surge)}$	625	mAdc

THERMAL CHARACTERISTICS

Characteristic	Symbol	Max	Unit
Total Device Dissipation FR-5 Board (Note 1) $T_A = 25^\circ\text{C}$ Derate above 25°C	P_D	225	mW
		1.8	mW/ $^\circ\text{C}$
Thermal Resistance, Junction to Ambient	$R_{\theta JA}$	556	$^\circ\text{C}/\text{W}$
Total Device Dissipation Alumina Substrate, (Note 2) $T_A = 25^\circ\text{C}$ Derate above 25°C	P_D	300	mW
		2.4	mW/ $^\circ\text{C}$
Thermal Resistance, Junction to Ambient	$R_{\theta JA}$	417	$^\circ\text{C}/\text{W}$
Junction and Storage Temperature Range	T_J, T_{stg}	-55 to +150	$^\circ\text{C}$

- FR-5 = $1.0 \times 0.75 \times 0.062$ in.
- Alumina = $0.4 \times 0.3 \times 0.024$ in. 99.5% alumina.

Maximum ratings are those values beyond which device damage can occur. Maximum ratings applied to the device are individual stress limit values (not normal operating conditions) and are not valid simultaneously. If these limits are exceeded, device functional operation is not implied, damage may occur and reliability may be affected.



ON Semiconductor®

<http://onsemi.com>

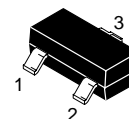
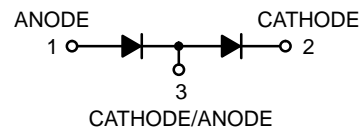

SOT-23
CASE 318
STYLE 11

MARKING DIAGRAM

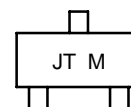

JT = Device Code
M = Date Code

ORDERING INFORMATION

Device	Package	Shipping†
BAS21SLT1	SOT-23	3000/Tape & Reel
BAS21SLT1G	SOT-23 (Pb-Free)	3000/Tape & Reel

†For information on tape and reel specifications, including part orientation and tape sizes, please refer to our Tape and Reel Packaging Specifications Brochure, BRD8011/D.

Preferred devices are recommended choices for future use and best overall value.

BAS21SLT1

ELECTRICAL CHARACTERISTICS ($T_A = 25^\circ\text{C}$ unless otherwise noted)

Characteristic	Symbol	Min	Max	Unit
OFF CHARACTERISTICS				
Reverse Voltage Leakage Current ($V_R = 200\text{ Vdc}$) ($V_R = 200\text{ Vdc}$, $T_J = 150^\circ\text{C}$)	I_R	-	0.1 100	μAdc
Reverse Breakdown Voltage ($I_{BR} = 100\ \mu\text{Adc}$)	$V_{(BR)}$	250	-	Vdc
Forward Voltage ($I_F = 100\ \text{mA}$) ($I_F = 200\ \text{mA}$)	V_F	-	1000 1250	mV
Diode Capacitance ($V_R = 0$, $f = 1.0\ \text{MHz}$)	C_D	-	5.0	pF
Reverse Recovery Time ($I_F = I_R = 30\ \text{mA}$, $R_L = 100\ \Omega$)	t_{rr}	-	50	ns

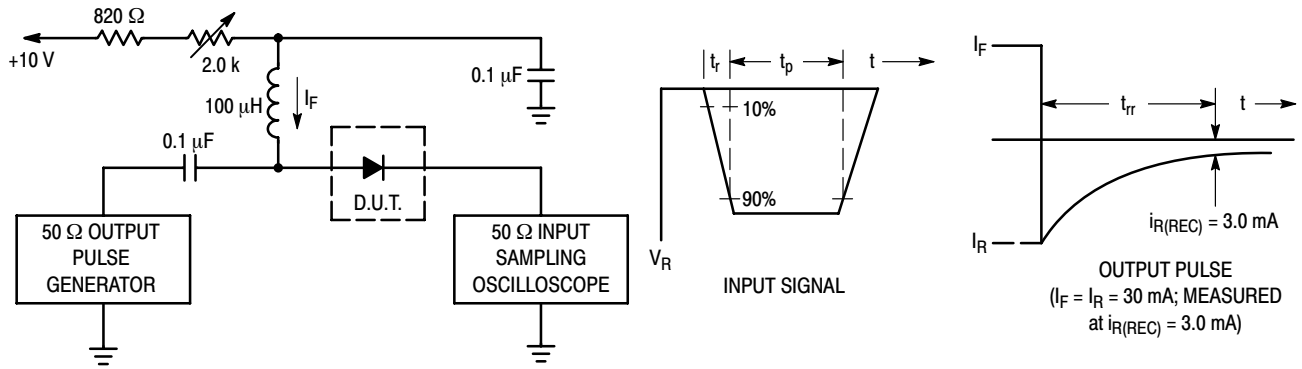

- Notes: 1. A 2.0 k Ω variable resistor adjusted for a Forward Current (I_F) of 30 mA.
 2. Input pulse is adjusted so $I_{R(\text{peak})}$ is equal to 30 mA.
 3. $t_p \gg t_{rr}$

Figure 1. Recovery Time Equivalent Test Circuit

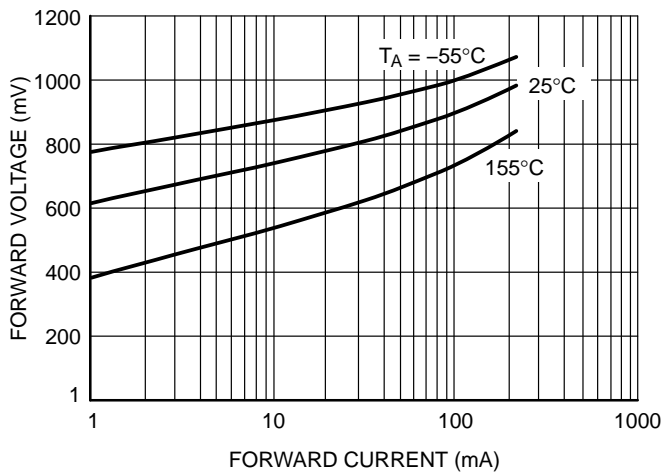

Figure 2. Forward Voltage

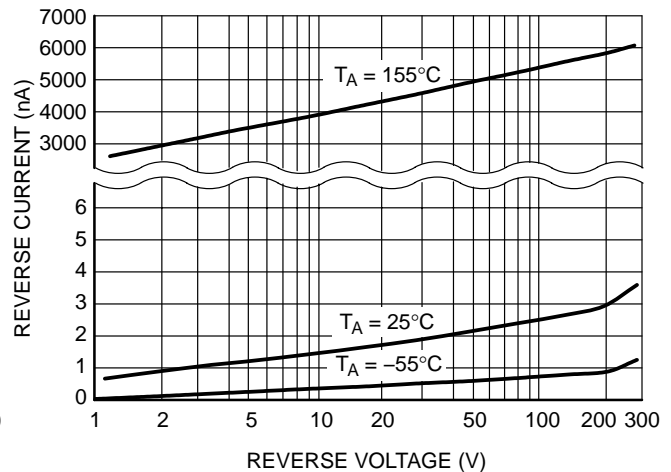
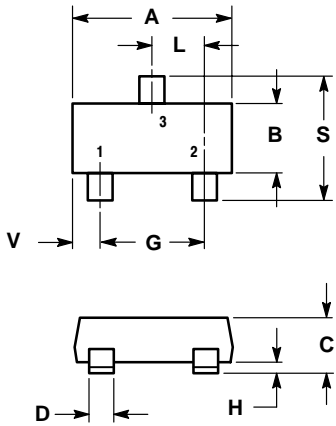

Figure 3. Reverse Leakage

BAS21SLT1

PACKAGE DIMENSIONS

SOT-23 (TO-236)
CASE 318-09
ISSUE AH



NOTES:

1. DIMENSIONING AND TOLERANCING PER ANSI Y14.5M, 1982.
2. CONTROLLING DIMENSION: INCH.
3. MAXIMUM LEAD THICKNESS INCLUDES LEAD FINISH THICKNESS. MINIMUM LEAD THICKNESS IS THE MINIMUM THICKNESS OF BASE MATERIAL.
4. 318-01, -02, AND -06 OBSOLETE, NEW STANDARD 318-09.

DIM	INCHES		MILLIMETERS	
	MIN	MAX	MIN	MAX
A	0.1102	0.1197	2.80	3.04
B	0.0472	0.0551	1.20	1.40
C	0.0385	0.0498	0.99	1.26
D	0.0140	0.0200	0.36	0.50
G	0.0670	0.0826	1.70	2.10
H	0.0040	0.0098	0.10	0.25
J	0.0034	0.0070	0.085	0.177
K	0.0180	0.0236	0.45	0.60
L	0.0350	0.0401	0.89	1.02
S	0.0830	0.0984	2.10	2.50
V	0.0177	0.0236	0.45	0.60

STYLE 11:

- PIN 1. ANODE
2. CATHODE
3. CATHODE-ANODE

SOLDERING FOOTPRINT*

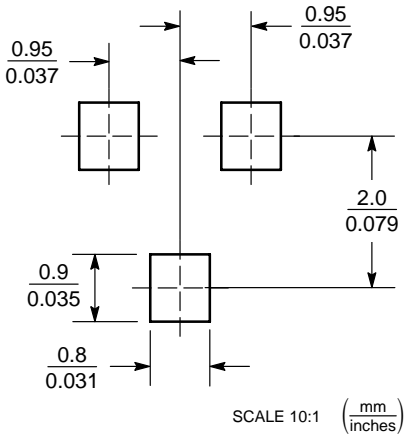

*For additional information on our Pb-Free strategy and soldering details, please download the ON Semiconductor Soldering and Mounting Techniques Reference Manual, SOLDERRM/D.

BAS21SLT1

ON Semiconductor and  are registered trademarks of Semiconductor Components Industries, LLC (SCILLC). SCILLC reserves the right to make changes without further notice to any products herein. SCILLC makes no warranty, representation or guarantee regarding the suitability of its products for any particular purpose, nor does SCILLC assume any liability arising out of the application or use of any product or circuit, and specifically disclaims any and all liability, including without limitation special, consequential or incidental damages. "Typical" parameters which may be provided in SCILLC data sheets and/or specifications can and do vary in different applications and actual performance may vary over time. All operating parameters, including "Typicals" must be validated for each customer application by customer's technical experts. SCILLC does not convey any license under its patent rights nor the rights of others. SCILLC products are not designed, intended, or authorized for use as components in systems intended for surgical implant into the body, or other applications intended to support or sustain life, or for any other application in which the failure of the SCILLC product could create a situation where personal injury or death may occur. Should Buyer purchase or use SCILLC products for any such unintended or unauthorized application, Buyer shall indemnify and hold SCILLC and its officers, employees, subsidiaries, affiliates, and distributors harmless against all claims, costs, damages, and expenses, and reasonable attorney fees arising out of, directly or indirectly, any claim of personal injury or death associated with such unintended or unauthorized use, even if such claim alleges that SCILLC was negligent regarding the design or manufacture of the part. SCILLC is an Equal Opportunity/Affirmative Action Employer. This literature is subject to all applicable copyright laws and is not for resale in any manner.

PUBLICATION ORDERING INFORMATION

LITERATURE FULFILLMENT:

Literature Distribution Center for ON Semiconductor
P.O. Box 5163, Denver, Colorado 80217 USA

Phone: 303-675-2175 or 800-344-3860 Toll Free USA/Canada

Fax: 303-675-2176 or 800-344-3867 Toll Free USA/Canada

Email: orderlit@onsemi.com

N. American Technical Support: 800-282-9855 Toll Free
USA/Canada

Japan: ON Semiconductor, Japan Customer Focus Center
2-9-1 Kamimeguro, Meguro-ku, Tokyo, Japan 153-0051
Phone: 81-3-5773-3850

ON Semiconductor Website: <http://onsemi.com>

Order Literature: <http://www.onsemi.com/litorder>

For additional information, please contact your
local Sales Representative.