



## IF Filters for Cordless Phones and ISM-Band Application

**Series/Type:**        **B8100**

The following products presented in this data sheet are being withdrawn.

Ordering Code	Substitute Product	Date of Withdrawal	Deadline Last Orders	Last Shipments
B39111B8100L100	B39111B4542Z910	2004-05-19	2004-09-30	2004-12-31

For further information please contact your nearest EPCOS sales office, which will also support you in selecting a suitable substitute. The addresses of our worldwide sales network are presented at [www.epcos.com/sales](http://www.epcos.com/sales).



## Withdrawn Products

The following products presented in this data sheet are being withdrawn:

B39111B8100L100

Date of withdrawal: 19-MAY-04

Deadline for last orders: 30-SEP-04

Last shipments: 31-DEC-04

For further information please contact your nearest EPCOS sales office, which will also support you in selecting a suitable substitute. The addresses of the sales offices are given on the Internet at [www.epcos.com/sales](http://www.epcos.com/sales).



# SAW Components

Data Sheet B 8100





**SAW Components**

**B 8100**

**Bandpass Filter**

**110,59 MHz**

**Data Sheet**

duroplast package **DIP18D**

**Features**

- IF filter for cordless application
- Channel selection in DECT system
- Low group delay ripple
- **Surface Mounted Technology (SMT)**
- Standard IC small outline (SO) package
- Balanced and unbalanced operation possible

**Terminals**

- Tinned CuFe alloy

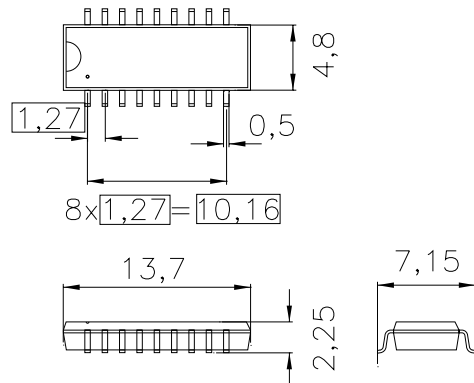

Dimensions in mm, approx. weight 0,4 g

**Pin configuration**

- 7 Input
- 8 Input ground or balanced input
- 16 Output
- 17 Output ground or balanced output
- 1,4,5,6,9,10 Chip carrier – ground
- 13,14,15,18 not connected
- 2,3,11,12 not connected

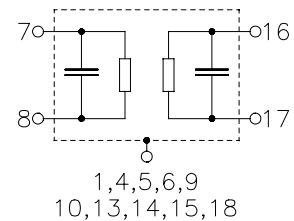

Type	Ordering code	Marking and Package according to	Packing according to
B8100	B39111-B8100-L100	C61157-A2-A4	F61074-V8058-Z000

Electrostatic Sensitive Device (ESD)

**Maximum ratings**

Operable temperature range	$T$	-25/+65	°C	
Storage temperature range	$T_{stg}$	-40/+85	°C	
DC voltage	$V_{DC}$	5	V	
Source power	$P_s$	10	dBm	



**SAW Components**

**B 8100**

**Bandpass Filter**

**110,59 MHz**

**Data Sheet**

**Characteristics**

Operating temperature range:  $T = +25\text{ }^\circ\text{C}$   
 Terminating source impedance:  $Z_S = 50\ \Omega (600\ \Omega \parallel 240\ \text{nH}^*)$   
 Terminating load impedance:  $Z_L = 50\ \Omega (140\ \Omega \parallel 110\ \text{nH}^*)$

		min.	typ.	max.	
<b>Nominal frequency</b>	$f_N$	—	110,59	—	MHz
<b>Center frequency</b> (center frequency between 10 dB points)	$f_c$	110,48	110,59	110,70	MHz
<b>Insertion attenuation at <math>f_N</math></b> (including losses in matching network)	$\alpha_N$	—	20,9 (13,5*)	22,4 (15,0*)	dB
<b>Passband width</b>	$B_{3\text{dB}}$	—	1,28	—	MHz
	$B_{30\text{dB}}$	—	2,40	—	MHz
<b>Group delay ripple (p-p)</b> $f_N - 600\ \text{kHz} \quad \dots \quad f_N + 600\ \text{kHz}$	$\Delta\tau$	—	180 (300*)	250 (400*)	ns
<b>Relative attenuation (relative to <math>\alpha_N</math>)</b>	$\alpha_{\text{rel}}$				
$f_N - 576\ \text{kHz} \quad \dots \quad f_N + 576\ \text{kHz}$		—	2,0	4,0	dB
$f_N \pm 576\ \text{kHz} \quad \dots \quad f_N \pm 700\ \text{kHz}$		—	—	10,0	dB
$f_N \pm 1,6\ \text{MHz} \quad \dots \quad f_N \pm 3,1\ \text{MHz}$		32	38	—	dB
$f_N \pm 3,1\ \text{MHz} \quad \dots \quad f_N \pm 4,6\ \text{MHz}$		40	44	—	dB
$f_N \pm 4,6\ \text{MHz} \quad \dots \quad f_N \pm 20\ \text{MHz}$		45	50	—	dB
$f_N \pm 1,728\ \text{MHz}$		32	38	—	dB
$f_N \pm 2 \times 1,728\ \text{MHz}$		42	47	—	dB
$f_N \pm 3 \times 1,728\ \text{MHz}$		48	53	—	dB
<b>Impedance at <math>f_N</math></b>					
Input: $Z_{\text{IN}} = R_{\text{IN}} \parallel C_{\text{IN}}$		—	600 $\parallel$ 8,5	—	$\Omega \parallel \text{pF}$
Output: $Z_{\text{OUT}} = R_{\text{OUT}} \parallel C_{\text{OUT}}$		—	140 $\parallel$ 19,0	—	$\Omega \parallel \text{pF}$
<b>Temperature coefficient of frequency</b>	$TC_f$	—	-18	—	ppm/K

\*) with matching network to 50  $\Omega$  (element values depend on PCB layout):

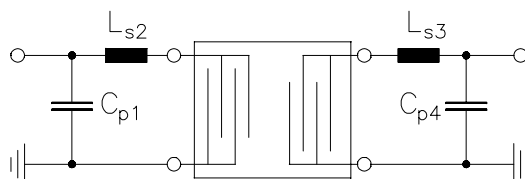

$C_{p1} = 0\ \text{pF}$   
 $L_{s2} = 220\ \text{nH}$   
 $L_{s3} = 120\ \text{nH}$   
 $C_{p4} = 22\ \text{pF}$



Data Sheet

Transfer function:

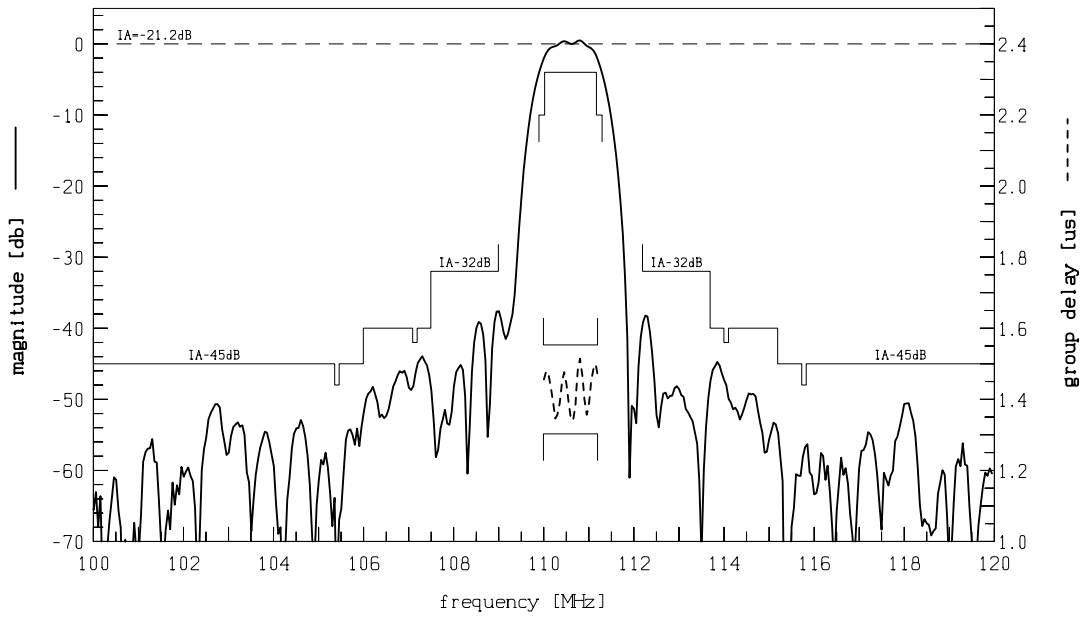

Transfer function (pass band):

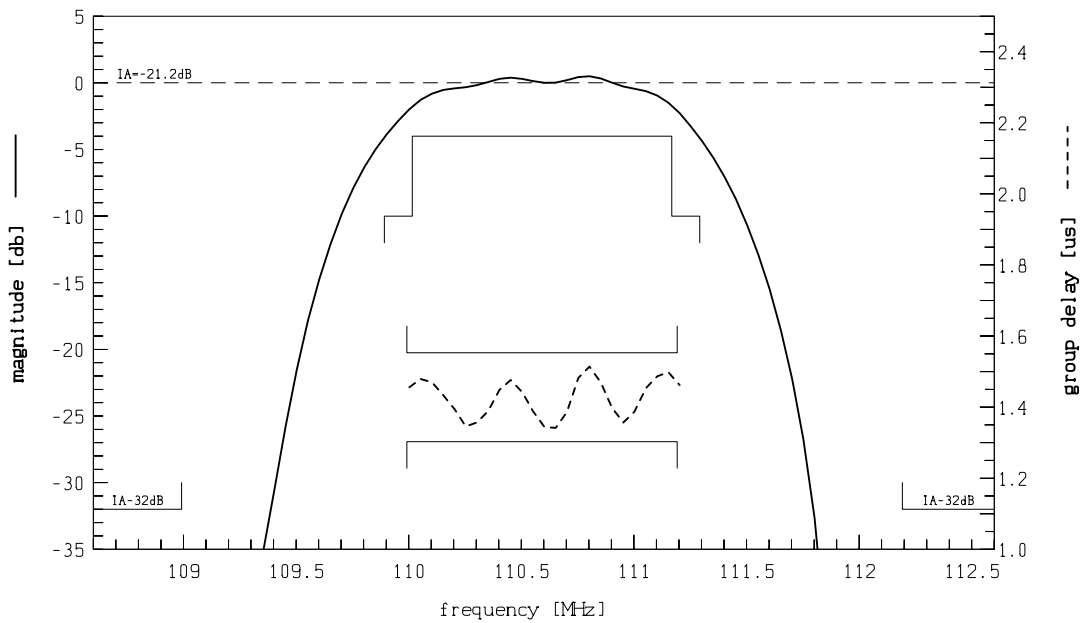



Data Sheet

Recommended Pin Configurations:

For optimum performance use the following pin configurations.

Balanced-balanced operation:

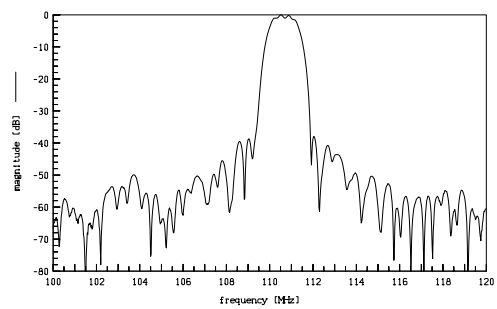
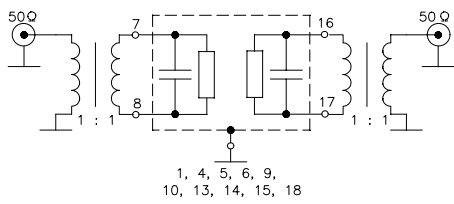

Balanced-unbalanced operation:

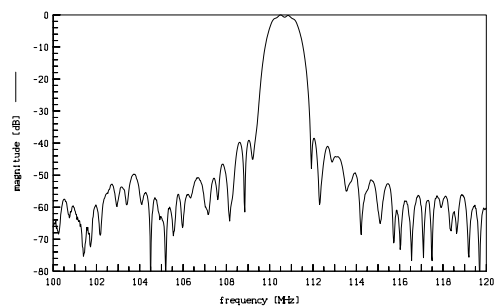
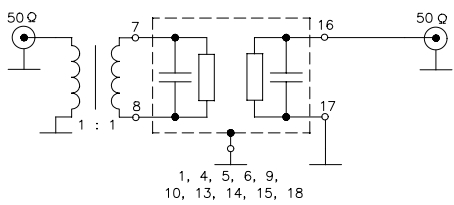

Unbalanced-unbalanced operation

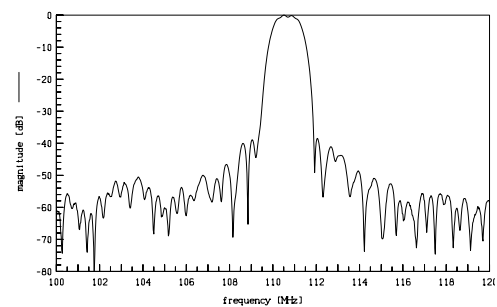
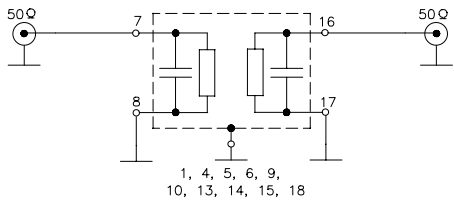



Data Sheet

Matching Stability / Variation of the Matching Network:

All matching-elements changed by  $\pm 10\%$  (simulation).

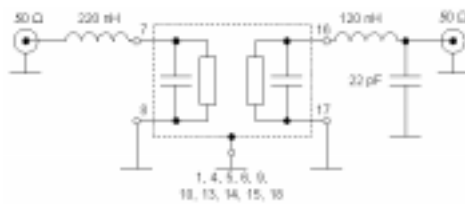

Transfer function of matched filter ( $S_{21}$ ):

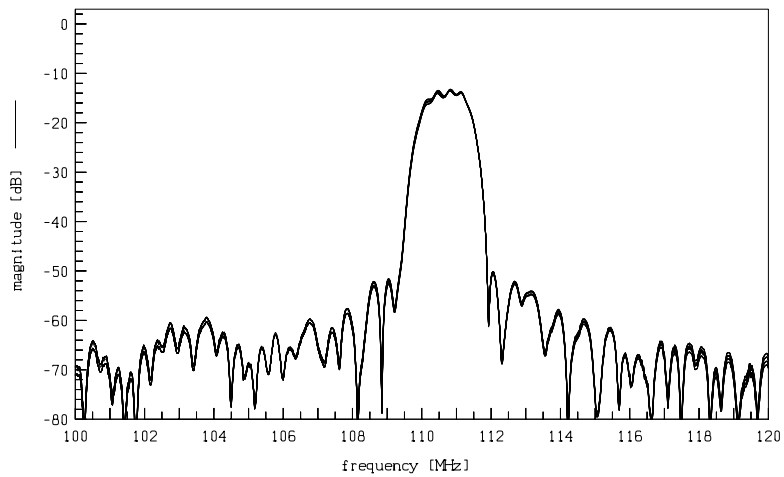

Impedance variation of matched filter (in passband):

$S_{11}$ :

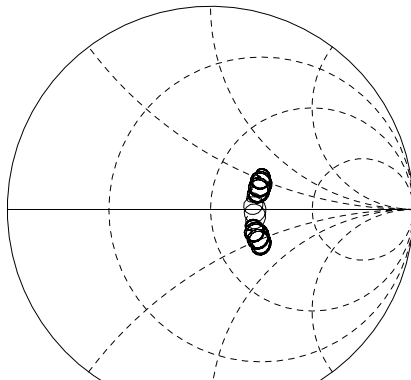

$S_{22}$ :

