

Features

- Guard Ring Die Construction for Transient Protection
- Ideally Suited for Automatic Assembly
- Low Power Loss, High Efficiency
- Surge Overload Rating to 125A Peak
- For Use in Low Voltage, High Frequency Inverters, Free Wheeling, and Polarity Protection Application
- **Lead Free Finish/RoHS Compliant (Note 4)**

Mechanical Data

- Case: SMC
- Case Material: Molded Plastic. UL Flammability Classification Rating 94V-0
- Moisture Sensitivity: Level 1 per J-STD-020C
- Terminals: Lead Free Plating (Matte Tin Finish). Solderable per MIL-STD-202, Method 208 
- Polarity: Cathode Band
- Marking Information: See Page 3
- Ordering Information: See Page 3
- Weight: 0.21 grams (approximate)

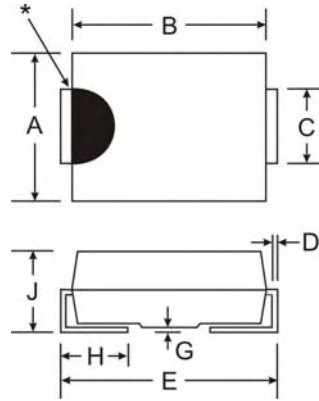

SMC		
Dim	Min	Max
A	5.59	6.22
B	6.60	7.11
C	2.75	3.18
D	0.15	0.31
E	7.75	8.13
G	0.10	0.20
H	0.76	1.52
J	2.00	2.62
All Dimensions in mm		

* Note: Device may have a semicircular indentation/notch on one side of the device (as shown).

Maximum Ratings and Electrical Characteristics @T_A = 25°C unless otherwise specified

Single phase, half wave, 60Hz, resistive or inductive load.
For capacitive load, derate current by 20%.

Characteristic	Symbol	B320	B330	B340	B350	B360	Unit	
Peak Repetitive Reverse Voltage	V _{RRM}							
Working Peak Reverse Voltage	V _{RWM}	20	30	40	50	60	V	
DC Blocking Voltage	V _R							
RMS Reverse Voltage	V _{R(RMS)}	14	21	28	35	42	V	
Average Rectified Output Current @ T _T = 100°C	I _O	3.0						A
Non-Repetitive Peak Forward Surge Current 8.3ms single half sine-wave superimposed on rated load	I _{FSM}	125						A
Forward Voltage (Note 3) @ I _F = 3.0A	V _{FM}	0.50			0.70		V	
Peak Reverse Current @ T _A = 25°C at Rated DC Blocking Voltage (Note 3) @ T _A = 100°C	I _{RM}	0.5 20						mA
Typical Capacitance (Note 2)	C _T	200						pF
Typical Thermal Resistance, Junction to Terminal	R _{θJT}	20						°C/W
Typical Thermal Resistance, Junction to Ambient (Note 1)	R _{θJA}	90						°C/W
Operating Temperature Range	T _J	-55 to +125						°C
Storage Temperature Range	T _{STG}	-55 to +150						°C

- Notes:
1. Thermal Resistance: Junction to terminal, unit mounted on glass epoxy substrate with 2x3mm copper pad
 2. Measured at 1.0MHz and applied reverse voltage of 4.0V DC.
 3. Short duration test pulse used to minimize self-heating effect.
 4. RoHS revision 13.2.2003. Glass and high temperature solder exemptions applied, see *EU Directive Annex Notes 5 and 7*.

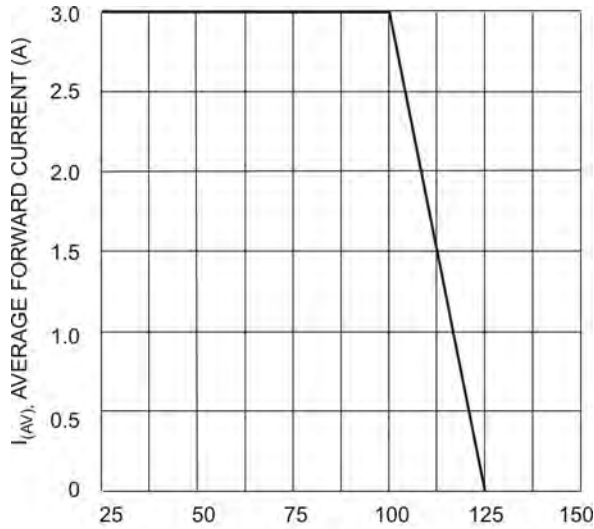

T_T , TERMINAL TEMPERATURE (°C)
Fig. 1 Forward Current Derating Curve

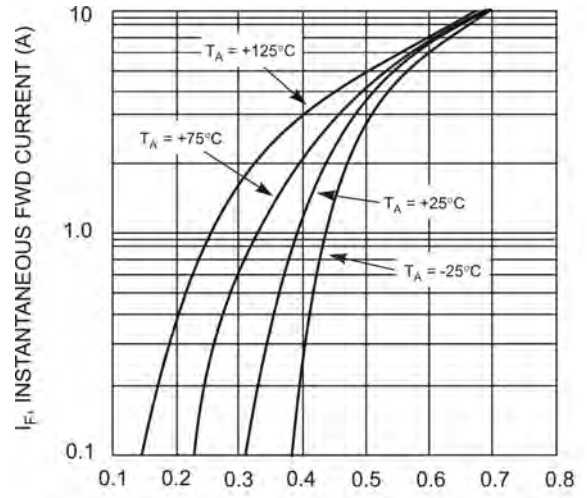

V_F , INSTANTANEOUS FORWARD VOLTAGE (V)
Fig. 2 Typical Forward Characteristics - B320B thru B340B

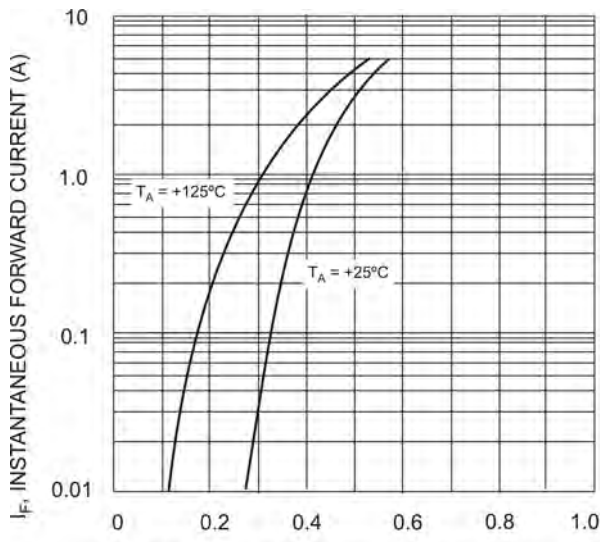

V_F , INSTANTANEOUS FORWARD VOLTAGE (V)
Fig. 3 Typ. Forward Characteristics - B350B thru B360B

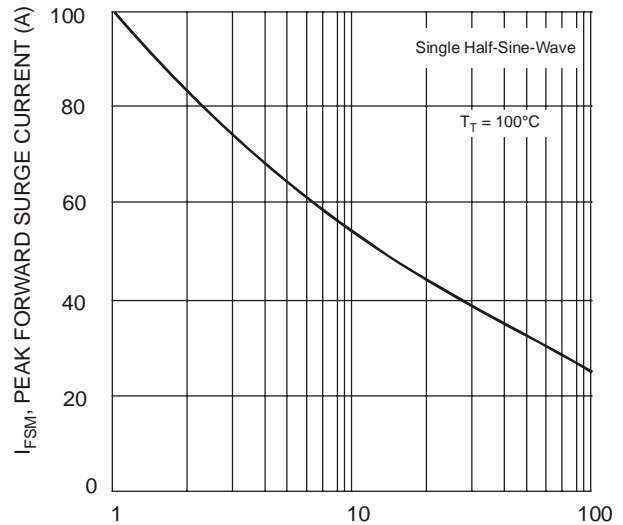

Single Half-Sine-Wave
 $T_T = 100^\circ\text{C}$
Fig. 4 Max Non-Repetitive Peak Forward Surge Current

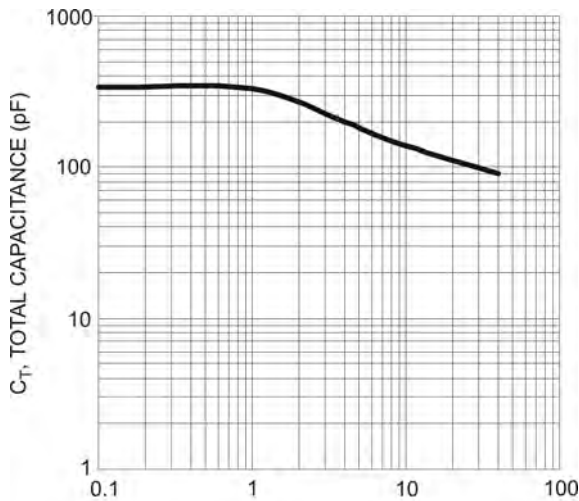

V_R , REVERSE VOLTAGE (V)
Fig. 5 Typical Capacitance

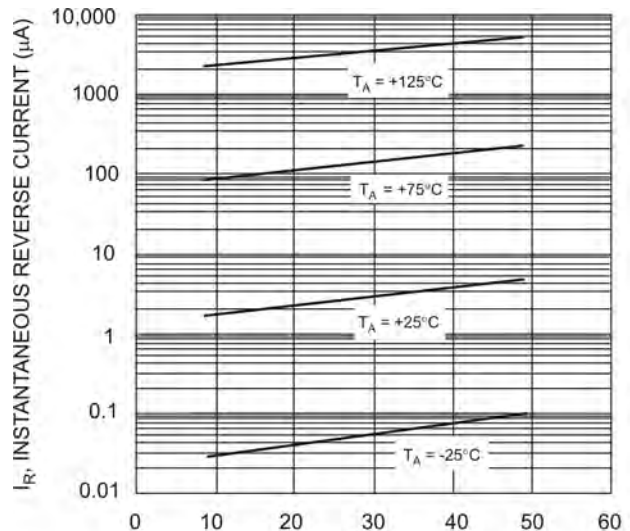

V_R , INSTANTANEOUS REVERSE VOLTAGE (V)
Fig. 6 Typical Reverse Characteristics, B320B thru B340B

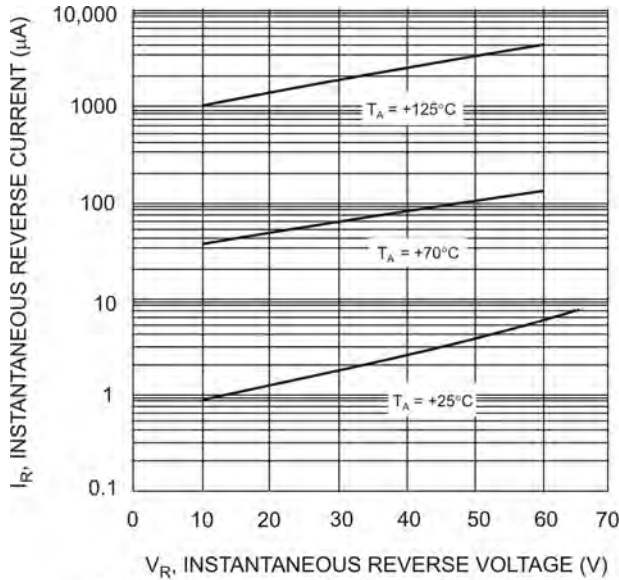

Fig. 7 Typical Reverse Characteristics, B350B thru B360B

Ordering Information (Note 5)

Device*	Packaging	Shipping
B3x0-13-F	SMC	3000/Tape & Reel

* x = Device type, e.g. B320-13-F (SMC package).

Notes: 5. For Packaging Details, go to our website at <http://www.diodes.com/datasheets/ap02007.pdf>.

Marking Information (Note 6)

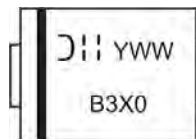

☺☺☺ = Manufacturers' code marking
 YWW = Date code marking
 Y = Last digit of year ex: 2 for 2002
 WW = Week code 01 to 52

Notes: 6. Device has a cathode band (as shown above) and may also have a cathode notch (as shown on Page 1).

IMPORTANT NOTICE

Diodes Incorporated and its subsidiaries reserve the right to make modifications, enhancements, improvements, corrections or other changes without further notice to any product herein. Diodes Incorporated does not assume any liability arising out of the application or use of any product described herein; neither does it convey any license under its patent rights, nor the rights of others. The user of products in such applications shall assume all risks of such use and will agree to hold Diodes Incorporated and all the companies whose products are represented on our website, harmless against all damages.

LIFE SUPPORT

Diodes Incorporated products are not authorized for use as critical components in life support devices or systems without the expressed written approval of the President of Diodes Incorporated.