



POSEICO SPA
POwer SEmiconductors Italian COrporation

POSEICO SPA
Via N. Lorenzi 8, 16152 Genova - ITALY
Tel. ++ 39 010 6556234 - Fax ++ 39 010 6557519
Sales Office:
Tel. ++ 39 010 6556775 - Fax ++ 39 010 6442510

FAST RECOVERY DIODE

ARF370

Repetitive voltage up to **4500 V**
Mean forward current **485 A**
Surge current **4 kA**

FINAL SPECIFICATION

feb 97 - ISSUE : 04

Symbol	Characteristic	Conditions	T _j [°C]	Value	Unit
BLOCKING					
V _{RRM}	Repetitive peak reverse voltage		150	4500	V
V _{RSM}	Non-repetitive peak reverse voltage		150	4600	V
I _{RRM}	Repetitive peak reverse current	V=V _{RRM}	150	50	mA
CONDUCTING					
I _{F(AV)}	Mean forward current	180° sin ,50 Hz, Th=55°C, double side cooled		485	A
I _{F(AV)}	Mean forward current	180° square,50 Hz,Th=55°C,double side cooled		490	A
I _{FSM}	Surge forward current	Sine wave, 10 ms reapplied reverse voltage up to 50% V _{RSM}	150	4	kA
I ² t	I ² t			80 x1E3	A ² s
V _{FM}	Forward voltage	Forward current = 1200 A	25	3.4	V
V _{F(TO)}	Threshold voltage		150	1.74	V
r _F	Forward slope resistance		150	1.700	mohm
SWITCHING					
t _{rr}	Reverse recovery time	I _F = 1000 A di/dt= 100 A/μs V _R = 100 V	150	5	μs
Q _{rr}	Reverse recovery charge			700	μC
I _{rr}	Peak reverse recovery current			280	A
s	Softness (s-factor), min			0.5	
V _{FR}	Peak forward recovery	di/dt= 400 A/μs	150	80	V
MOUNTING					
R _{th(j-h)}	Thermal impedance	Junction to heatsink, double side cooled		52	°C/kW
T _j	Operating junction temperature			-30 / 150	°C
F	Mounting force			8.4 / 9.4	kN
	Mass			280	g

ORDERING INFORMATION : ARF370 S 45

standard specification  VRRM/100

DISSIPATION CHARACTERISTICS

SQUARE WAVE

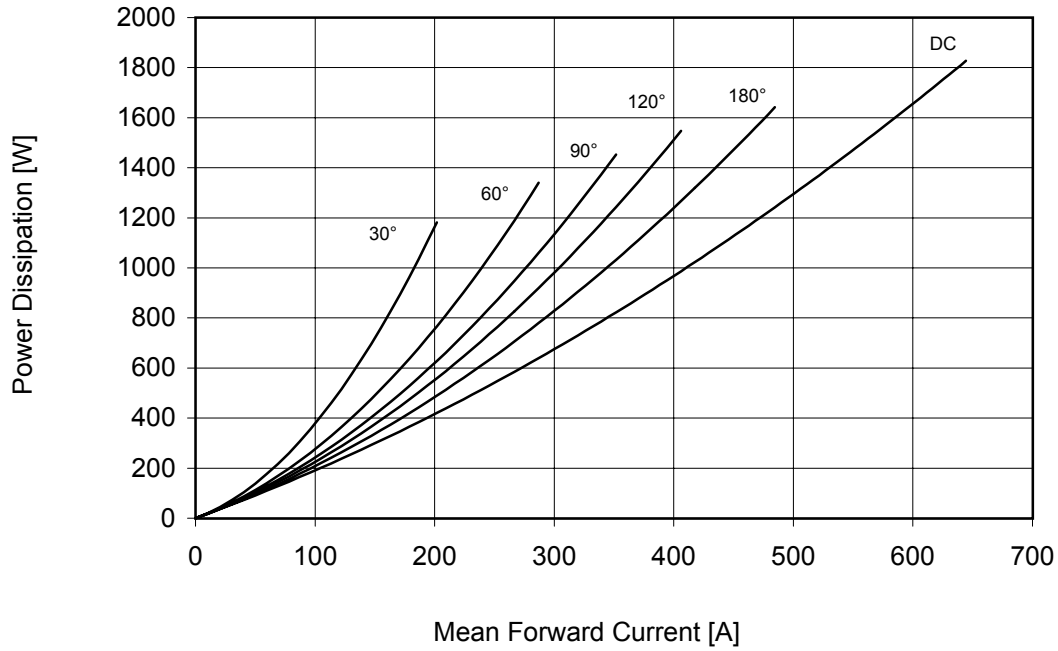

SINE WAVE

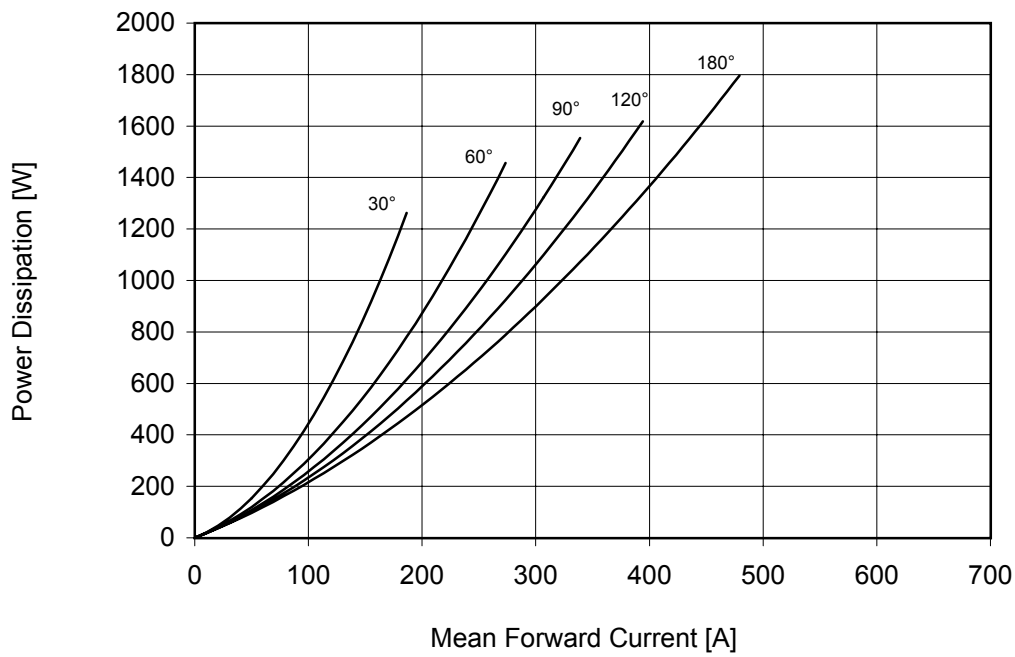

ARF370 FAST RECOVERY DIODE

FINAL SPECIFICATION feb 97 - ISSUE : 04

SWITCHING CHARACTERISTICS

FORWARD RECOVERY VOLTAGE

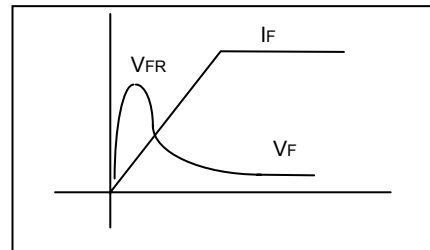
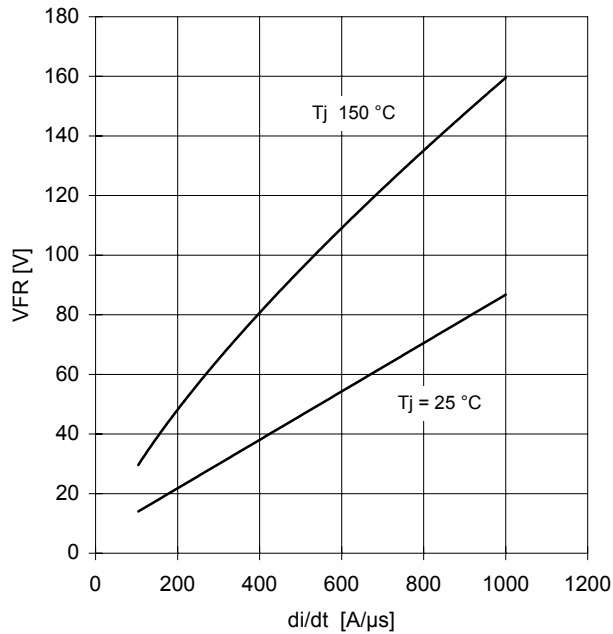

REVERSE RECOVERY CHARGE - Tj = 150°

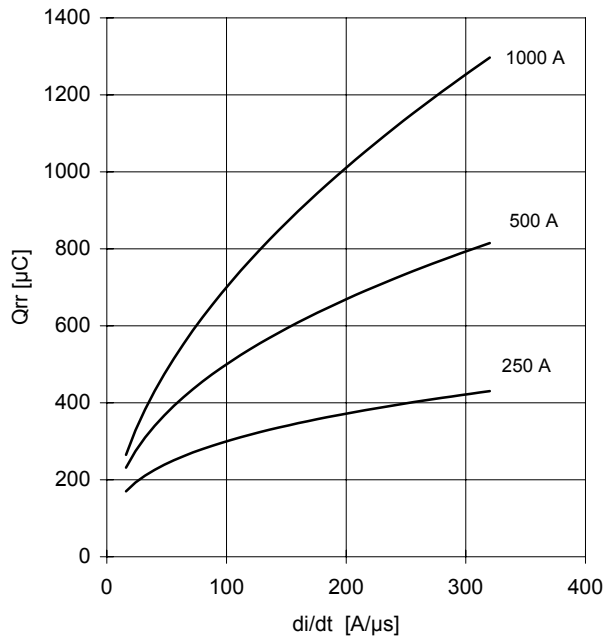

REVERSE RECOVERY CURRENT - Tj = 150°

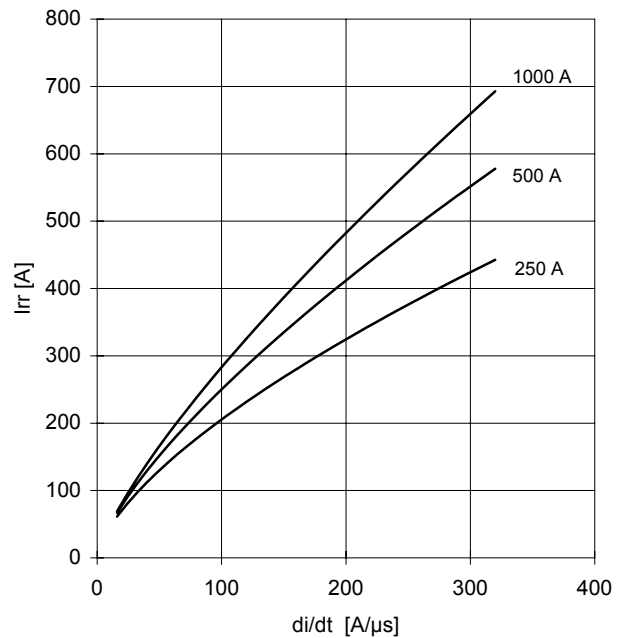

$$t_a = I_{rr} / (di/dt) \quad t_b = t_{rr} - t_a$$

$$\text{Softness (s factor)} \quad s = t_b / t_a$$

$$\text{Energy dissipation during recovery } E_r = V_r \cdot (Q_{rr} - I_{rr} \cdot t_a / 2)$$

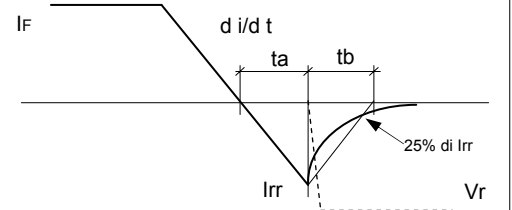

ARF370 FAST RECOVERY DIODE

FINAL SPECIFICATION feb 97 - ISSUE : 04

FORWARD CHARACTERISTIC
 $T_j = 150\text{ }^\circ\text{C}$

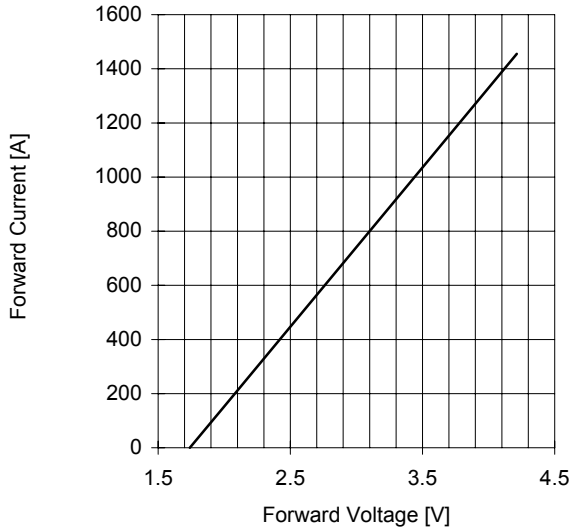

SURGE CHARACTERISTIC
 $T_j = 150\text{ }^\circ\text{C}$

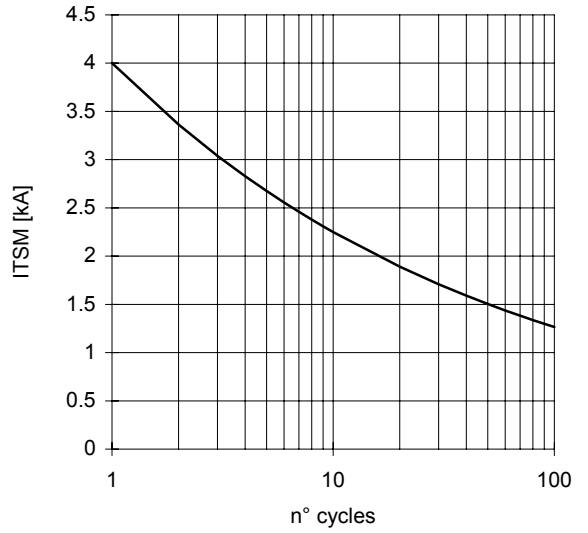

TRANSIENT THERMAL IMPEDANCE
DOUBLE SIDE COOLED

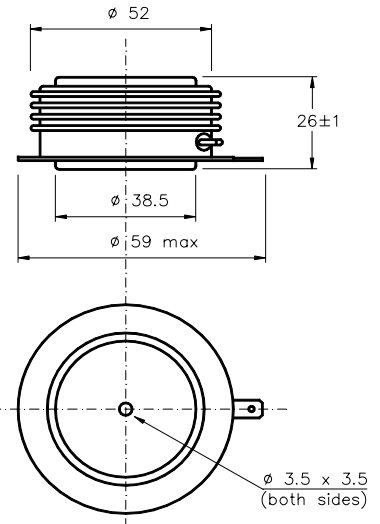
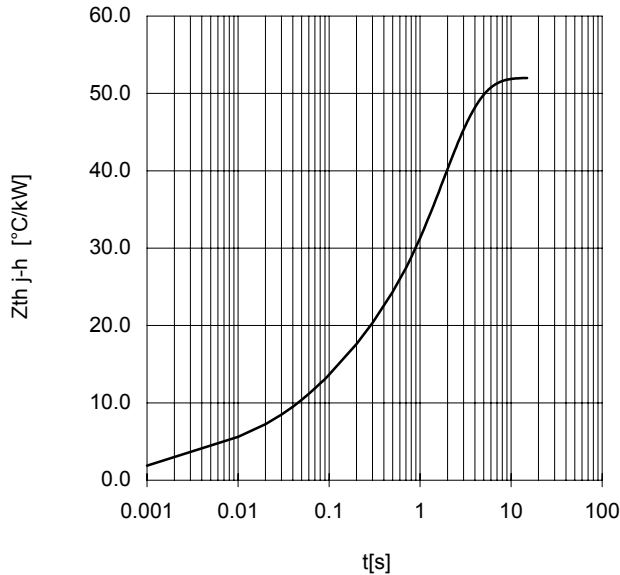

Dimensions in mm

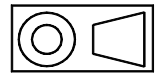

All the characteristics given in this data sheet are guaranteed only with uniform clamping force, cleaned and lubricated heatsink, surfaces with flatness $< .03 \text{ mm}$ and roughness $< 2 \mu\text{m}$.
In the interest of product improvement POSEICO SPA reserves the right to change any data given in this data sheet at any time without previous notice.
If not stated otherwise the maximum value of ratings (symbols over shaded background) and characteristics is reported.

Distributed by

