

*Single switch
with Series diodes
MOSFET Power Module*

**$V_{DSS} = 1200V$
 $R_{DSon} = 100m\Omega$ max @ $T_j = 25^\circ C$
 $I_D = 116A$ @ $T_c = 25^\circ C$**

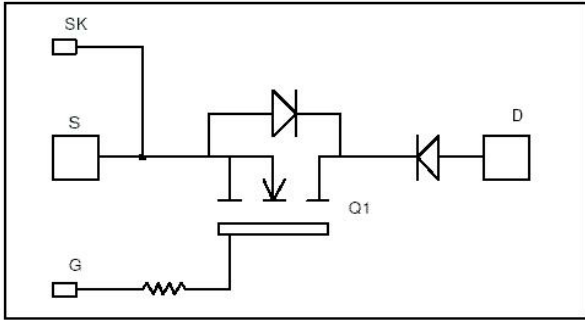

Application

- Zero Current Switching resonant mode

Features

- Power MOS 7[®] MOSFETs
 - Low R_{DSon}
 - Low input and Miller capacitance
 - Low gate charge
 - Avalanche energy rated
 - Very rugged
- Kelvin source for easy drive
- Very low stray inductance
 - Symmetrical design
 - M5 power connectors
- High level of integration
- AlN substrate for improved thermal performance

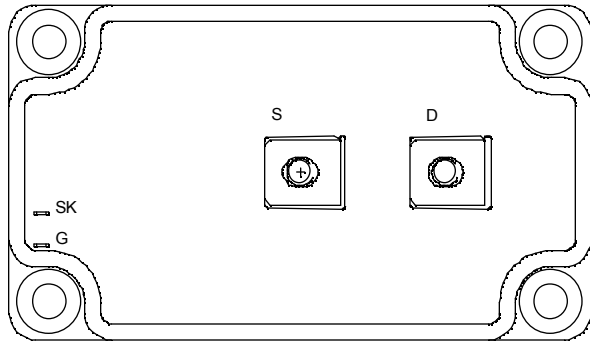

Benefits

- Outstanding performance at high frequency operation
- Direct mounting to heatsink (isolated package)
- Low junction to case thermal resistance
- Low profile

Absolute maximum ratings

Symbol	Parameter	Max ratings	Unit
V_{DSS}	Drain - Source Breakdown Voltage	1200	V
I_D	Continuous Drain Current	$T_c = 25^\circ C$	116
		$T_c = 80^\circ C$	86
I_{DM}	Pulsed Drain current	464	
V_{GS}	Gate - Source Voltage	± 30	V
R_{DSon}	Drain - Source ON Resistance	100	$m\Omega$
P_D	Maximum Power Dissipation	$T_c = 25^\circ C$	3290
I_{AR}	Avalanche current (repetitive and non repetitive)	24	A
E_{AR}	Repetitive Avalanche Energy	50	mJ
E_{AS}	Single Pulse Avalanche Energy	3200	

CAUTION: These Devices are sensitive to Electrostatic Discharge. Proper Handling Procedures Should Be Followed.

All ratings @ $T_j = 25^\circ\text{C}$ unless otherwise specified

Electrical Characteristics

Symbol	Characteristic	Test Conditions	Min	Typ	Max	Unit
BV_{DSS}	Drain - Source Breakdown Voltage	$V_{GS} = 0V, I_D = 1mA$	1200			V
I_{DSS}	Zero Gate Voltage Drain Current	$V_{GS} = 0V, V_{DS} = 1200V$ $T_j = 25^\circ\text{C}$			1	mA
		$V_{GS} = 0V, V_{DS} = 1000V$ $T_j = 125^\circ\text{C}$			4	
$R_{DS(on)}$	Drain - Source on Resistance	$V_{GS} = 10V, I_D = 58A$			100	m Ω
$V_{GS(th)}$	Gate Threshold Voltage	$V_{GS} = V_{DS}, I_D = 20mA$	3		5	V
I_{GSS}	Gate - Source Leakage Current	$V_{GS} = \pm 30V, V_{DS} = 0V$			± 400	nA

Dynamic Characteristics

Symbol	Characteristic	Test Conditions	Min	Typ	Max	Unit
C_{iss}	Input Capacitance	$V_{GS} = 0V$ $V_{DS} = 25V$ $f = 1MHz$		28.9		nF
C_{oss}	Output Capacitance			4.4		
C_{rss}	Reverse Transfer Capacitance			0.8		
Q_g	Total gate Charge	$V_{GS} = 10V$ $V_{Bus} = 600V$ $I_D = 116A$		1100		nC
Q_{gs}	Gate - Source Charge			128		
Q_{gd}	Gate - Drain Charge			716		
$T_{d(on)}$	Turn-on Delay Time	Inductive switching @ 125°C $V_{GS} = 15V$ $V_{Bus} = 800V$ $I_D = 116A$ $R_G = 1.2\Omega$		20		ns
T_r	Rise Time			17		
$T_{d(off)}$	Turn-off Delay Time			245		
T_f	Fall Time			62		
E_{on}	Turn-on Switching Energy ❶	Inductive switching @ 25°C $V_{GS} = 15V, V_{Bus} = 800V$ $I_D = 116A, R_G = 1.2\Omega$		5		mJ
E_{off}	Turn-off Switching Energy ❷			4.6		
E_{on}	Turn-on Switching Energy ❶	Inductive switching @ 125°C $V_{GS} = 15V, V_{Bus} = 800V$ $I_D = 116A, R_G = 1.2\Omega$		9.2		mJ
E_{off}	Turn-off Switching Energy ❷			5.6		

❶ E_{on} includes diode reverse recovery.

❷ In accordance with JEDEC standard JESD24-1.

Series diode ratings and characteristics

Symbol	Characteristic	Test Conditions	Min	Typ	Max	Unit
V_{RRM}	Maximum Repetitive Reverse Voltage		1200			V
$I_{F(AV)}$	Maximum Average Forward Current	50% duty cycle $T_c = 70^\circ\text{C}$		180		A
V_F	Diode Forward Voltage	$I_F = 180A$		2	2.5	V
		$I_F = 360A$		2.3		
		$I_F = 180A$ $T_j = 125^\circ\text{C}$		1.8		
t_{rr}	Reverse Recovery Time	$I_F = 180A$ $V_R = 800V$ $di/dt = 800A/\mu s$ $T_j = 25^\circ\text{C}$		370		ns
		$T_j = 125^\circ\text{C}$		500		
Q_{rr}	Reverse Recovery Charge	$I_F = 180A$ $V_R = 800V$ $di/dt = 800A/\mu s$ $T_j = 25^\circ\text{C}$		3.9		μC
		$T_j = 125^\circ\text{C}$		20.7		

Thermal and package characteristics

Symbol Characteristic

Min Typ Max Unit

<i>Symbol</i>	<i>Characteristic</i>	<i>Min</i>	<i>Typ</i>	<i>Max</i>	<i>Unit</i>	
R _{thJC}	Junction to Case	Transistor		0.038	°C/W	
		Series diode		0.22		
V _{ISOL}	RMS Isolation Voltage, any terminal to case t = 1 min, I _{isol} < 1mA, 50/60Hz	2500			V	
T _J	Operating junction temperature range	-40		150	°C	
T _{STG}	Storage Temperature Range	-40		125		
T _C	Operating Case Temperature	-40		100		
Torque	Mounting torque	To heatsink	M6	3	5	N.m
		For terminals	M5	2	3.5	
Wt	Package Weight			280	g	

Package outline

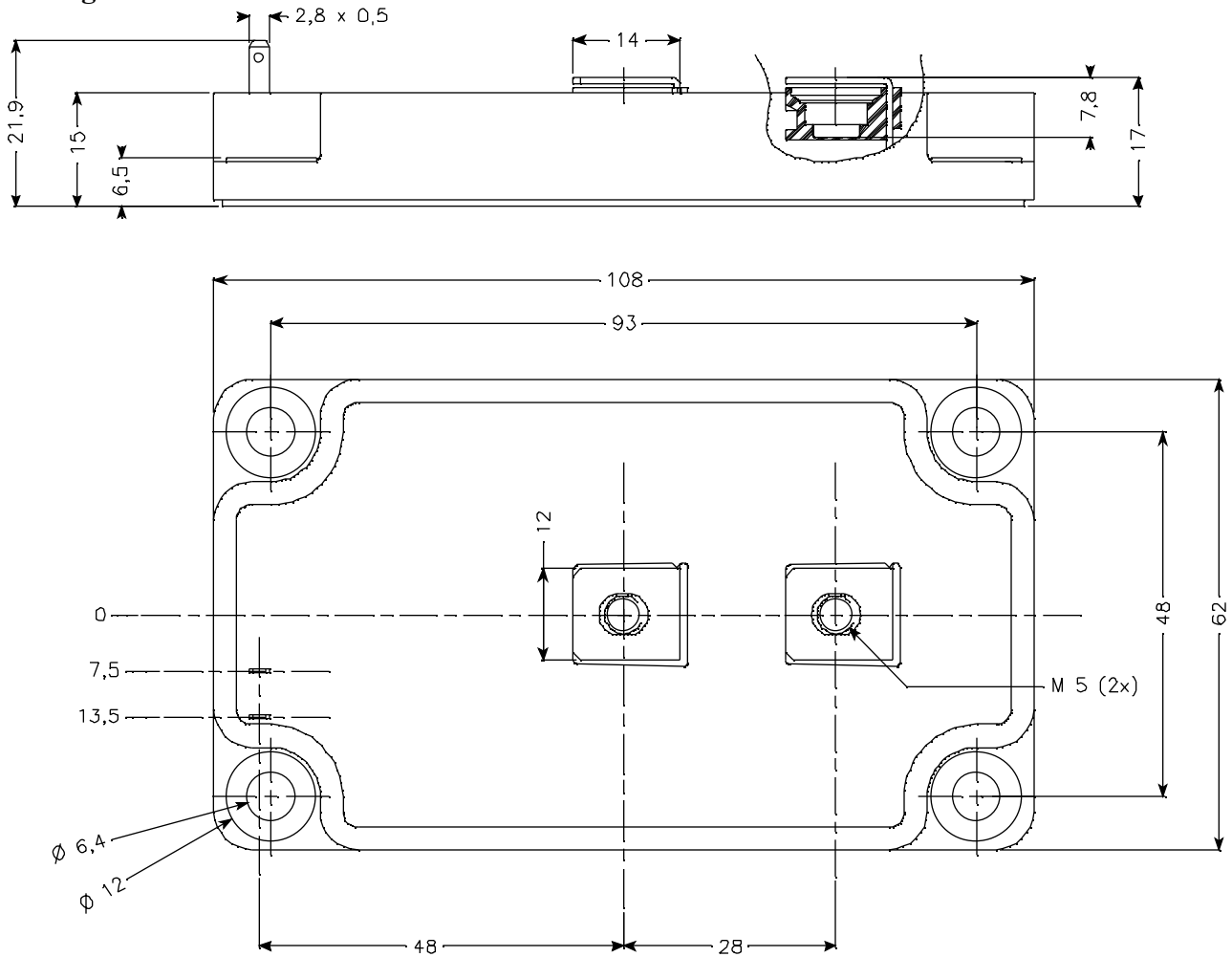

Typical Performance Curve

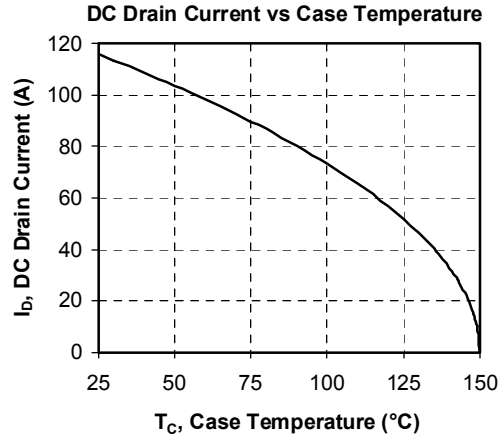
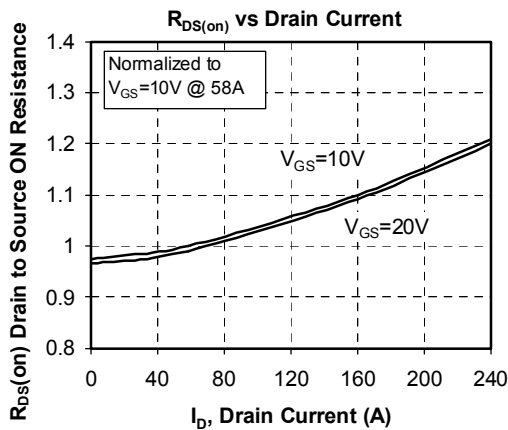
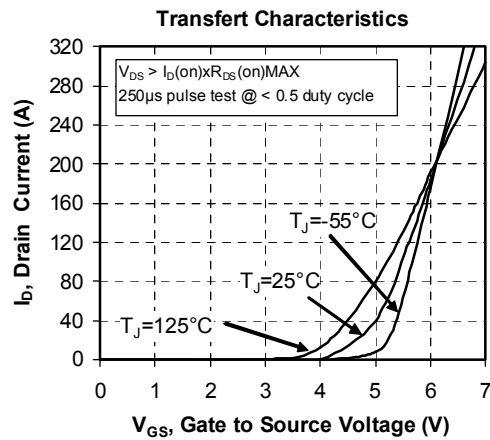
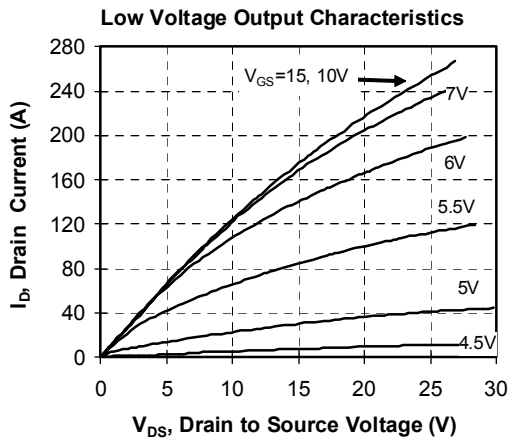
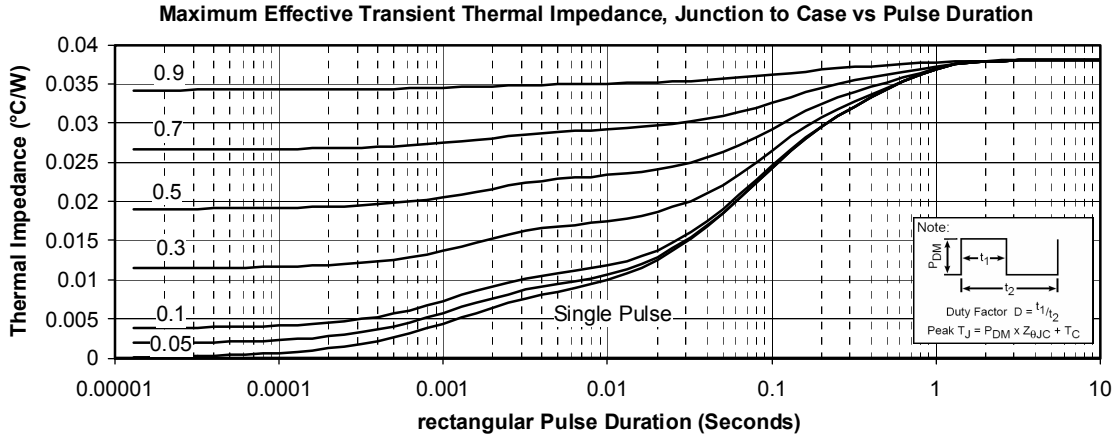

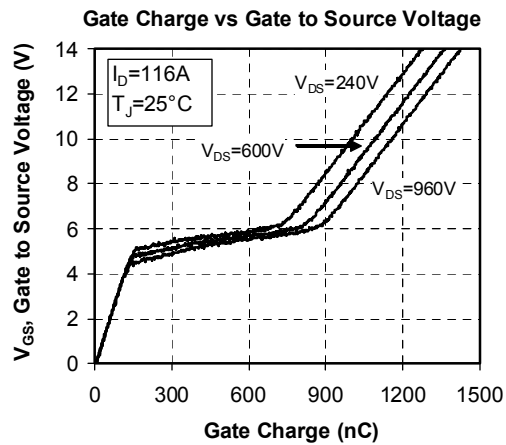
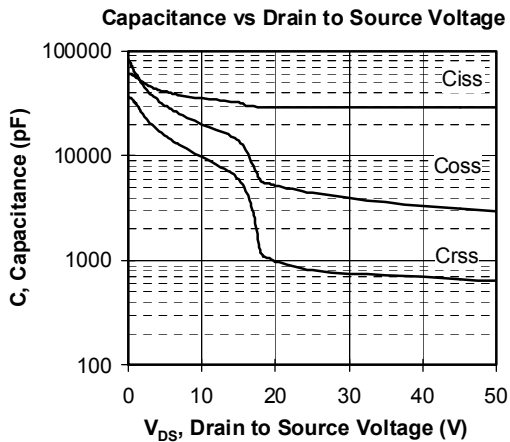
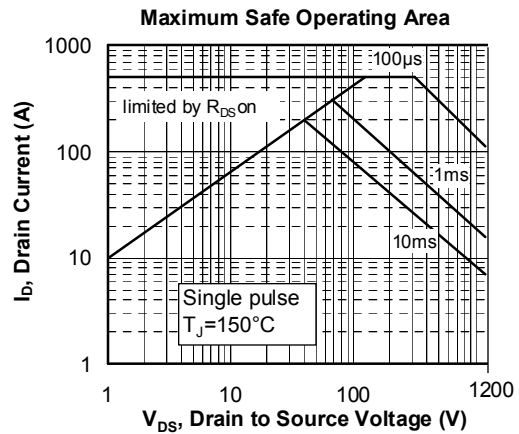
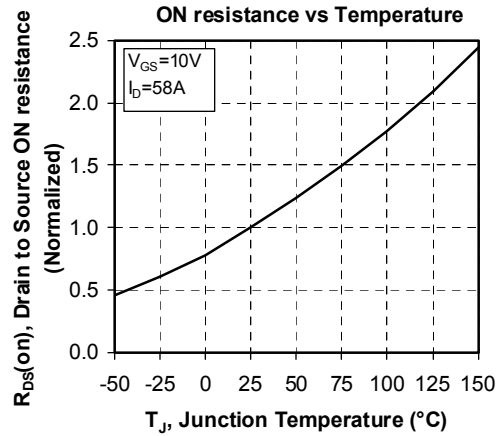

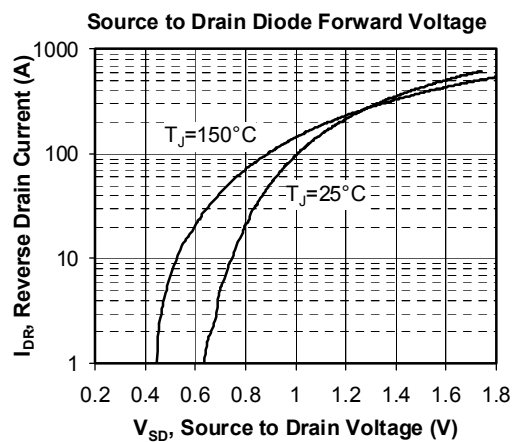
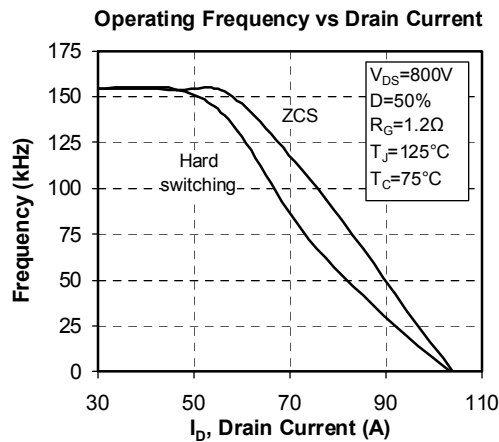
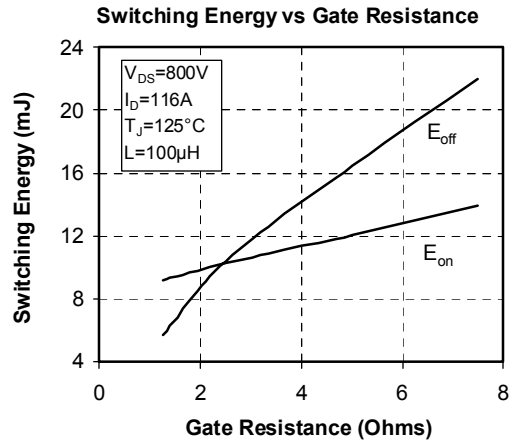
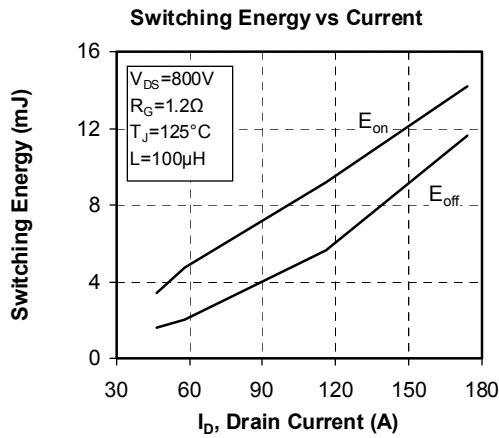
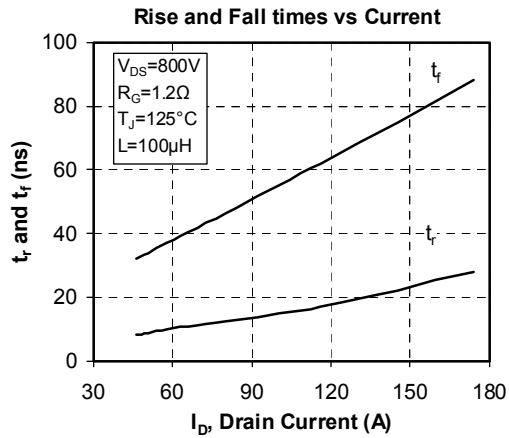
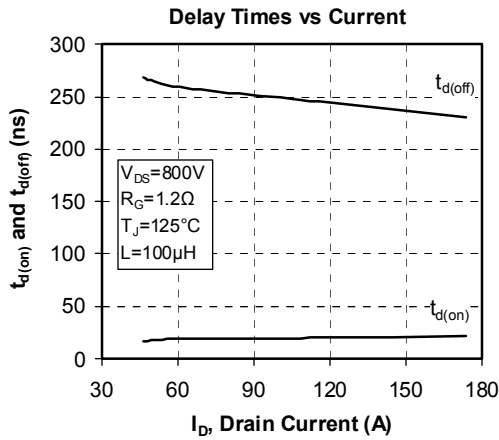

APT reserves the right to change, without notice, the specifications and information contained herein

APT's products are covered by one or more of U.S. patents 4,895,810 5,045,903 5,089,434 5,182,234 5,019,522 5,262,336 6,503,786 5,256,583 4,748,103 5,283,202 5,231,474 5,434,095 5,528,058 and foreign patents. U.S. and Foreign patents pending. All Rights Reserved.