

**Full - Bridge
MOSFET Power Module**

**$V_{DSS} = 1000V$
 $R_{DSon} = 180m\Omega$ max @ $T_j = 25^\circ C$
 $I_D = 43A$ @ $T_c = 25^\circ C$**

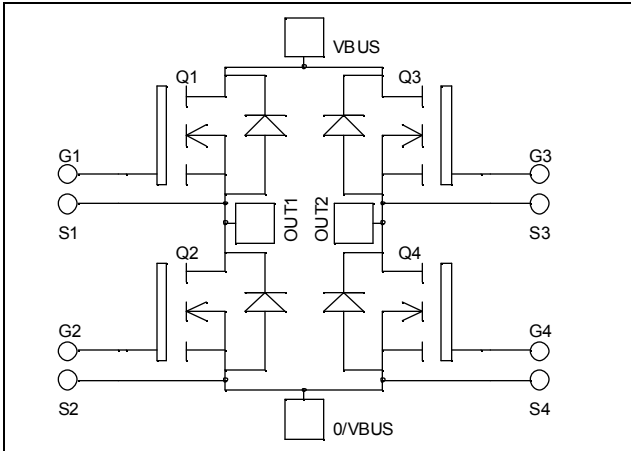

Application

- Welding converters
- Switched Mode Power Supplies
- Uninterruptible Power Supplies
- Motor control

Features

- Power MOS 7® FREDFETs
 - Low R_{DSon}
 - Low input and Miller capacitance
 - Low gate charge
 - Fast intrinsic reverse diode
 - Avalanche energy rated
 - Very rugged
- Kelvin source for easy drive
- Very low stray inductance
 - Symmetrical design
 - M5 power connectors
- High level of integration

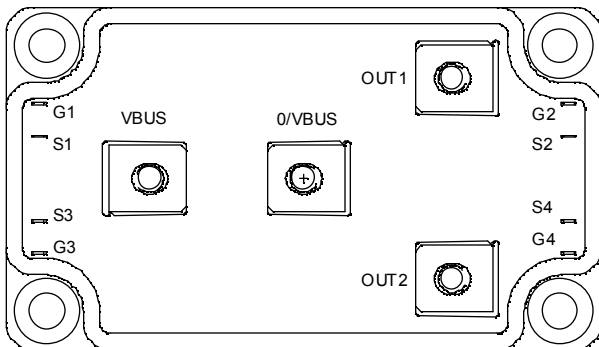

Benefits

- Outstanding performance at high frequency operation
- Direct mounting to heatsink (isolated package)
- Low junction to case thermal resistance
- Low profile

Absolute maximum ratings

Symbol	Parameter	Max ratings	Unit
V_{DSS}	Drain - Source Breakdown Voltage	1000	V
I_D	Continuous Drain Current	$T_c = 25^\circ C$	43
		$T_c = 80^\circ C$	33
I_{DM}	Pulsed Drain current	172	
V_{GS}	Gate - Source Voltage	± 30	V
R_{DSon}	Drain - Source ON Resistance	180	$m\Omega$
P_D	Maximum Power Dissipation	$T_c = 25^\circ C$	780
I_{AR}	Avalanche current (repetitive and non repetitive)	25	A
E_{AR}	Repetitive Avalanche Energy	50	mJ
E_{AS}	Single Pulse Avalanche Energy	3000	

CAUTION: These Devices are sensitive to Electrostatic Discharge. Proper Handling Procedures Should Be Followed.

All ratings @ $T_j = 25^\circ\text{C}$ unless otherwise specified

Electrical Characteristics

Symbol	Characteristic	Test Conditions	Min	Typ	Max	Unit
BV_{DSS}	Drain - Source Breakdown Voltage	$V_{GS} = 0V, I_D = 500\mu A$	1000			V
I_{DSS}	Zero Gate Voltage Drain Current	$V_{GS} = 0V, V_{DS} = 1000V, T_j = 25^\circ\text{C}$			500	μA
		$V_{GS} = 0V, V_{DS} = 800V, T_j = 125^\circ\text{C}$			2000	
$R_{DS(on)}$	Drain - Source on Resistance	$V_{GS} = 10V, I_D = 21.5A$			180	$m\Omega$
$V_{GS(th)}$	Gate Threshold Voltage	$V_{GS} = V_{DS}, I_D = 5mA$	3		5	V
I_{GSS}	Gate - Source Leakage Current	$V_{GS} = \pm 30V, V_{DS} = 0V$			± 150	nA

Dynamic Characteristics

Symbol	Characteristic	Test Conditions	Min	Typ	Max	Unit
C_{iss}	Input Capacitance	$V_{GS} = 0V, V_{DS} = 25V, f = 1MHz$		10.4		nF
C_{oss}	Output Capacitance			1.76		
C_{rss}	Reverse Transfer Capacitance			0.32		
Q_g	Total gate Charge	$V_{GS} = 10V, V_{Bus} = 500V, I_D = 43A$		372		nC
Q_{gs}	Gate - Source Charge			48		
Q_{gd}	Gate - Drain Charge			244		
$T_{d(on)}$	Turn-on Delay Time	Inductive switching @ 125°C $V_{GS} = 15V, V_{Bus} = 670V, I_D = 43A, R_G = 2.5\Omega$		18		ns
T_r	Rise Time			12		
$T_{d(off)}$	Turn-off Delay Time			155		
T_f	Fall Time			40		
E_{on}	Turn-on Switching Energy ❶	Inductive switching @ 25°C $V_{GS} = 15V, V_{Bus} = 670V, I_D = 43A, R_G = 2.5\Omega$		1800		μJ
E_{off}	Turn-off Switching Energy ❷			1246		
E_{on}	Turn-on Switching Energy ❶	Inductive switching @ 125°C $V_{GS} = 15V, V_{Bus} = 670V, I_D = 43A, R_G = 2.5\Omega$		2846		μJ
E_{off}	Turn-off Switching Energy ❷			1558		

Source - Drain diode ratings and characteristics

Symbol	Characteristic	Test Conditions	Min	Typ	Max	Unit	
I_S	Continuous Source current (Body diode)	$T_c = 25^\circ\text{C}$			43	A	
		$T_c = 80^\circ\text{C}$			33		
V_{SD}	Diode Forward Voltage	$V_{GS} = 0V, I_S = -43A$			1.3	V	
dv/dt	Peak Diode Recovery ❸				18	V/ns	
t_{rr}	Reverse Recovery Time	$I_S = -43A, V_R = 500V, di_S/dt = 200A/\mu s$	$T_j = 25^\circ\text{C}$			320	ns
			$T_j = 125^\circ\text{C}$			650	
Q_{rr}	Reverse Recovery Charge	$I_S = -43A, V_R = 500V, di_S/dt = 200A/\mu s$	$T_j = 25^\circ\text{C}$		7.2	μC	
			$T_j = 125^\circ\text{C}$		19.5		

❶ E_{on} includes diode reverse recovery.

❷ In accordance with JEDEC standard JESD24-1.

❸ dv/dt numbers reflect the limitations of the circuit rather than the device itself.

$$I_S \leq -43A \quad di/dt \leq 700A/\mu s \quad V_R \leq V_{DSS} \quad T_j \leq 150^\circ\text{C}$$

Typical Performance Curve

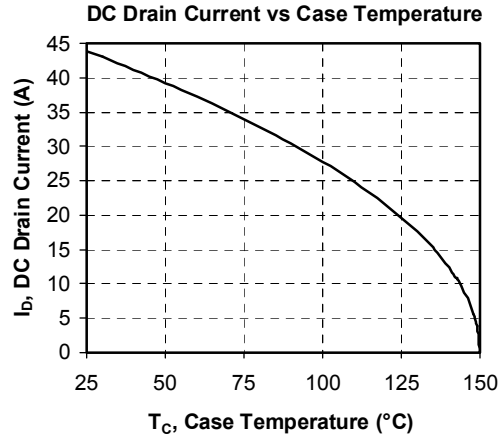
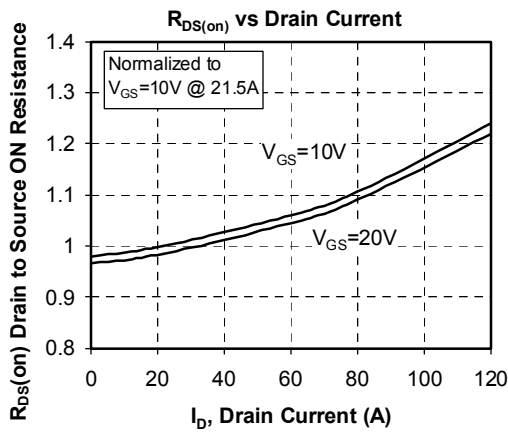
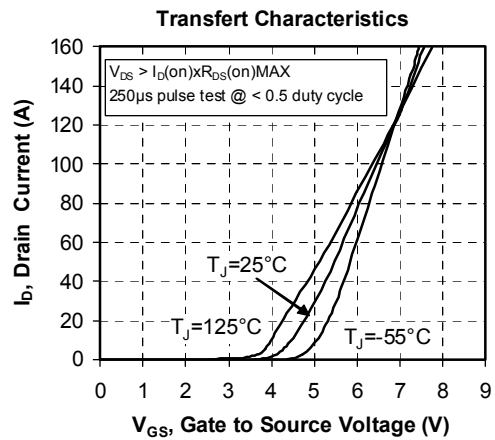
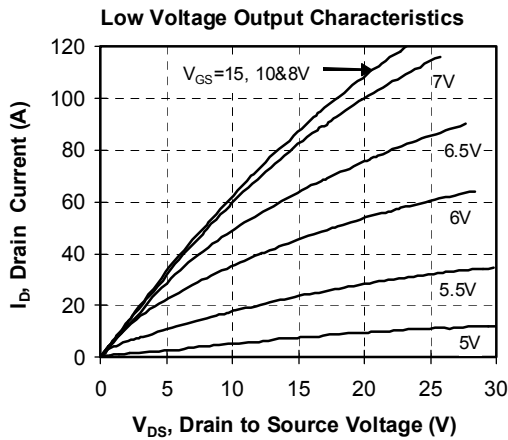
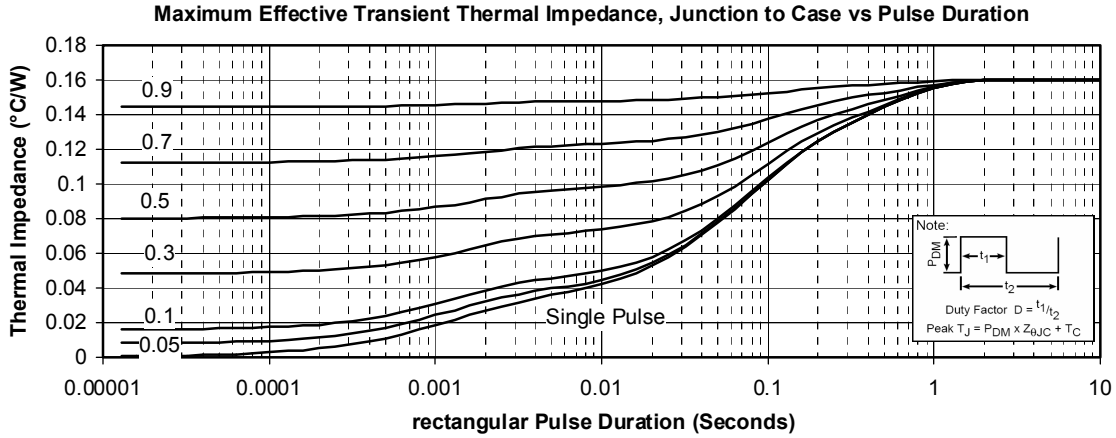

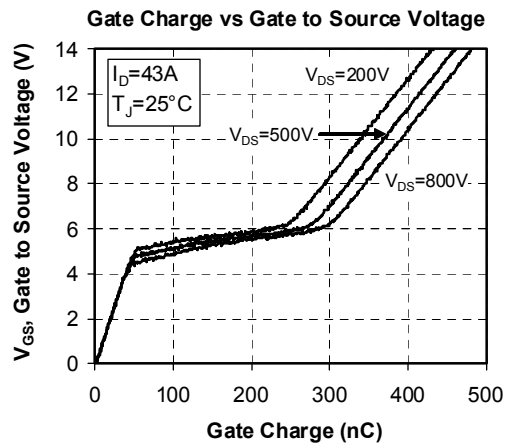
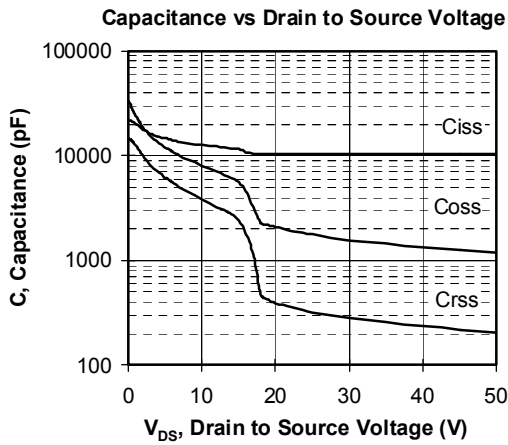
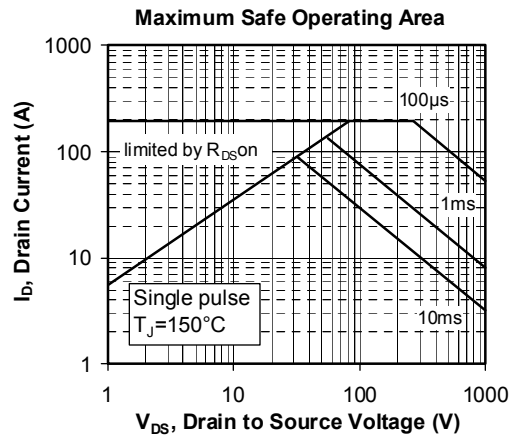
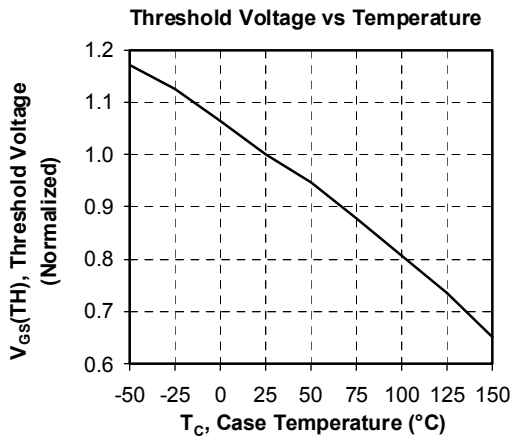
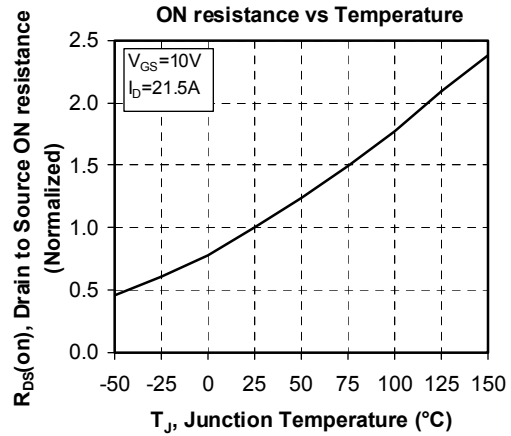
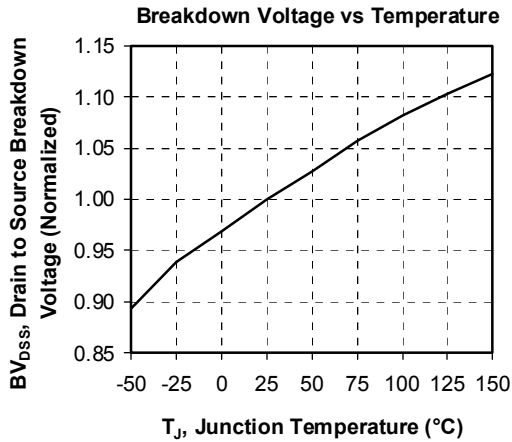

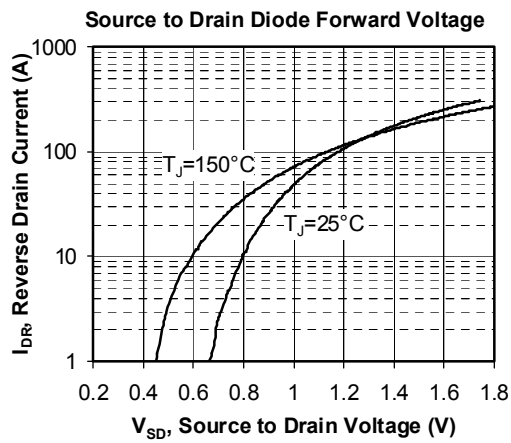
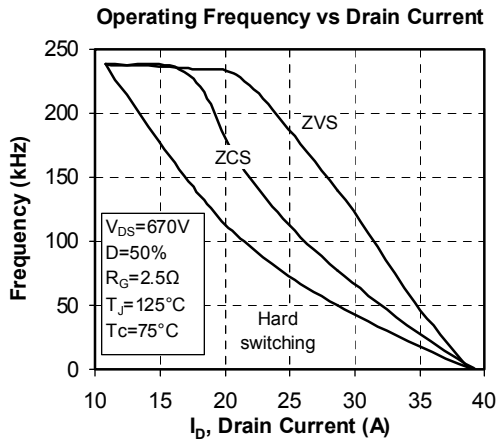
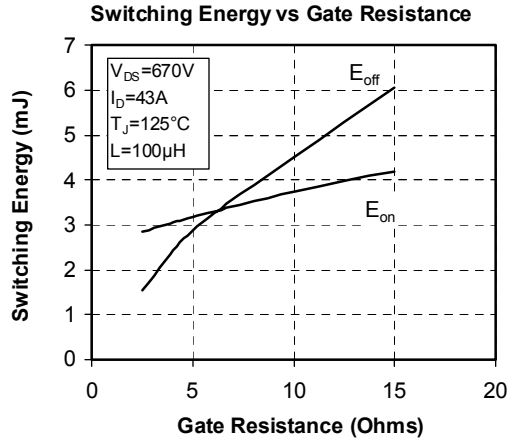
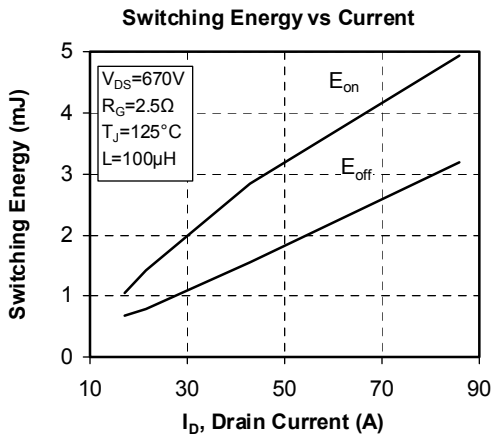
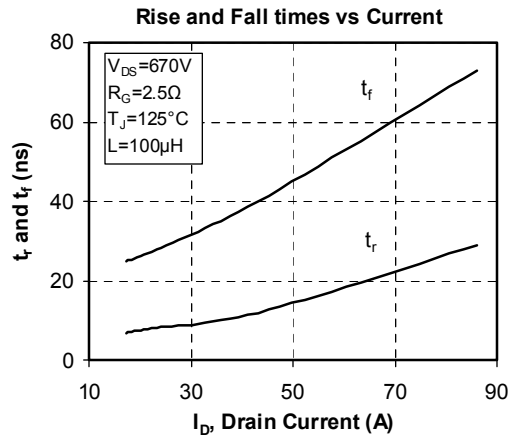
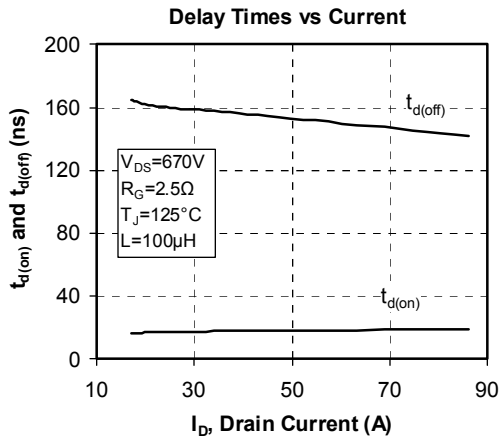

APT reserves the right to change, without notice, the specifications and information contained herein

APT's products are covered by one or more of U.S. patents 4,895,810 5,045,903 5,089,434 5,182,234 5,019,522 5,262,336 6,503,786 5,256,583 4,748,103 5,283,202 5,231,474 5,434,095 5,528,058 and foreign patents. U.S. and Foreign patents pending. All Rights Reserved.