

**Buck chopper
Fast Trench + Field Stop IGBT®
Power Module**

**$V_{CES} = 1200V$
 $I_C = 150A @ T_c = 80°C$**

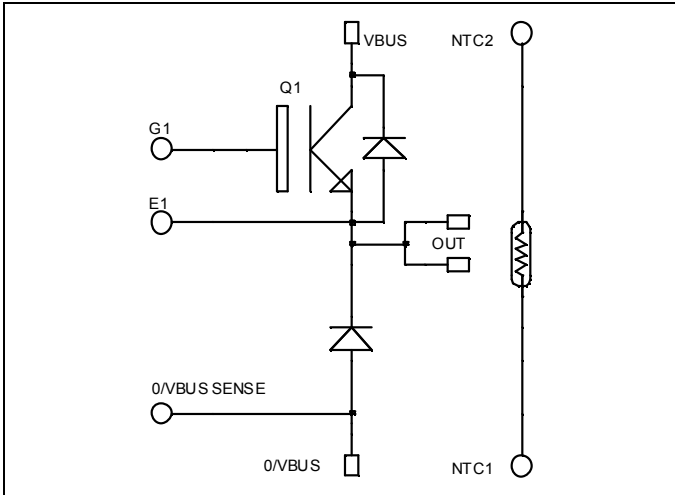

Application

- AC and DC motor control
- Switched Mode Power Supplies

Features

- Fast Trench + Field Stop IGBT® Technology
 - Low voltage drop
 - Low tail current
 - Switching frequency up to 20 kHz
 - Soft recovery parallel diodes
 - Low diode VF
 - Low leakage current
 - Avalanche energy rated
 - RBSOA and SCSOA rated
- Kelvin emitter for easy drive
- Very low stray inductance
 - Symmetrical design
 - Lead frames for power connections
- High level of integration
- Internal thermistor for temperature monitoring

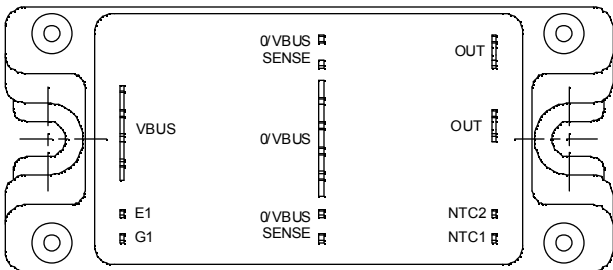

Benefits

- Stable temperature behavior
- Very rugged
- Solderable terminals for easy PCB mounting
- Direct mounting to heatsink (isolated package)
- Low junction to case thermal resistance
- Easy paralleling due to positive TC of VCEsat
- Low profile

Absolute maximum ratings

Symbol	Parameter	Max ratings	Unit
V_{CES}	Collector - Emitter Breakdown Voltage	1200	V
I_C	Continuous Collector Current	$T_c = 25°C$	220
		$T_c = 80°C$	150
I_{CM}	Pulsed Collector Current	$T_c = 25°C$	350
V_{GE}	Gate - Emitter Voltage	± 20	V
P_D	Maximum Power Dissipation	$T_c = 25°C$	690
RBSOA	Reverse Bias Safe Operating Area	$T_j = 125°C$	300A @ 1150V

CAUTION: These Devices are sensitive to Electrostatic Discharge. Proper Handling Procedures Should Be Followed.

All ratings @ $T_j = 25^\circ\text{C}$ unless otherwise specified

Electrical Characteristics

Symbol	Characteristic	Test Conditions	Min	Typ	Max	Unit
I_{CES}	Zero Gate Voltage Collector Current	$V_{GE} = 0\text{V}, V_{CE} = 1200\text{V}$			350	μA
$V_{CE(sat)}$	Collector Emitter Saturation Voltage	$V_{GE} = 15\text{V}$ $I_C = 150\text{A}$	$T_j = 25^\circ\text{C}$	1.7	2.1	V
			$T_j = 125^\circ\text{C}$	2.0		
$V_{GE(th)}$	Gate Threshold Voltage	$V_{GE} = V_{CE}, I_C = 3\text{mA}$	5.0	5.8	6.5	V
I_{GES}	Gate – Emitter Leakage Current	$V_{GE} = 20\text{V}, V_{CE} = 0\text{V}$			600	nA

Dynamic Characteristics

Symbol	Characteristic	Test Conditions	Min	Typ	Max	Unit
C_{ies}	Input Capacitance	$V_{GE} = 0\text{V}$		10.7		nF
C_{oes}	Output Capacitance	$V_{CE} = 25\text{V}$		0.56		
C_{res}	Reverse Transfer Capacitance	$f = 1\text{MHz}$		0.48		
$T_{d(on)}$	Turn-on Delay Time	Inductive Switching (25°C) $V_{GE} = \pm 15\text{V}$ $V_{Bus} = 600\text{V}$ $I_C = 150\text{A}$ $R_G = 2.2\Omega$		280		ns
T_r	Rise Time			40		
$T_{d(off)}$	Turn-off Delay Time			450		
T_f	Fall Time			75		
$T_{d(on)}$	Turn-on Delay Time	Inductive Switching (125°C) $V_{GE} = \pm 15\text{V}$ $V_{Bus} = 600\text{V}$ $I_C = 150\text{A}$ $R_G = 2.2\Omega$		290		ns
T_r	Rise Time			45		
$T_{d(off)}$	Turn-off Delay Time			550		
T_f	Fall Time			90		
E_{on}	Turn-on Switching Energy			14		mJ
E_{off}	Turn-off Switching Energy			16		

Chopper diode ratings and characteristics

Symbol	Characteristic	Test Conditions	Min	Typ	Max	Unit
V_{RRM}	Maximum Peak Repetitive Reverse Voltage		1200			V
I_{RM}	Maximum Reverse Leakage Current	$V_R = 1200\text{V}$	$T_j = 25^\circ\text{C}$		250	μA
			$T_j = 125^\circ\text{C}$		500	
$I_{F(AV)}$	Maximum Average Forward Current	50% duty cycle		150		A
V_F	Diode Forward Voltage	$I_F = 150\text{A}$	$T_j = 25^\circ\text{C}$	1.6	2.1	V
			$T_j = 125^\circ\text{C}$	1.6		
t_{rr}	Reverse Recovery Time	$I_F = 150\text{A}$ $V_R = 600\text{V}$	$T_j = 25^\circ\text{C}$	170		ns
			$T_j = 125^\circ\text{C}$	280		
Q_{rr}	Reverse Recovery Charge	$di/dt = 3000\text{A}/\mu\text{s}$	$T_j = 25^\circ\text{C}$	15		μC
			$T_j = 125^\circ\text{C}$	29		

Temperature sensor NTC (see application note APT0406 on www.advancedpower.com for more information).

Symbol	Characteristic	Min	Typ	Max	Unit
R ₂₅	Resistance @ 25°C		50		kΩ
B _{25/85}	T ₂₅ = 298.15 K		3952		K

$$R_T = \frac{R_{25}}{\exp\left[B_{25/85}\left(\frac{1}{T_{25}} - \frac{1}{T}\right)\right]}$$

T: Thermistor temperature
R_T: Thermistor value at T

Thermal and package characteristics

Symbol	Characteristic	Min	Typ	Max	Unit	
R _{thJC}	Junction to Case	IGBT		0.18	°C/W	
		Diode		0.32		
V _{ISOL}	RMS Isolation Voltage, any terminal to case t=1 min, I _{isol} <1mA, 50/60Hz	2500			V	
T _J	Operating junction temperature range	-40		150	°C	
T _{STG}	Storage Temperature Range	-40		125		
T _C	Operating Case Temperature	-40		125		
Torque	Mounting torque	To Heatsink	M5	1.5	4.7	N.m
Wt	Package Weight			160		g

Package outline (dimensions in mm)

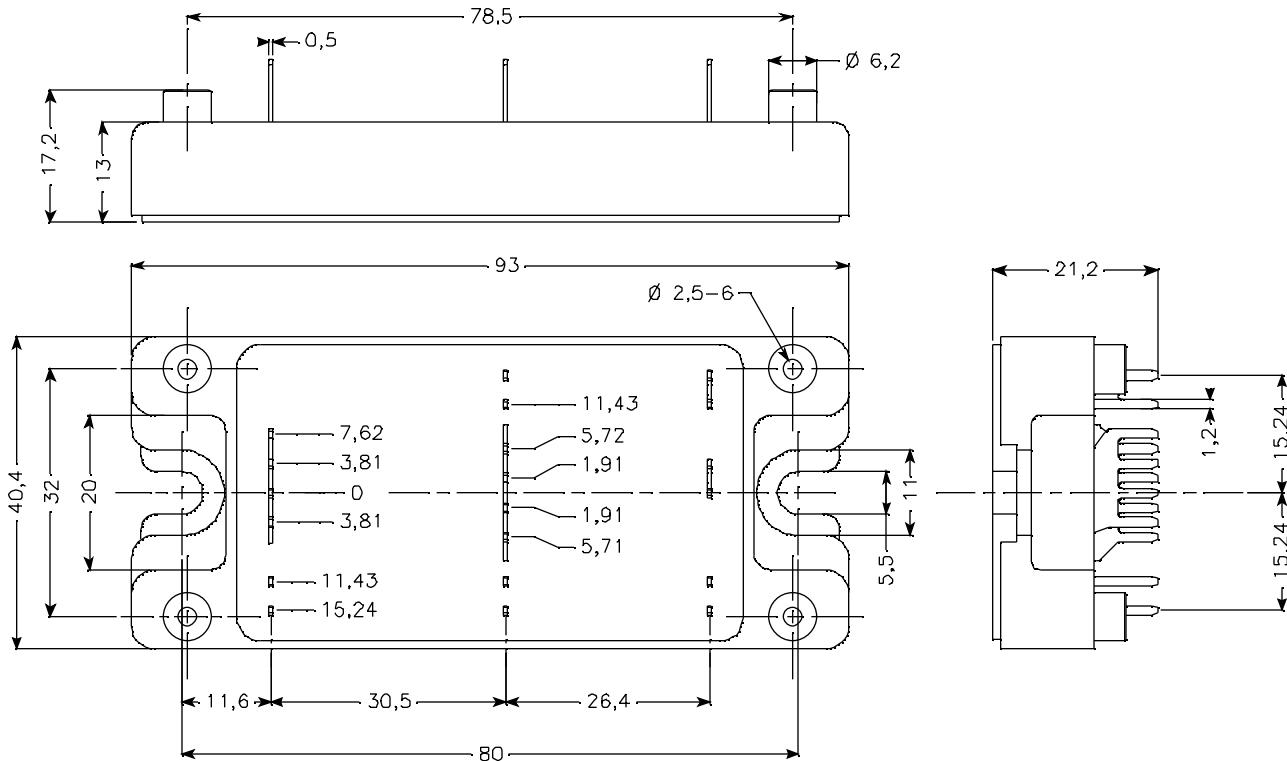

Typical Performance Curve

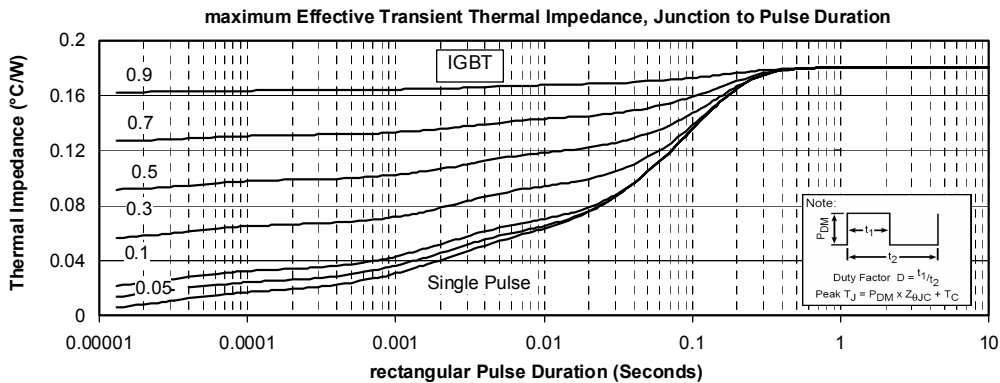
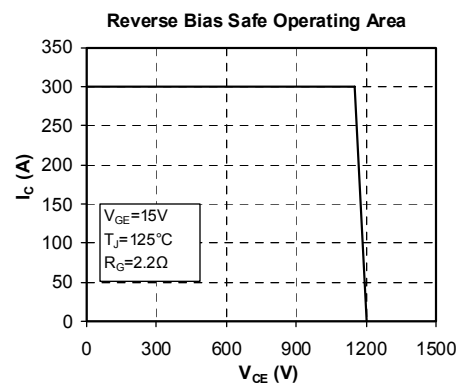
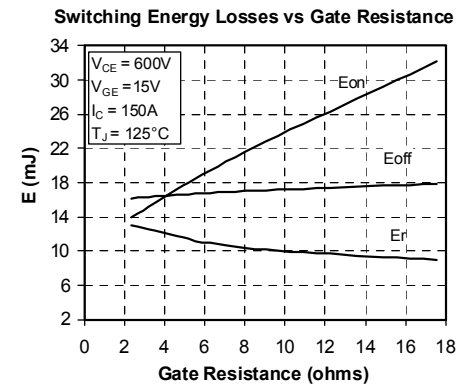
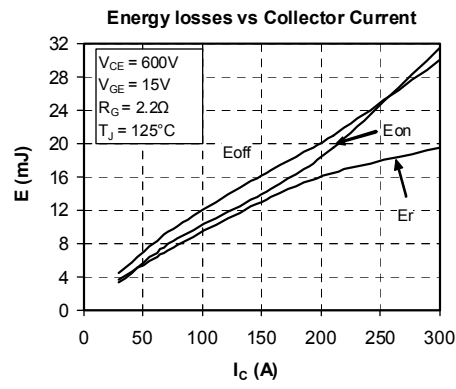
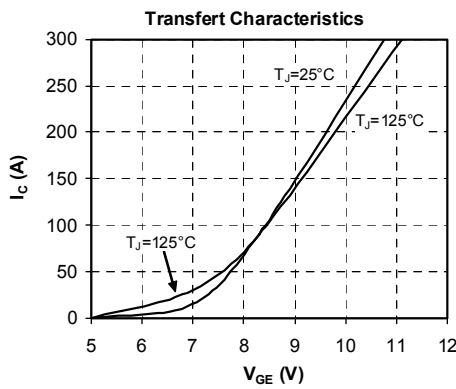
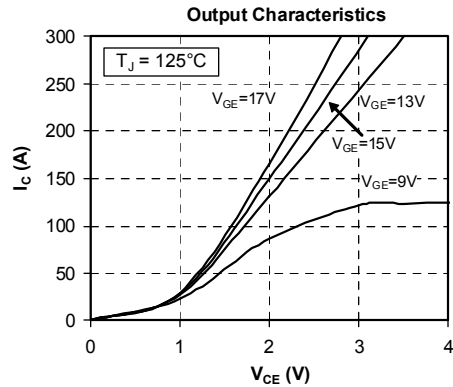
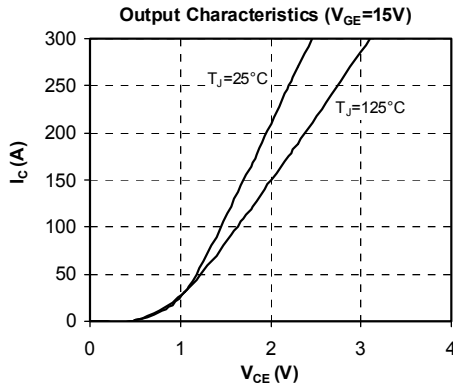

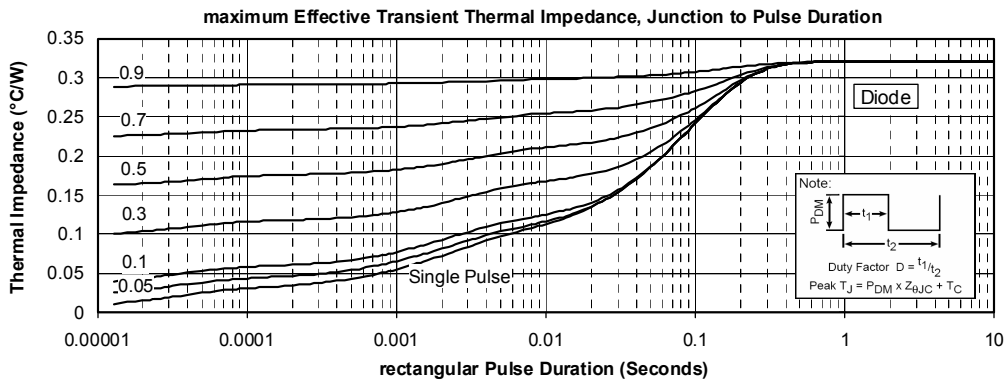
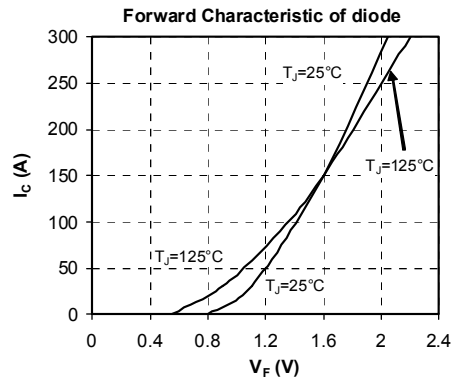
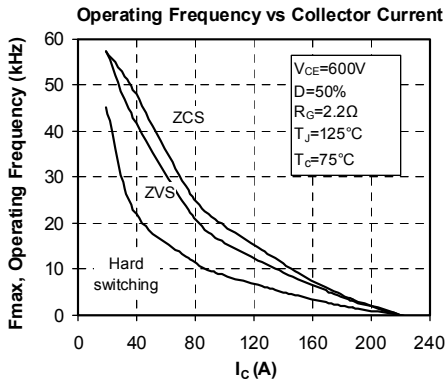

APT reserves the right to change, without notice, the specifications and information contained herein

APT's products are covered by one or more of U.S. patents 4,895,810 5,045,903 5,089,434 5,182,234 5,019,522 5,262,336 6,503,786 5,256,583 4,748,103 5,283,202 5,231,474 5,434,095 5,528,058 and foreign patents. U.S and Foreign patents pending. All Rights Reserved.