

Boost chopper NPT IGBT Power Module

$V_{CES} = 1200V$
 $I_C = 100A @ T_c = 80^\circ C$

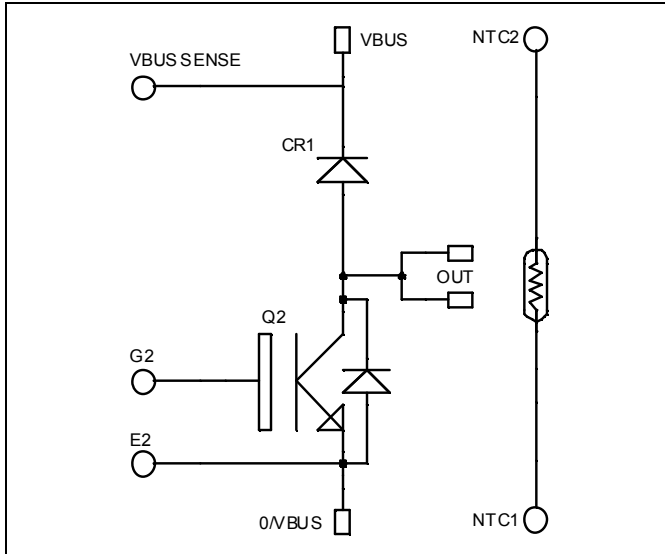

Application

- AC and DC motor control
- Switched Mode Power Supplies
- Power Factor Correction

Features

- Non Punch Through (NPT) Fast IGBT®
 - Low voltage drop
 - Low tail current
 - Switching frequency up to 50 kHz
 - Soft recovery parallel diodes
 - Low diode VF
 - Low leakage current
 - Avalanche energy rated
 - RBSOA and SCSOA rated
- Kelvin emitter for easy drive
- Very low stray inductance
 - Symmetrical design
 - Lead frames for power connections
- Internal thermistor for temperature monitoring
- High level of integration

Benefits

- Outstanding performance at high frequency operation
- Stable temperature behavior
- Very rugged
- Direct mounting to heatsink (isolated package)
- Low junction to case thermal resistance
- Solderable terminals both for power and signal for easy PCB mounting
- Easy paralleling due to positive T_c of V_{CESat}
- Low profile
- RoHS compliant

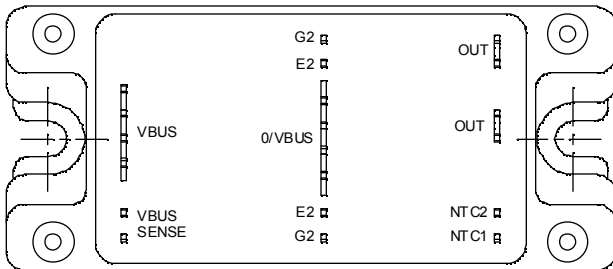

Absolute maximum ratings

Symbol	Parameter	Max ratings	Unit
V_{CES}	Collector - Emitter Breakdown Voltage	1200	V
I_C	Continuous Collector Current	$T_c = 25^\circ C$	135
		$T_c = 80^\circ C$	100
I_{CM}	Pulsed Collector Current	$T_c = 25^\circ C$	300
V_{GE}	Gate - Emitter Voltage	± 20	V
P_D	Maximum Power Dissipation	$T_c = 25^\circ C$	568
RBSOA	Reverse Bias Safe Operating Area	$T_j = 150^\circ C$	200A @ 1200V

CAUTION: These Devices are sensitive to Electrostatic Discharge. Proper Handling Procedures Should Be Followed. See application note APT0502 on www.microsemi.com

All ratings @ $T_j = 25^\circ\text{C}$ unless otherwise specified

Electrical Characteristics

Symbol	Characteristic	Test Conditions	Min	Typ	Max	Unit
I_{CES}	Zero Gate Voltage Collector Current	$V_{GE} = 0\text{V}$ $V_{CE} = 1200\text{V}$			350 600	μA
$V_{CE(sat)}$	Collector Emitter Saturation Voltage	$V_{GE} = 15\text{V}$ $I_C = 100\text{A}$		3.2 4.0	3.7	V
$V_{GE(th)}$	Gate Threshold Voltage	$V_{GE} = V_{CE}, I_C = 2\text{ mA}$	4.5		6.5	V
I_{GES}	Gate – Emitter Leakage Current	$V_{GE} = 20\text{ V}, V_{CE} = 0\text{V}$			150	nA

Dynamic Characteristics

Symbol	Characteristic	Test Conditions	Min	Typ	Max	Unit
C_{ies}	Input Capacitance	$V_{GE} = 0\text{V}$		6900		pF
C_{oes}	Output Capacitance	$V_{CE} = 25\text{V}$		660		
C_{res}	Reverse Transfer Capacitance	$f = 1\text{MHz}$		440		
Q_g	Total gate Charge	$V_{GS} = 15\text{V}$		660		nC
Q_{gc}	Gate – Emitter Charge	$V_{Bus} = 600\text{V}$		70		
Q_{gc}	Gate – Collector Charge	$I_C = 100\text{A}$		400		
$T_{d(on)}$	Turn-on Delay Time	Inductive Switching (25°C)		35		ns
T_r	Rise Time	$V_{GE} = 15\text{V}$ $V_{Bus} = 600\text{V}$		65		
$T_{d(off)}$	Turn-off Delay Time	$I_C = 100\text{A}$		320		
T_f	Fall Time	$R_G = 2.5\ \Omega$		30		
$T_{d(on)}$	Turn-on Delay Time	Inductive Switching (125°C)		35		ns
T_r	Rise Time	$V_{GE} = 15\text{V}$ $V_{Bus} = 600\text{V}$		65		
$T_{d(off)}$	Turn-off Delay Time	$I_C = 100\text{A}$		360		
T_f	Fall Time	$R_G = 2.5\ \Omega$		40		
E_{on}	Turn-on Switching Energy	$V_{GE} = 15\text{V}$ $V_{Bus} = 600\text{V}$	$T_j = 125^\circ\text{C}$	13.9		mJ
E_{off}	Turn-off Switching Energy	$I_C = 100\text{A}$ $R_G = 2.5\ \Omega$	$T_j = 125^\circ\text{C}$	6.1		

Chopper diode ratings and characteristics

Symbol	Characteristic	Test Conditions	Min	Typ	Max	Unit
V_{RRM}	Maximum Peak Repetitive Reverse Voltage		1200			V
I_{RM}	Maximum Reverse Leakage Current	$V_R = 1200\text{V}$			350 600	μA
I_F	DC Forward Current			120		A
V_F	Diode Forward Voltage	$I_F = 120\text{A}$		2.0	2.5	V
		$I_F = 240\text{A}$		2.3		
		$I_F = 120\text{A}$ $T_j = 125^\circ\text{C}$		1.8		
t_{rr}	Reverse Recovery Time	$I_F = 120\text{A}$ $V_R = 800\text{V}$	$T_j = 25^\circ\text{C}$	400		ns
			$T_j = 125^\circ\text{C}$	470		
Q_{rr}	Reverse Recovery Charge	$di/dt = 400\text{A}/\mu\text{s}$	$T_j = 25^\circ\text{C}$	2400		nC
			$T_j = 125^\circ\text{C}$	8000		

Typical Performance Curve

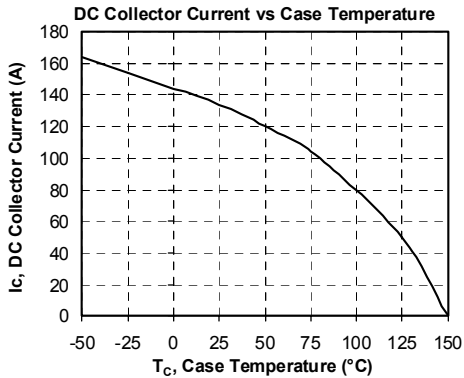
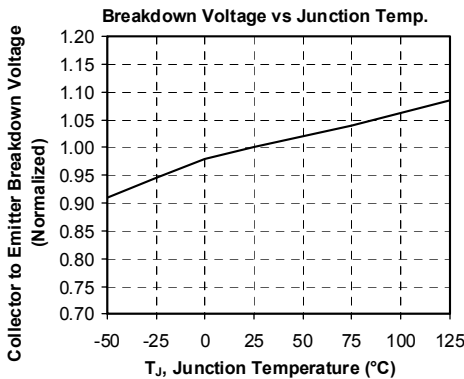
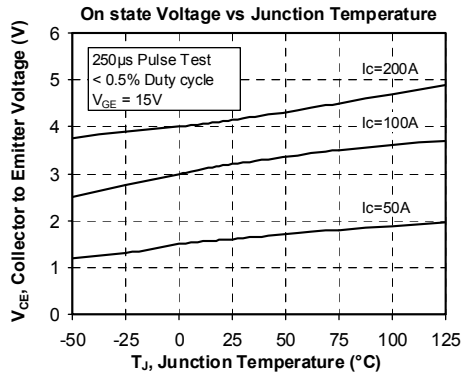
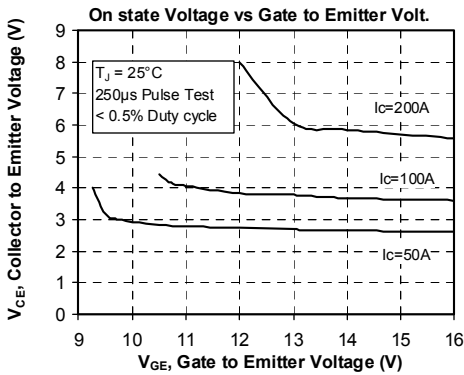
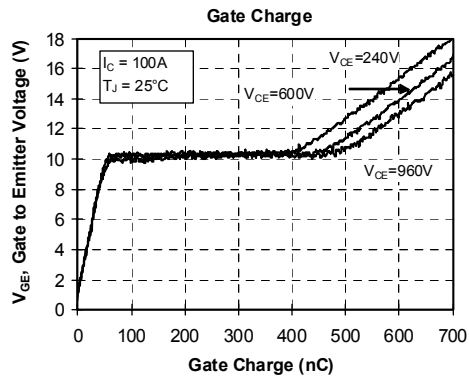
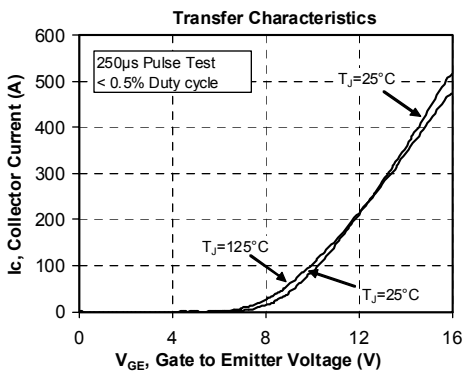
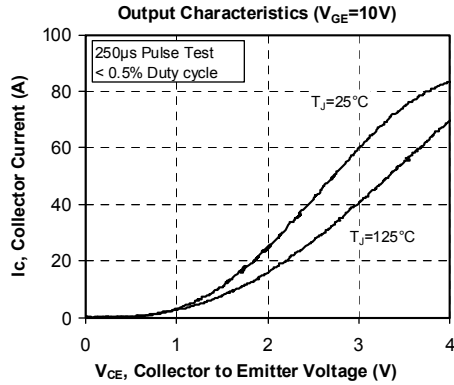
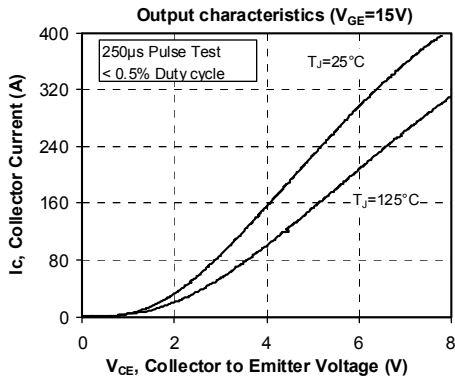

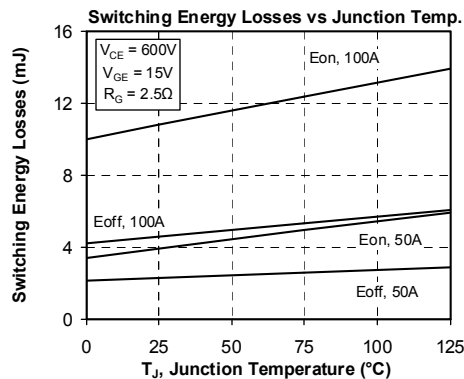
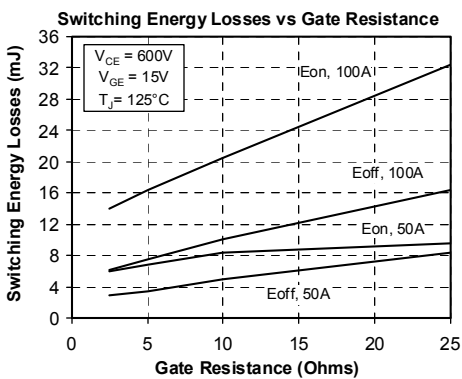
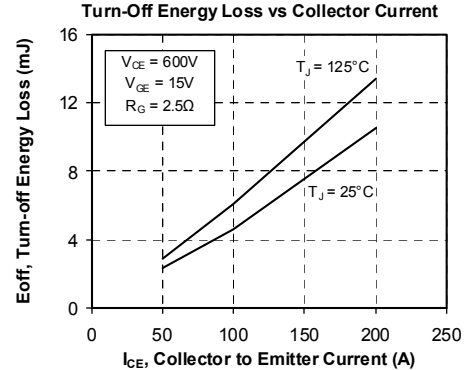
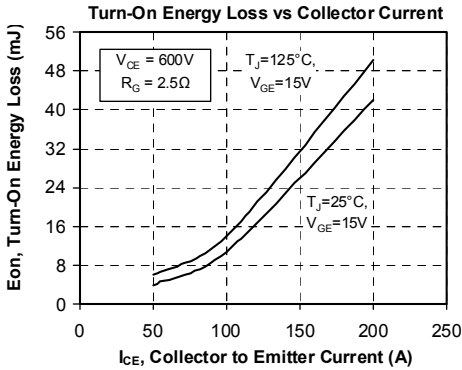
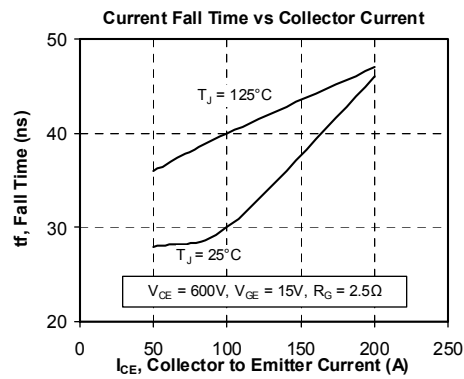
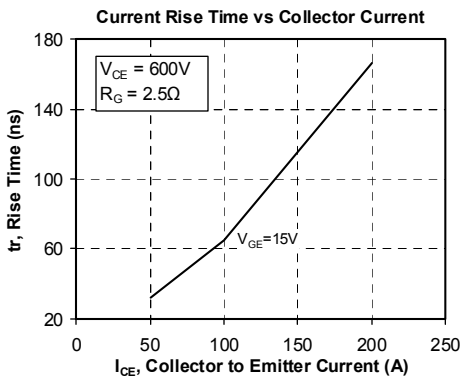
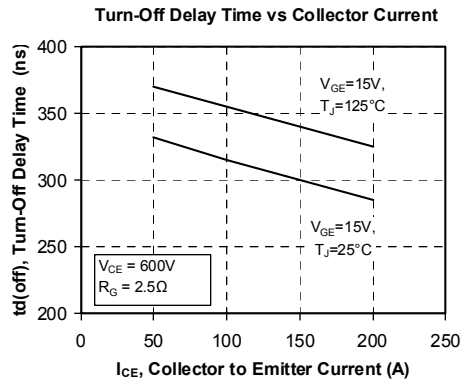
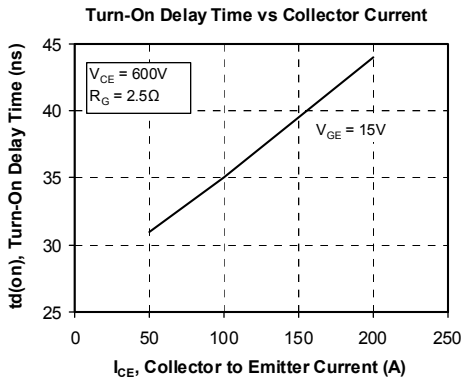

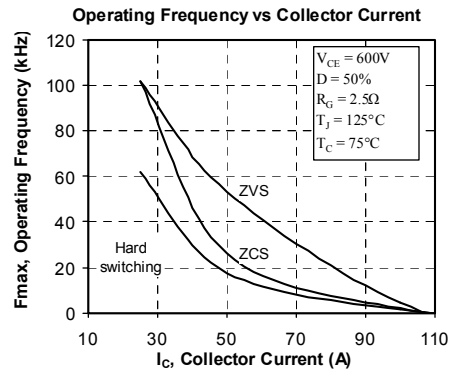
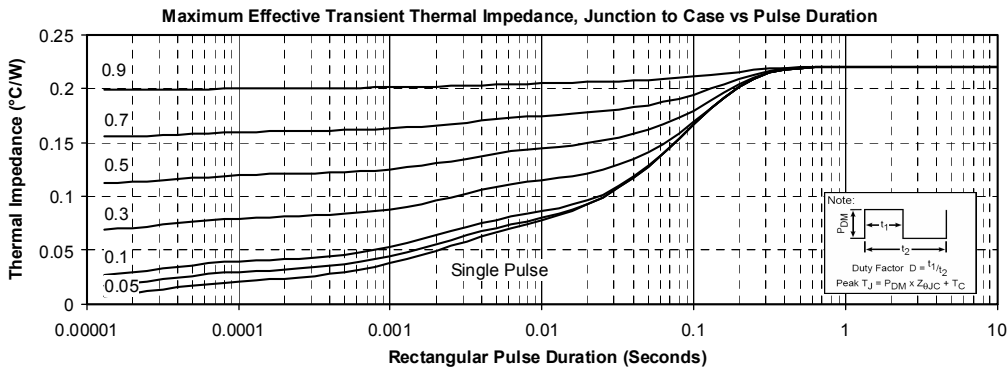
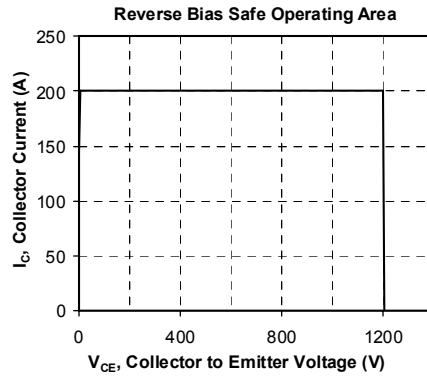
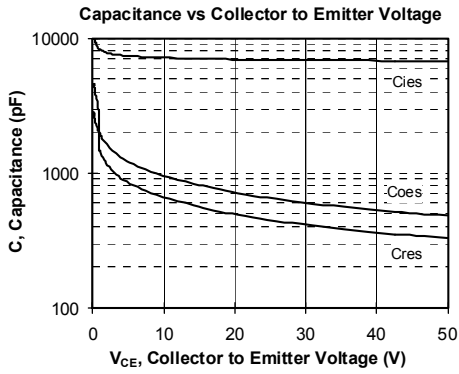

Microsemi reserves the right to change, without notice, the specifications and information contained herein

Microsemi's products are covered by one or more of U.S. patents 4,895,810 5,045,903 5,089,434 5,182,234 5,019,522 5,262,336 6,503,786 5,256,583 4,748,103 5,283,202 5,231,474 5,434,095 5,528,058 and foreign patents. U.S. and Foreign patents pending. All Rights Reserved.