

Super Junction MOSFET

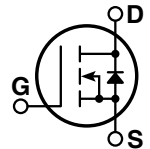

- Ultra low $R_{DS(ON)}$
- Low Miller Capacitance
- Ultra Low Gate Charge, Q_g
- Avalanche Energy Rated
- N-Channel Enhancement Mode
- Popular SOT-227 Package



MAXIMUM RATINGS

All Ratings: $T_C = 25^\circ\text{C}$ unless otherwise specified.

Symbol	Parameter	APT77N60JC3	UNIT
V_{DSS}	Drain-Source Voltage	600	Volts
I_D	Continuous Drain Current @ $T_C = 25^\circ\text{C}$	77	Amps
I_{DM}	Pulsed Drain Current ^①	231	
V_{GS}	Gate-Source Voltage Continuous	± 20	Volts
V_{GSM}	Gate-Source Voltage Transient	± 30	
P_D	Total Power Dissipation @ $T_C = 25^\circ\text{C}$	568	Watts
	Linear Derating Factor	4.55	W/ $^\circ\text{C}$
T_J, T_{STG}	Operating and Storage Junction Temperature Range	-55 to 150	$^\circ\text{C}$
T_L	Lead Temperature: 0.063" from Case for 10 Sec.	300	
dv/dt	Drain-Source Voltage slope ($V_{DS} = 480\text{V}$, $I_D = 77\text{A}$, $T_J = 125^\circ\text{C}$)	50	V/ns
I_{AR}	Repetitive Avalanche Current ^⑦	20	Amps
E_{AR}	Repetitive Avalanche Energy ^⑦	1	mJ
E_{AS}	Single Pulse Avalanche Energy ^④	1800	

STATIC ELECTRICAL CHARACTERISTICS

Symbol	Characteristic / Test Conditions	MIN	TYP	MAX	UNIT
BV_{DSS}	Drain-Source Breakdown Voltage ($V_{GS} = 0\text{V}$, $I_D = 500\mu\text{A}$)	600			Volts
$R_{DS(on)}$	Drain-Source On-State Resistance ^② ($V_{GS} = 10\text{V}$, $I_D = 60\text{A}$)		.030	0.035	Ohms
I_{DSS}	Zero Gate Voltage Drain Current ($V_{DS} = V_{DSS}$, $V_{GS} = 0\text{V}$)		1.0	50	μA
	Zero Gate Voltage Drain Current ($V_{DS} = V_{DSS}$, $V_{GS} = 0\text{V}$, $T_J = 150^\circ\text{C}$)			500	
I_{GSS}	Gate-Source Leakage Current ($V_{GS} = \pm 20\text{V}$, $V_{DS} = 0\text{V}$)			± 200	nA
$V_{GS(th)}$	Gate Threshold Voltage ($V_{DS} = V_{GS}$, $I_D = 5.4\text{mA}$)	2.1	3	3.9	Volts

 **CAUTION:** These Devices are Sensitive to Electrostatic Discharge. Proper Handling Procedures Should Be Followed.

APT Website - <http://www.advancedpower.com>

"COOLMOS™" comprise a new family of transistors developed by Infineon Technologies AG. "COOLMOS" is a trademark of Infineon Technologies AG"

DYNAMIC CHARACTERISTICS

APT77N60JC3

Symbol	Characteristic	Test Conditions	MIN	TYP	MAX	UNIT
C_{iss}	Input Capacitance	$V_{GS} = 0V$ $V_{DS} = 25V$ $f = 1\text{ MHz}$		13600		pF
C_{oss}	Output Capacitance			4400		
C_{rss}	Reverse Transfer Capacitance			290		
Q_g	Total Gate Charge ③	$V_{GS} = 10V$ $V_{DD} = 300V$ $I_D = 77A @ 25^\circ C$		505	640	nC
Q_{gs}	Gate-Source Charge			48		
Q_{gd}	Gate-Drain ("Miller") Charge			240		
$t_{d(on)}$	Turn-on Delay Time	RESISTIVE SWITCHING $V_{GS} = 10V$ $V_{DD} = 380V$ $I_D = 77A @ 125^\circ C$ $R_G = 0.9\Omega$		18		ns
t_r	Rise Time			27		
$t_{d(off)}$	Turn-off Delay Time			110	165	
t_f	Fall Time			8	12	
E_{on}	Turn-on Switching Energy ⑥	INDUCTIVE SWITCHING @ 25°C $V_{DD} = 400V, V_{GS} = 15V$ $I_D = 77A, R_G = 5\Omega$		1670		μJ
E_{off}	Turn-off Switching Energy			2880		
E_{on}	Turn-on Switching Energy ⑥	INDUCTIVE SWITCHING @ 125°C $V_{DD} = 400V, V_{GS} = 15V$ $I_D = 77A, R_G = 5\Omega$		2300		
E_{off}	Turn-off Switching Energy			3100		

SOURCE-DRAIN DIODE RATINGS AND CHARACTERISTICS

Symbol	Characteristic / Test Conditions	MIN	TYP	MAX	UNIT
I_S	Continuous Source Current (Body Diode)			77	Amps
I_{SM}	Pulsed Source Current ① (Body Diode)			231	
V_{SD}	Diode Forward Voltage ② ($V_{GS} = 0V, I_S = -77A$)		1	1.2	Volts
t_{rr}	Reverse Recovery Time ($I_S = -77A, di_S/dt = 100A/\mu s, V_R = 350V$)		861		ns
Q_{rr}	Reverse Recovery Charge ($I_S = -77A, di_S/dt = 100A/\mu s, V_R = 350V$)		46		μC
dv/dt	Peak Diode Recovery dv/dt ⑤			6	V/ns

THERMAL CHARACTERISTICS

Symbol	Characteristic	MIN	TYP	MAX	UNIT
$R_{\theta JC}$	Junction to Case			0.22	$^\circ C/W$
$R_{\theta JA}$	Junction to Ambient			40	

① Repetitive Rating: Pulse width limited by maximum junction temperature

② Pulse Test: Pulse width < 380 μs , Duty Cycle < 2%

③ See MIL-STD-750 Method 3471

④ Starting $T_J = +25^\circ C, L = 36.0mH, R_G = 25\Omega, \text{Peak } I_L = 10A$

⑤ dv/dt numbers reflect the limitations of the test circuit rather than the device itself. $I_S \leq -I_D 77A, di/dt \leq 700A/\mu s, V_R \leq V_{DSS}, T_J \leq 150^\circ C$

⑥ E_{on} includes diode reverse recovery. See figures 18, 20.

⑦ Repetitive avalanche causes additional power losses that can be calculated as $P_{AV} = E_{AR} * f$

APT Reserves the right to change, without notice, the specifications and information contained herein.

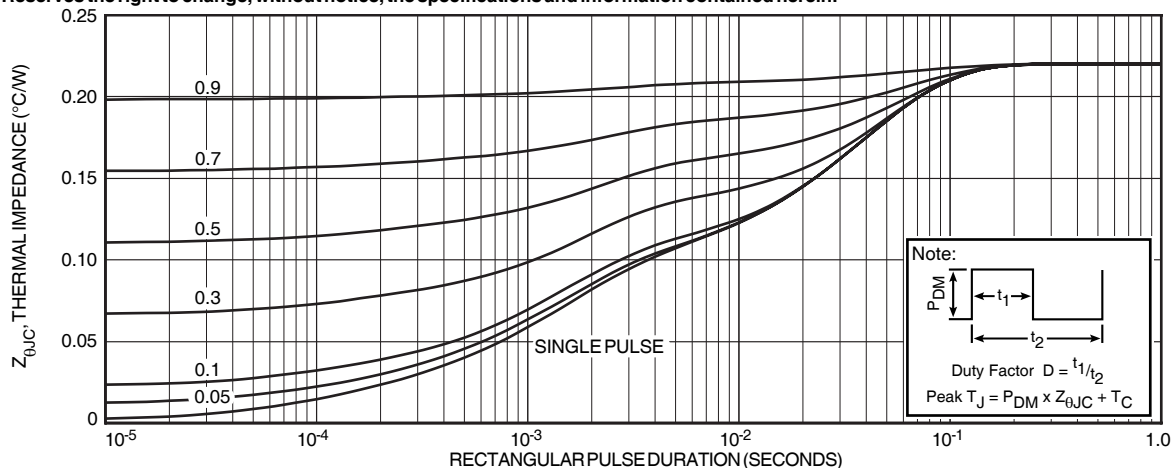

FIGURE 1, MAXIMUM EFFECTIVE TRANSIENT THERMAL IMPEDANCE, JUNCTION-TO-CASE vs PULSE DURATION

Typical Performance Curves

APT77N60JC3

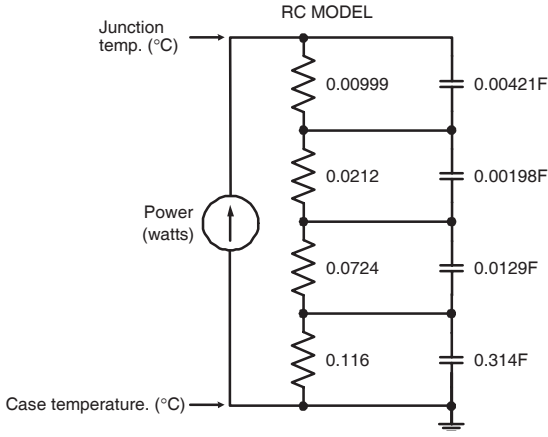

FIGURE 2, TRANSIENT THERMAL IMPEDANCE MODEL

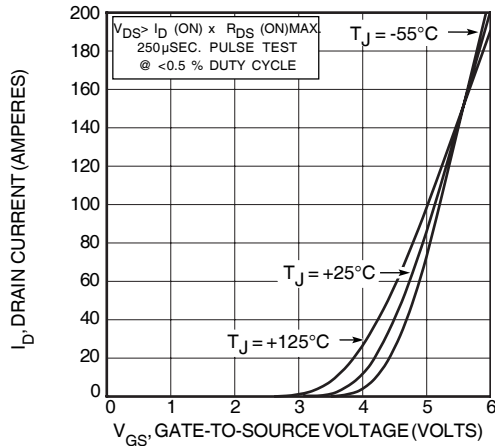

FIGURE 4, TRANSFER CHARACTERISTICS

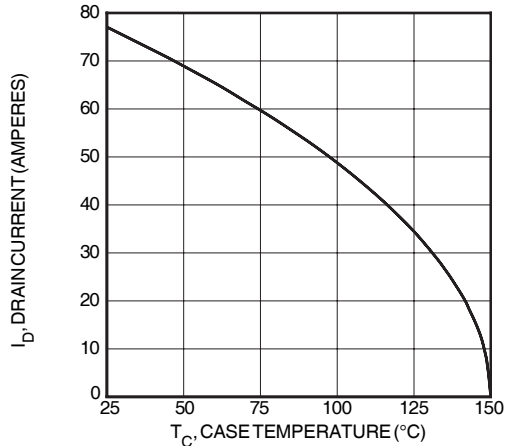

FIGURE 6, MAXIMUM DRAIN CURRENT vs CASE TEMPERATURE

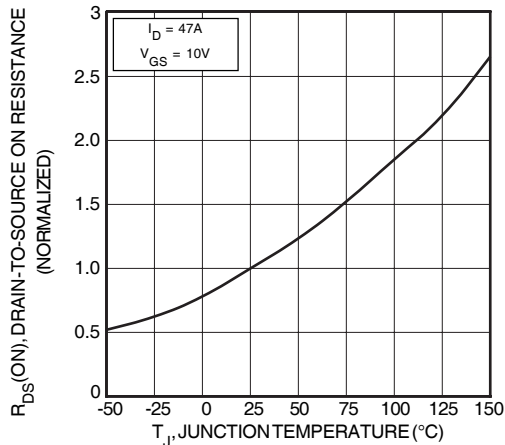

FIGURE 8, ON-RESISTANCE vs. TEMPERATURE

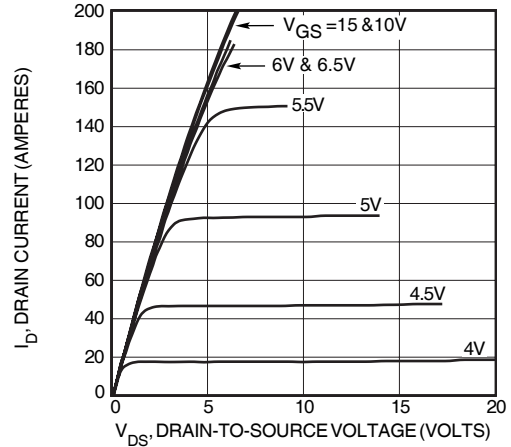

FIGURE 3, LOW VOLTAGE OUTPUT CHARACTERISTICS

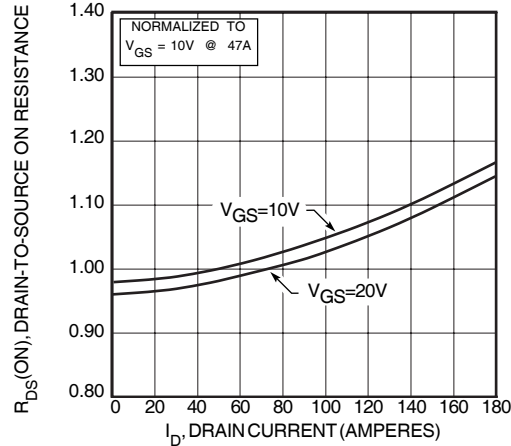

FIGURE 5, $R_{DS(ON)}$ vs DRAIN CURRENT

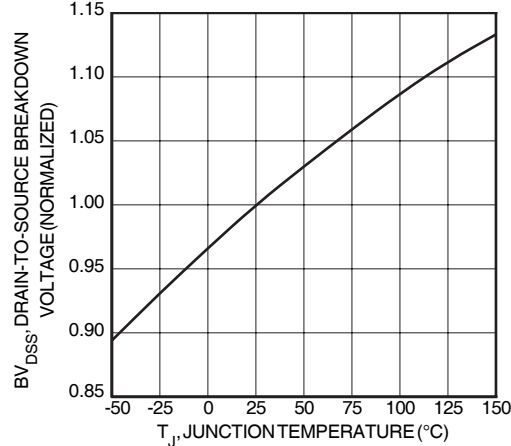

FIGURE 7, BREAKDOWN VOLTAGE vs TEMPERATURE

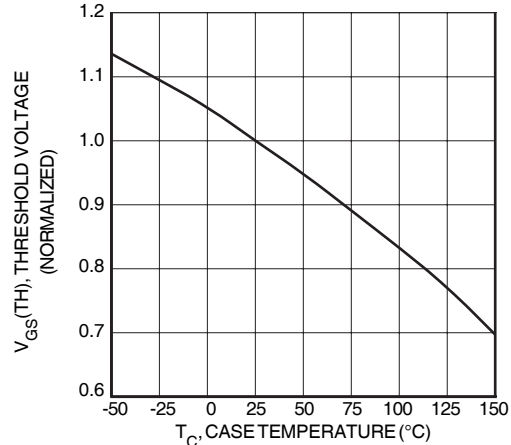

FIGURE 9, THRESHOLD VOLTAGE vs TEMPERATURE

Typical Performance Curves

APT77N60JC3

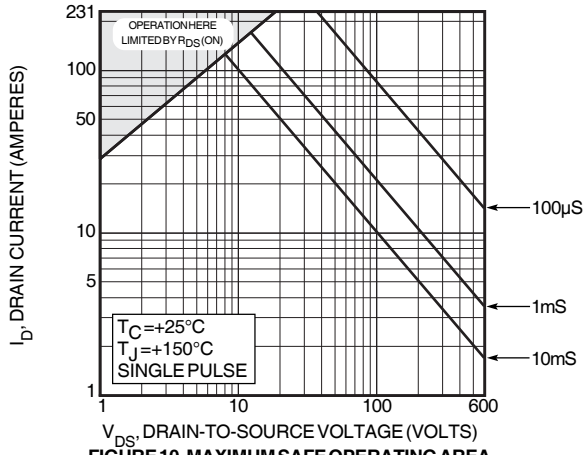

FIGURE 10, MAXIMUM SAFE OPERATING AREA

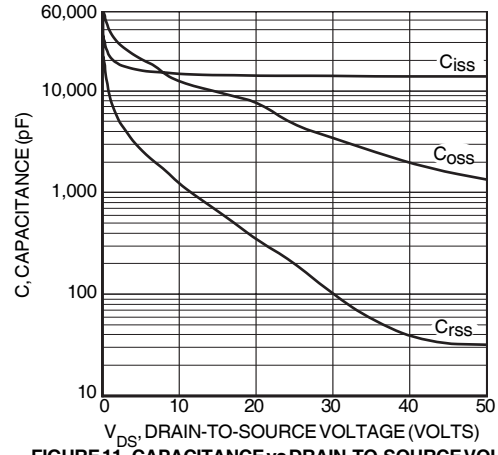

FIGURE 11, CAPACITANCE vs DRAIN-TO-SOURCE VOLTAGE

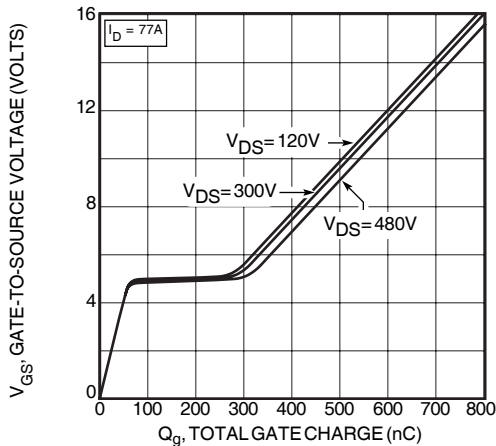

FIGURE 12, GATE CHARGES vs GATE-TO-SOURCE VOLTAGE

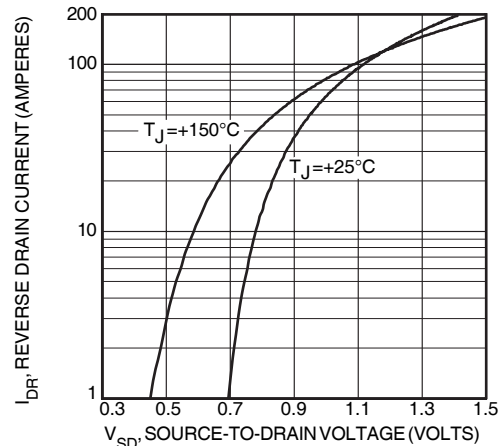

FIGURE 13, SOURCE-DRAIN DIODE FORWARD VOLTAGE

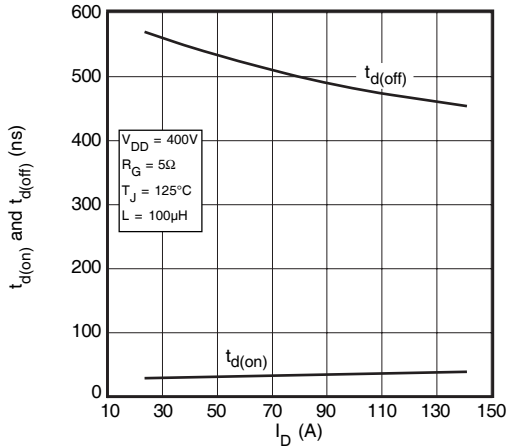

FIGURE 14, DELAY TIMES vs CURRENT

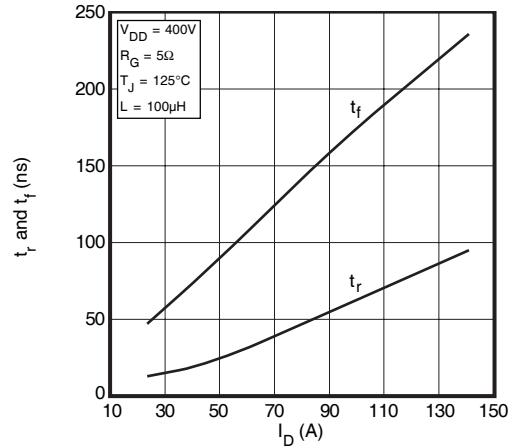

FIGURE 15, RISE AND FALL TIMES vs CURRENT

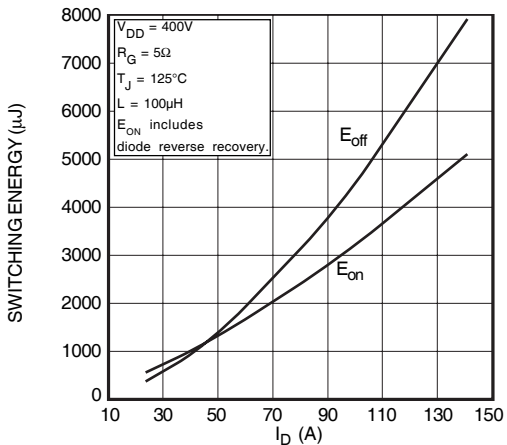

FIGURE 16, SWITCHING ENERGY vs CURRENT

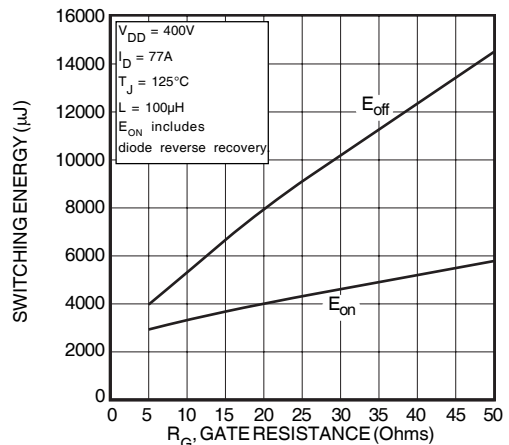

FIGURE 17, SWITCHING ENERGY vs. GATE RESISTANCE

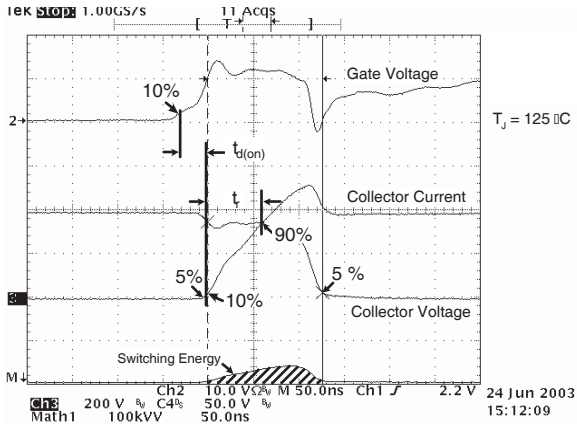

Figure 18, Turn-on Switching Waveforms and Definitions

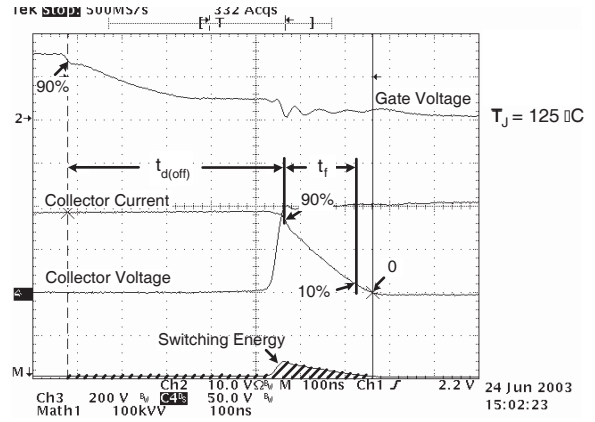

Figure 19, Turn-off Switching Waveforms and Definitions

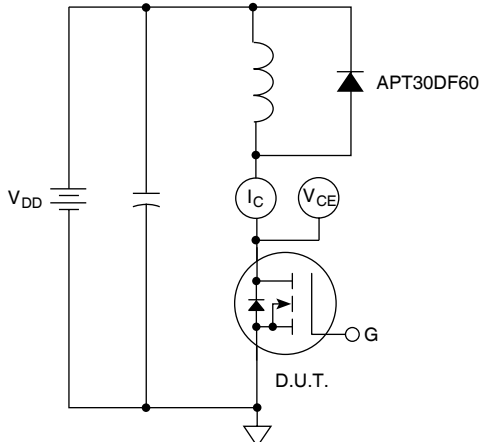
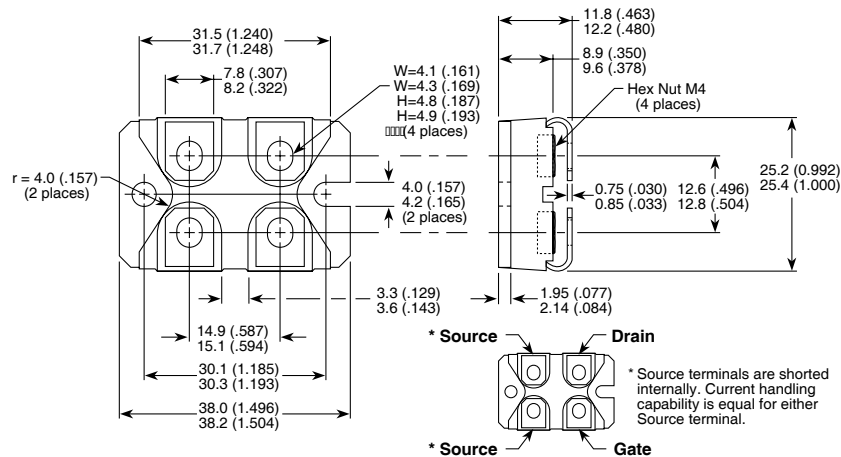

Figure 20, Inductive Switching Test Circuit

SOT-227 (ISOTOP®) Package Outline



Dimensions in Millimeters and (Inches)

ISOTOP® is a Registered Trademark of SGS Thomson. APT's products are covered by one or more of U.S. patents 4,895,810 5,045,903 5,089,434 5,182,234 5,019,522 5,262,336 6,503,786 5,256,583 4,748,103 5,283,202 5,231,474 5,434,095 5,528,058 and foreign patents. US and Foreign patents pending. All Rights Reserved.