

Part Number: APHK1608SEC

SUPER BRIGHT ORANGE

Features

- 1.6mmx0.8mm SMT LED, 0.7mm THICKNESS.
- LOW POWER CONSUMPTION.
- WIDE VIEWING ANGLE.
- IDEAL FOR BACK LIGHT AND INDICATOR.
- VARIOUS COLORS AND LENS TYPES AVAILABLE.
- MOISTURE SENSITIVITY LEVEL : LEVEL 4.
- PACKAGE : 2000PCS / REEL.
- RoHS COMPLIANT.

Description

The Super Bright Orange device is made with DH InGaAlP (on GaAs substrate) light emitting diode chip.

Package Dimensions

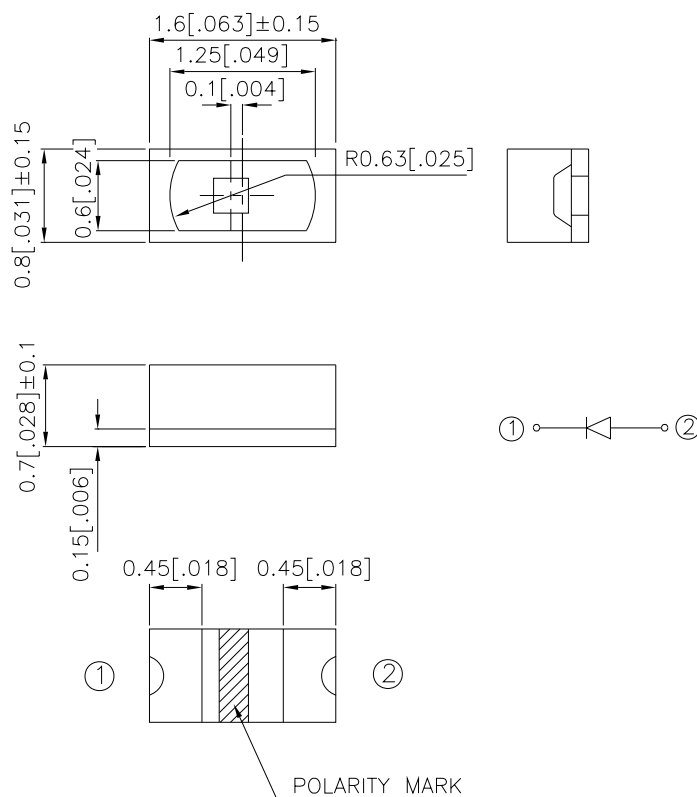

Notes:

1. All dimensions are in millimeters (inches).
2. Tolerance is ± 0.1 (0.004") unless otherwise noted.
3. Specifications are subject to change without notice.

Selection Guide

Part No.	Dice	Lens Type	Iv (mcd) [2] @ 20mA		Viewing Angle [1]
			Min.	Typ.	2 θ 1/2
APHK1608SEC	SUPER BRIGHT ORANGE (InGaAlP)	WATER CLEAR	110	280	90°

Notes:

1. θ 1/2 is the angle from optical centerline where the luminous intensity is 1/2 the optical centerline value.
2. Luminous intensity/ luminous Flux: +/-15%.

Electrical / Optical Characteristics at TA=25°C

Symbol	Parameter	Device	Typ.	Max.	Units	Test Conditions
λ_{peak}	Peak Wavelength	Super Bright Orange	610		nm	IF=20mA
λ_D [1]	Dominant Wavelength	Super Bright Orange	601		nm	IF=20mA
$\Delta\lambda_{1/2}$	Spectral Line Half-width	Super Bright Orange	29		nm	IF=20mA
C	Capacitance	Super Bright Orange	30		pF	VF=0V;f=1MHz
VF [2]	Forward Voltage	Super Bright Orange	2.0	2.5	V	IF=20mA
IR	Reverse Current	Super Bright Orange		10	uA	VR= 5V

Notes:

1. Wavelength: +/-1nm.
2. Forward Voltage: +/-0.1V.

Absolute Maximum Ratings at TA=25°C

Parameter	Super Bright Orange	Units
Power dissipation	75	mW
DC Forward Current	30	mA
Peak Forward Current [1]	195	mA
Reverse Voltage	5	V
Operating / Storage Temperature	-40°C To +85°C	

Note:

1. 1/10 Duty Cycle, 0.1ms Pulse Width.

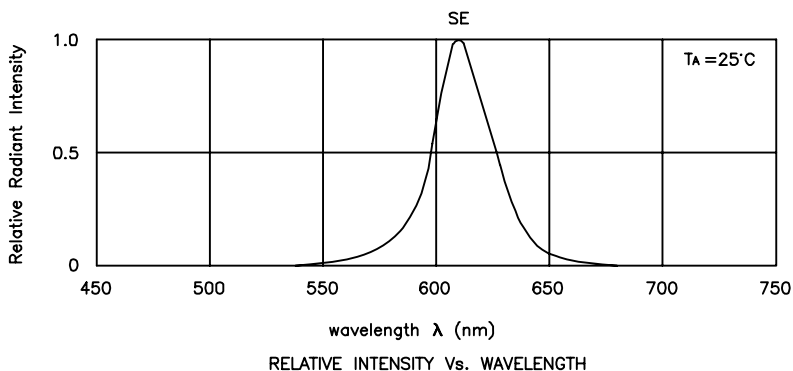

Super Bright Orange

APHK1608SEC

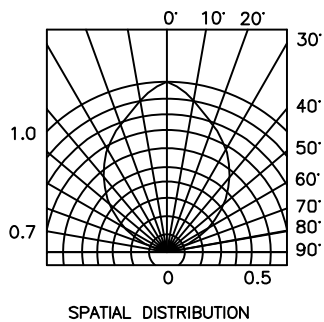
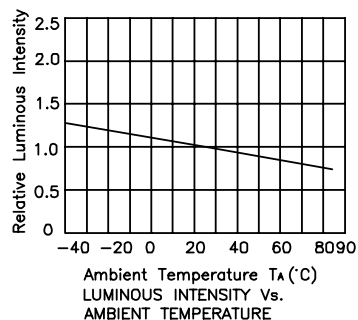
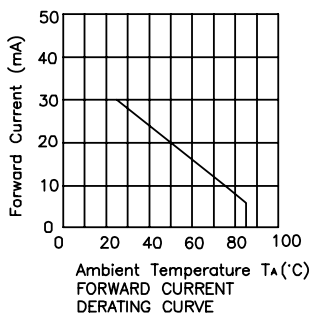
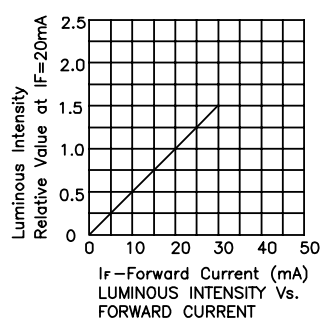
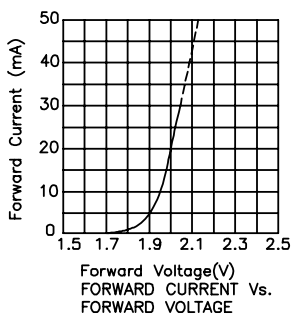

APHK1608SEC

Reflow Soldering Profile For Lead-free SMT Process.

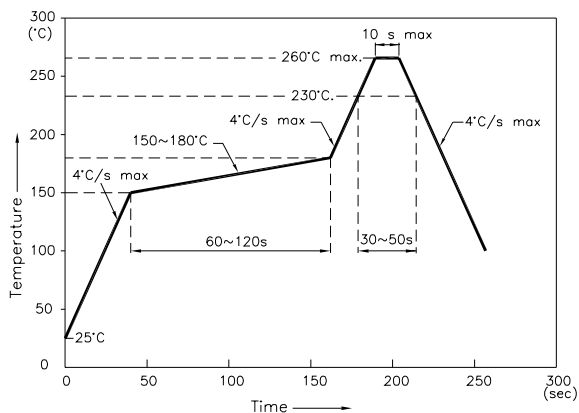

NOTES:

1. We recommend the reflow temperature 245°C(+/-5°C). The maximum soldering temperature should be limited to 260°C.
2. Don't cause stress to the epoxy resin while it is exposed to high temperature.
3. Number of reflow process shall be 2 times or less.

Recommended Soldering Pattern (Units: mm ; Tolerance: ± 0.1)

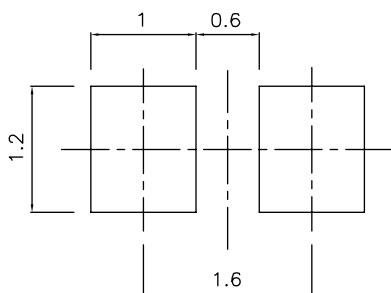

Tape Specifications (Units : mm)

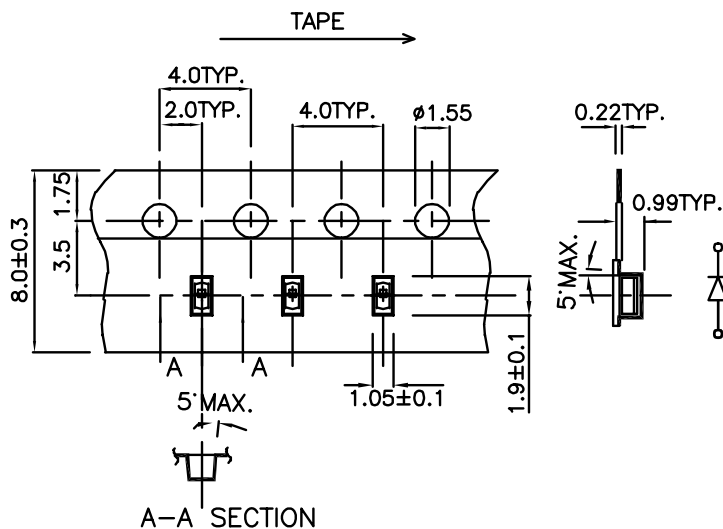

PACKING & LABEL SPECIFICATIONS

APHK1608SEC

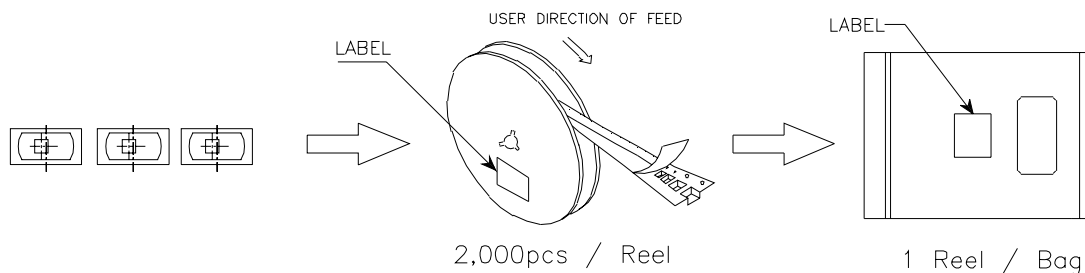

60K / 20# BOX

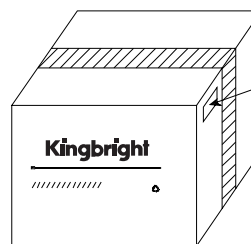

30K / 55# Box

Kingbright	
P/NO: APHK1608XXX	
QTY: 2,000 pcs	Q.C. Q C xx xx.xxxx PASSED
S/N: XXXX	Date
CODE: XXX	
LOT NO:	
	
xxxxxxxxxxxxxxxxxxxxxxxxxxxxxxxx	
RoHS Compliant	