

PRELIMINARY SPEC

Part Number: APED3528VGC/A-F01      Green



**ATTENTION**  
OBSERVE PRECAUTIONS  
FOR HANDLING  
ELECTROSTATIC  
DISCHARGE  
SENSITIVE  
DEVICES

**Features**

- SINGLE COLOR.
- SUITABLE FOR ALL SMT ASSEMBLY AND SOLDER PROCESS.
- IDEAL FOR BACKLIGHTING.
- AVAILABLE ON TAPE AND REEL.
- PACKAGE: 500PCS / REEL.
- MOISTURE SENSITIVITY LEVEL : LEVEL 3.
- RoHS COMPLIANT.

**Description**

The Green source color devices are made with InGaN on G-SiC Light Emitting Diode. Static electricity and surge damage the LEDs. It is recommended to use a wrist band or anti-electrostatic glove when handling the LEDs. All devices, equipment and machinery must be electrically grounded.

**Package Dimensions**

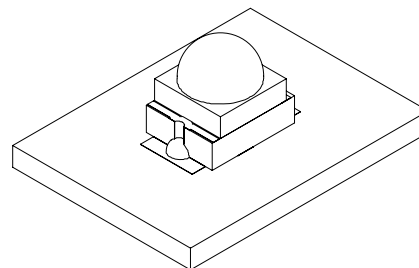
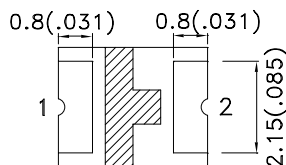
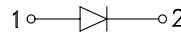
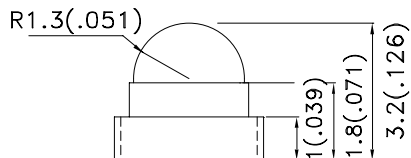
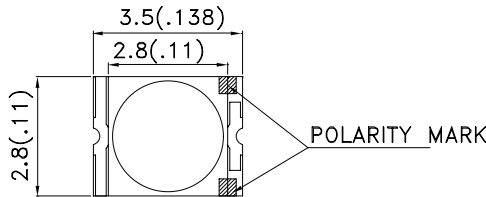

Notes:

1. All dimensions are in millimeters (inches).
2. Tolerance is  $\pm 0.2(0.008)$  unless otherwise noted.
3. Specifications are subject to change without notice.
4. The device has a single mounting surface. The device must be mounted according to the specifications.



## Selection Guide

Part No.	Dice	Lens Type	Iv (mcd) [2] @ 20mA		Viewing Angle [1]
			Min.	Typ.	2θ1/2
APED3528VGC/A-F01	Green (InGaN)	WATER CLEAR	110	300	40°

Notes:

1. θ1/2 is the angle from optical centerline where the luminous intensity is 1/2 the optical centerline value.
2. Luminous intensity/ luminous Flux: +/-15%.

## Electrical / Optical Characteristics at TA=25°C

Symbol	Parameter	Device	Typ.	Max.	Units	Test Conditions
λ <sub>peak</sub>	Peak Wavelength	Green	520		nm	I <sub>F</sub> =20mA
λ <sub>D</sub> [1]	Dominant Wavelength	Green	525		nm	I <sub>F</sub> =20mA
Δλ <sub>1/2</sub>	Spectral Line Half-width	Green	35		nm	I <sub>F</sub> =20mA
C	Capacitance	Green	100		pF	V <sub>F</sub> =0V;f=1MHz
V <sub>F</sub> [2]	Forward Voltage	Green	3.2	4	V	I <sub>F</sub> =20mA
I <sub>R</sub>	Reverse Current	Green		10	uA	V <sub>R</sub> =5V

Notes:

1. Wavelength: +/-1nm.
2. Forward Voltage: +/-0.1V.

## Absolute Maximum Ratings at TA=25°C

Parameter	Green	Units
Power dissipation	120	mW
DC Forward Current	30	mA
Peak Forward Current [1]	100	mA
Reverse Voltage	5	V
Operating Temperature	-40°C To +85°C	
Storage Temperature	-40°C To +85°C	

Note:

1. 1/10 Duty Cycle, 0.1ms Pulse Width.

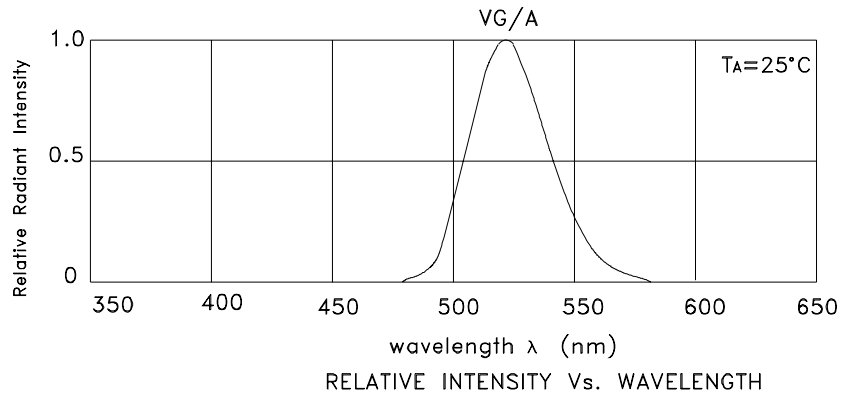

Green

APED3528VGC/A-F01

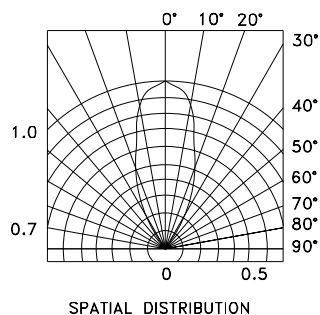
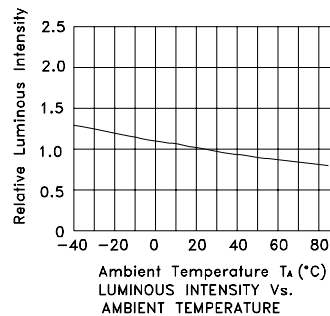
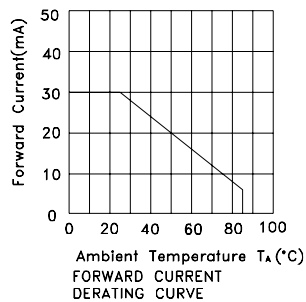
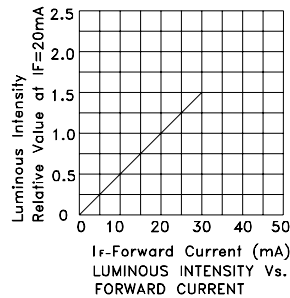
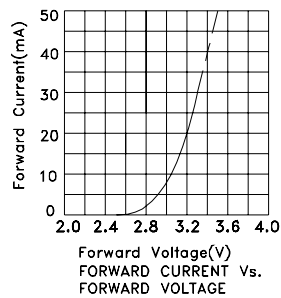

## APED3528VGC/A-F01

Reflow Soldering Profile For Lead-free SMT Process.



NOTES:

1. We recommend the reflow temperature 245°C(+/-5°C). The maximum soldering temperature should be limited to 260°C.
2. Don't cause stress to the epoxy resin while it is exposed to high temperature.
3. Number of reflow process shall be 2 times or less.

### Recommended Soldering Pattern (Units : mm; Tolerance: ± 0.1)

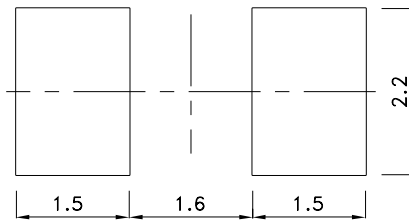

### Tape Specifications (Units : mm)

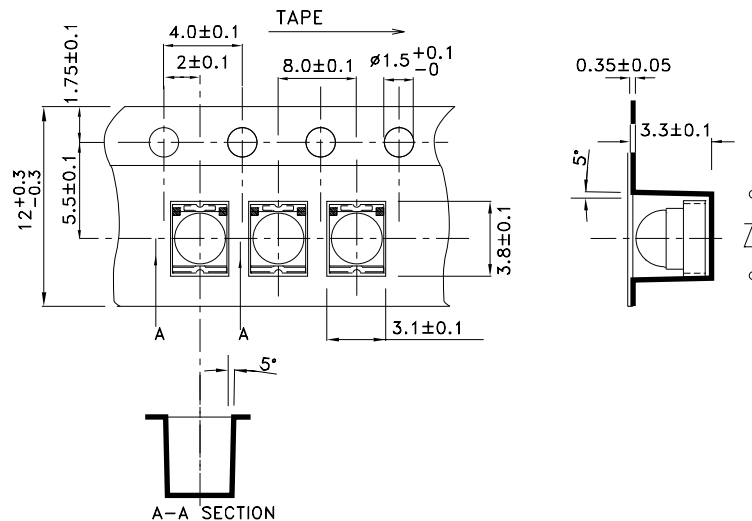

# Kingbright

## PACKING & LABEL SPECIFICATIONS

## APED3528VGC/A-F01

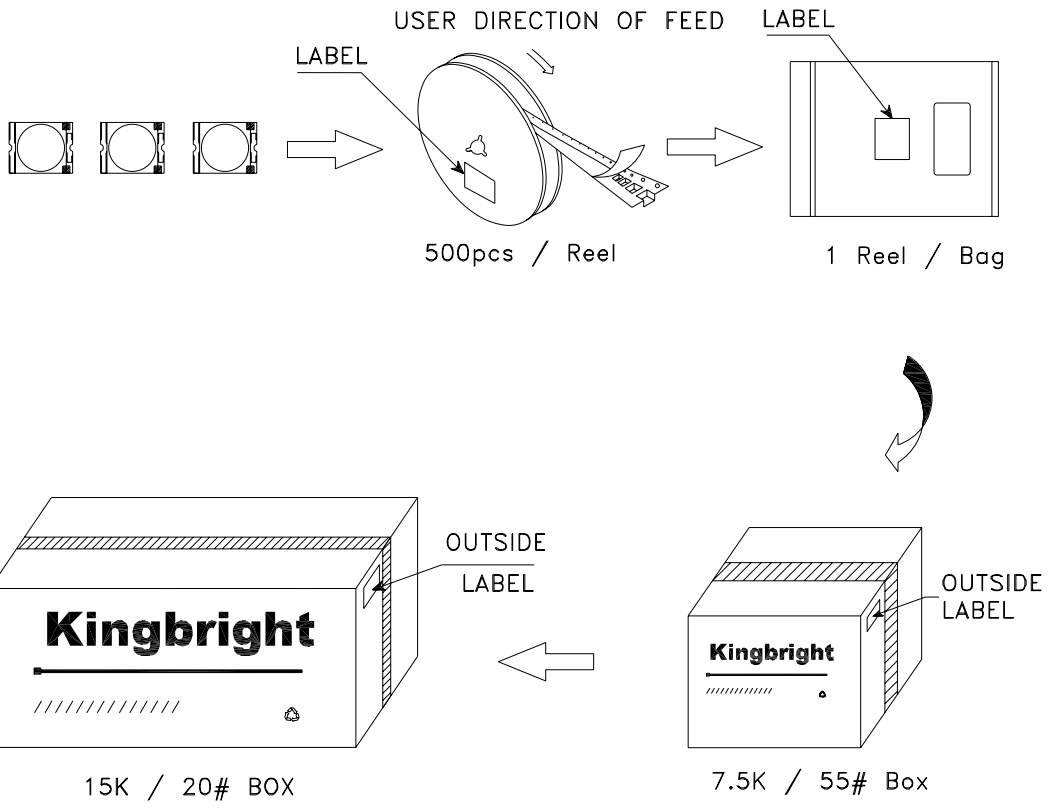

<b>Kingbright</b>	
P/NO: APED3528xxx	
QTY: 500 pcs	Q.C. <span style="border: 1px solid black; border-radius: 50%; padding: 2px;">Q C xx xx xxxx PASSED</span>
S/N: XXXX	
CODE: XXX	
LOT NO:	
 xxxxxxxxxxxxxxxxxxxxxxxxxxxxxxxxxxxx	
MADE IN CHINA	RoHS Compliant