

1.0 General Description

The AMIS-70020 is a timer IC that measures the duration of power failures of up to five hours. The AMIS-70020 starts and stops counting automatically as it is triggered by the voltage of the input signal VCC. When VCC gets lower than the reference signal VDD - VTH, a power cut-off is flagged and the AMIS-70020 starts counting. During the counting phase the AMIS-70020 is powered by an external capacitor or by a primary battery and consequently operates independently of an external power supply. Due to the low power design of the AMIS-70020, the device can count the full scale autonomously using the energy stored in a 10mF capacitor.

As soon as VCC comes up again counting stops. The value of the counter is shifted to the digital Q_OUT output pin and is communicated to a microprocessor. After shifting the full counted value, the internal RC-oscillator signal is put on the Q_OUT output pin. Using this data the microcontroller can calculate the duration of the power failure.

The internal power management circuit manages the recharge of the external buffer capacitor.

The few external components required to build the AMIS-70020 into its application result in a cost effective solution and in a footprint of less than 2cm². The combination of an internal oscillator and a microcontroller software algorithm eliminate the requirement for a space and cost consuming external crystal.

Typical applications are those sensitive to power failures that do not have a built-in UPS function. Examples are:

- Power inverters/Motordrivers/Soft starters
 - Accurate I²t protection possible even after power loss
 - Thermal protection devices for electrical motors without integrated thermistor
 - Motor controllers for electrical motors without integrated thermistor
- Process control
 - Chemical processes
 - Industrial mixers
 - Mixing reactors

2.0 Key Features

- Measures the time elapsed during a power failure
 - Measures up to five hours
 - 1 second resolution (RC oscillator/1024)
- Autonomous operation during power failure
 - Auto switching to backup power
- Auto counter-start/stop function
 - Maintenance free buffer capacitor
 - 6 hours back-up with 10mF
 - Capacitor recharge management built in (no external diode needed)
 - Li-button cell
 - CR1220 (35mAh) supports up to 10 years in a typical application
- Low current consumption <1µA
- Built-in 1kHz oscillator
 - No external oscillator required
 - Frequency of oscillator can be read by an external microcontroller
 - Accurate time measurement possible using software calibration algorithm
- 2-wire interface with standard I/O pins of a microcontroller
- Operating temperature -10~85°C
- 150 mils SO8 package
- Few external components
- Easy design-in due to a user friendly application board

3.0 Ordering Information

| | |
|---------------|-----------------------|
| Ordering Code | AMIS-70020 |
| Package | SO8 |
| Temp. Range | -10°C...-85°C |
| Ordering Code | EVK-70020 |
| | Evaluation kit |

For sample requests contact your local sales representative at www.amis.com/sales.

4.0 Block Diagram

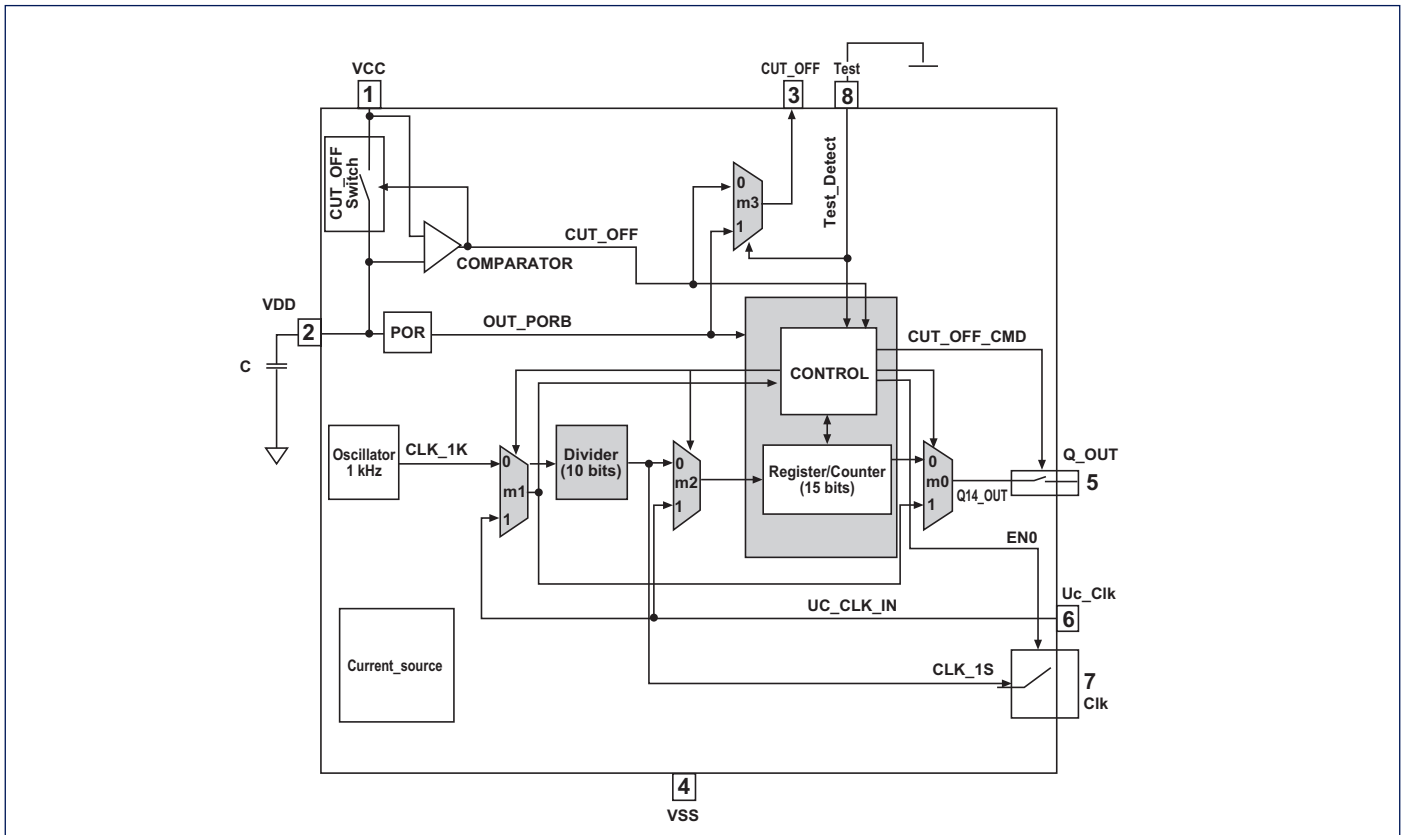

5.0 Packaging

The AMIS-70020 is packaged in a 150mils SO8. Please visit <http://www.amis.com/pdf/soic.pdf> for detailed mechanical information.

Pinout

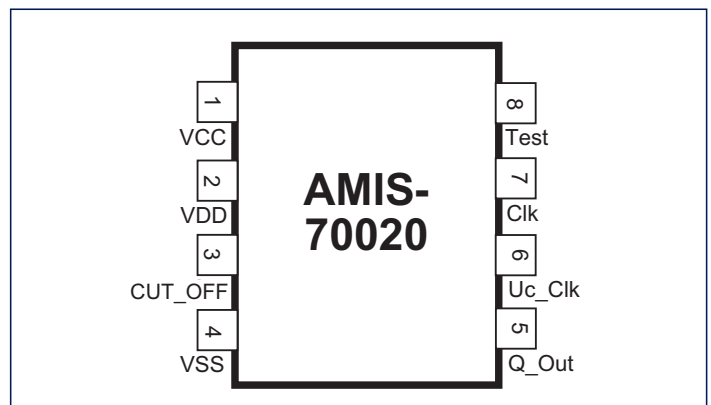

Pad Description

| Pad No. | Name | Type | Comment |
|---------|---------|----------------|---|
| 1 | VCC | Power | System power that is monitored |
| 2 | VDD | Power | Back-up power |
| 3 | CUT_OFF | Digital Output | Not connected, test purpose only |
| 4 | VSS | Power | Ground |
| 5 | Q_OUT | Digital Output | Shift register output (CMOS output buffer 2mA) |
| 6 | Uc_Clk | Digital Input | CLK from microcontroller (Schmitt trigger input); an internal pull down (100KΩ) is connected on the pin |
| 7 | Clk | Digital Output | Internal oscillator/1024 (1Hz) (CMOS output buffer 2mA) |
| 8 | Test | Digital Input | For normal operation: connect to GND |

6.0 Application Diagram

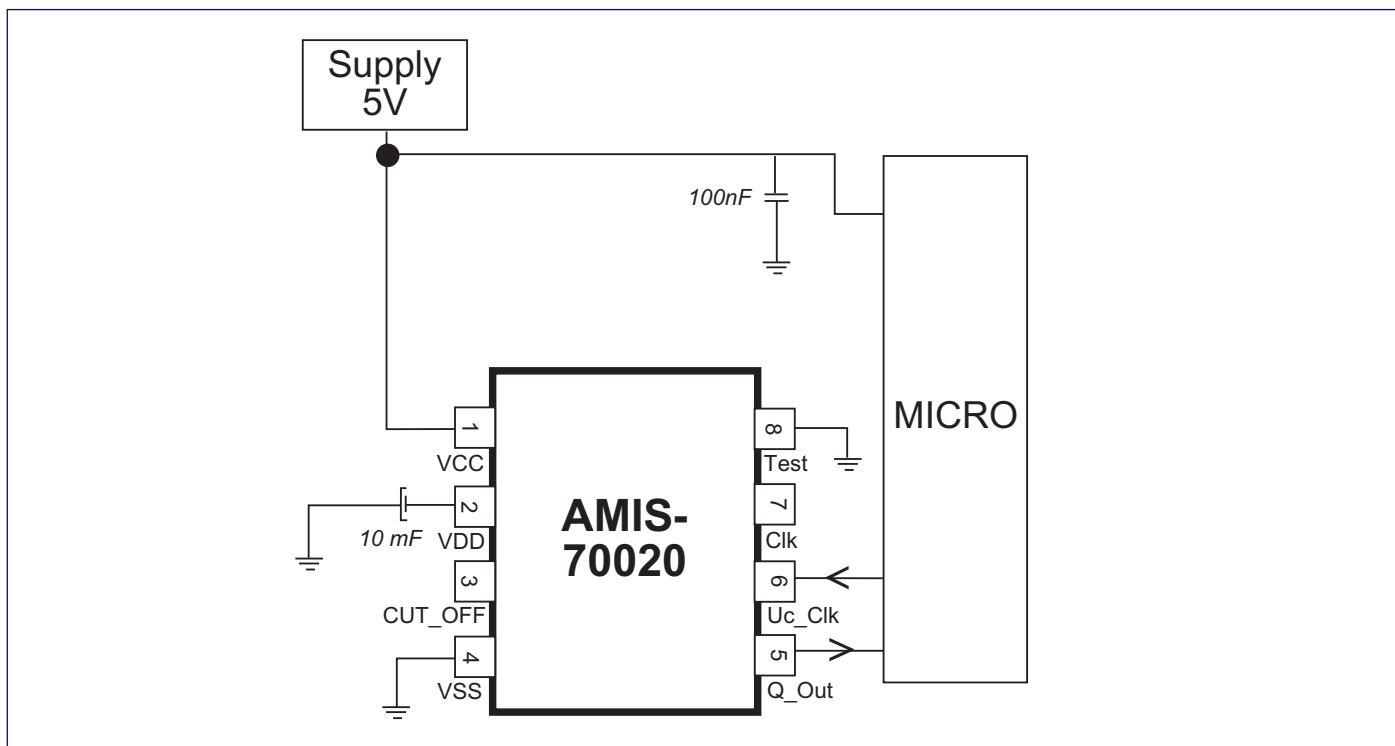

The power supplies of the chip need to be properly decoupled. This means that at least one external capacitor CDD must be connected in between VSS and VCC.

Typical External Components

| Component | Function | Typical Value | Tol | Unit |
|-----------------|---------------------|----------------|---------|------|
| Capacitor | Filter | 100 | +/- 20% | nF |
| Capacitor 1 | Backup power supply | 10 | +/- 10% | mF |
| Li Battery 1, 2 | Backup power supply | CR1220 (35mAh) | | |

- 1) Either a buffer capacitor or a Li-battery is selected as a backup power supply.
- 2) In case a Li-battery is used as a backup power supply a diode is must be placed between the AMIS-70020 and the battery to disable the charging feature.

7.0 Electrical and Environmental Ratings

Operating Ranges

This section defines the limits for functional operation and parametric characteristics of the device as described elsewhere in this document. Note that functionality of the IC outside the operating ranges is not guaranteed.

Operation outside the operating ranges for extended periods may affect device reliability. Total cumulative dwell time above the maximum operating rating for power supply or temperature must be less than 100 hours.

| Symbol | Description | Min | Max | Unit |
|-----------------|--------------------------------|---------|--------|------|
| VCC | Power supply voltage | 4.5 | 5.5 | V |
| VDD | Power supply voltage | 2 | 5.5 | V |
| Tamb | Ambient temperature under bias | -10 | 85 | °C |
| Tj | Junction temperature | | 135 | °C |
| Cl _a | Load capacitance on outputs | | 70 | pF |
| V _{IH} | Digital input levels | 70% VDD | | V |
| V _{IL} | Digital input levels | | 30%VDD | V |
| V _{OH} | Digital output levels | 2.5 | | V |
| V _{OL} | Digital output levels | | 0.4 | V |

Input operating range of digital IO's 0-VDD
Output operating range of digital IO's 0-VDD

Absolute Maximum Ratings

Stresses above those listed in this clause may cause immediate and permanent device failure. It is not implied that more than one of these conditions can be applied simultaneously.

| Symbol | Description | Min | Max | Unit |
|---------|--------------------------------|-----------|-----|------|
| VCC | Power supply voltage | -0.3 | 7 | V |
| VDDmr | Power supply voltage | -0.3 | 7 | V |
| Tamb,mr | Ambient temperature under bias | -10 | 85 | °C |
| Tj,mr | Junction temperature | | 150 | °C |
| VIH | Digital input levels | VDD + 0.3 | | V |
| VIL | | VDD - 0.3 | | V |

Electrical Overstress Immunity

Electrostatic discharges on component level:

- (1) The device withstands 2000V Human Body Model ESD pulses when tested according to MIL STD 883 method 3015.5 (pin combination 2).

Latch-up immunity:

- (2) Static latch-up protection level is 100mA at 25°C when tested according to EIA/JESD78.

8.0 Detailed Electrical and Functional Description

Digital Interface

The digital interface with a microcontroller can be made by means of only two digital connections. The first is the clock signal to be applied to the AMIS-70020 UC_CLK pin and the second is the data line to be read by the microcontroller from the Q_OUT pin. After a POR or after a power failure (CUT_OFF) the 15 bit shift register is loaded with the counter value and connected to the Q_OUT pin. The most significant bit, MSB is already present and can be read at the Q_OUT pin. Applying clocks at a maximum rate of 10MHz on UC_CLK will shift out the remaining counter bits. After the fifteenth clock, the internal oscillator frequency will be connected to the Q_OUT pin as a running clock signal. By measuring the period of this signal, the time a cut-off was present can be calculated by the microcontroller.

An internal pull down resistor is connected to the pin Q_OUT, in order to avoid the parasitic shift of the counting register.

If VCC is powered up, a third optional pin – CLK - gives the counter clock signal of about 1Hz. This clock is the internal oscillator, divided by 1024 and can also be used to calibrate the application.

Connections made with the microcontroller are separated by level shifters. When in power failure mode, the inputs of the AMIS-70020 are fixed to zero state. This will prevent unwanted current leaking.

Timing Diagram

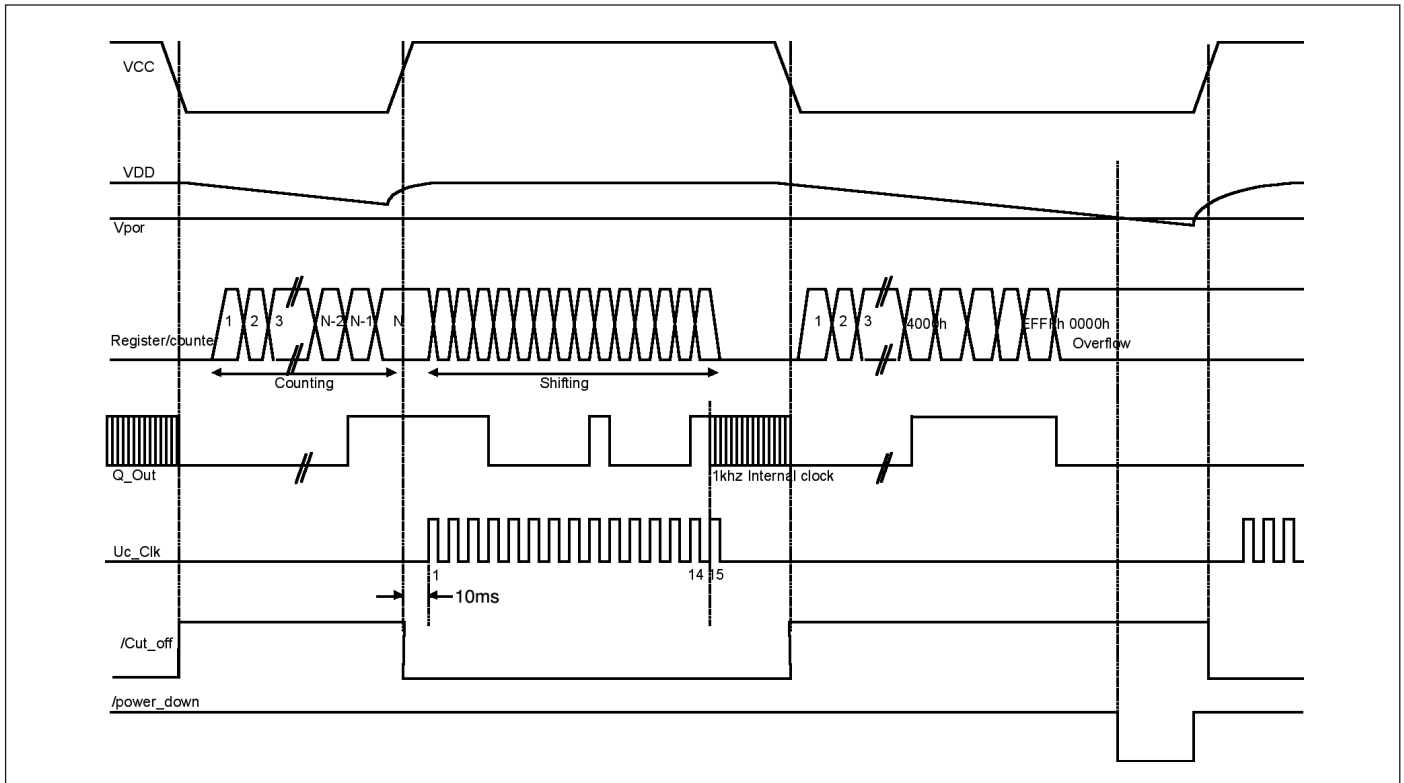

Flowchart

The flowchart depicts the operation of the AMIS-70020 in case VCC gets smaller than VDD-VTH. After this flow has been finished the buffer capacitor is recharged and the timer IC is ready for a new cycle.

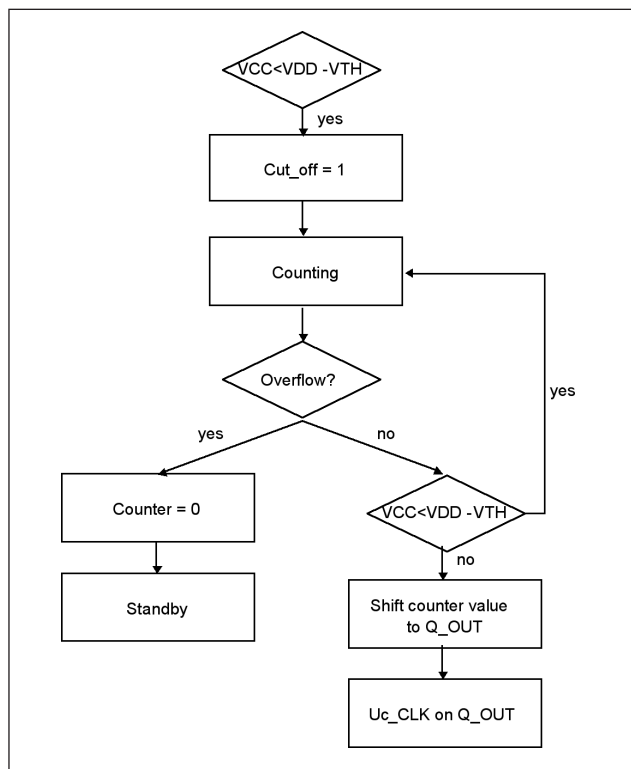

Description of the Main Building Blocks

Oscillator

The AMIS-70020 integrates an oscillator that functions without any external components. The maximum accuracy of the time measurement can only be obtained if the measured time is calibrated with the actual oscillator

frequency. This can be done since the oscillator output frequency can be measured by the microcontroller on the Q_out pin after the measured counter value has been shifted out the register.

| Symbol | Description | Min | Typ | Max | Unit |
|--------|-------------------------------|-----|-----|-----|------|
| Fosc | Absolute frequency at ambient | 0.5 | 0.9 | 1.9 | kHz |

Comparator

When $VCC < VDD - VTH$, the comparator output (CUT_OFF) is commuted. CUT_OFF signal is used by the digital control to put the circuit in cut_off mode.

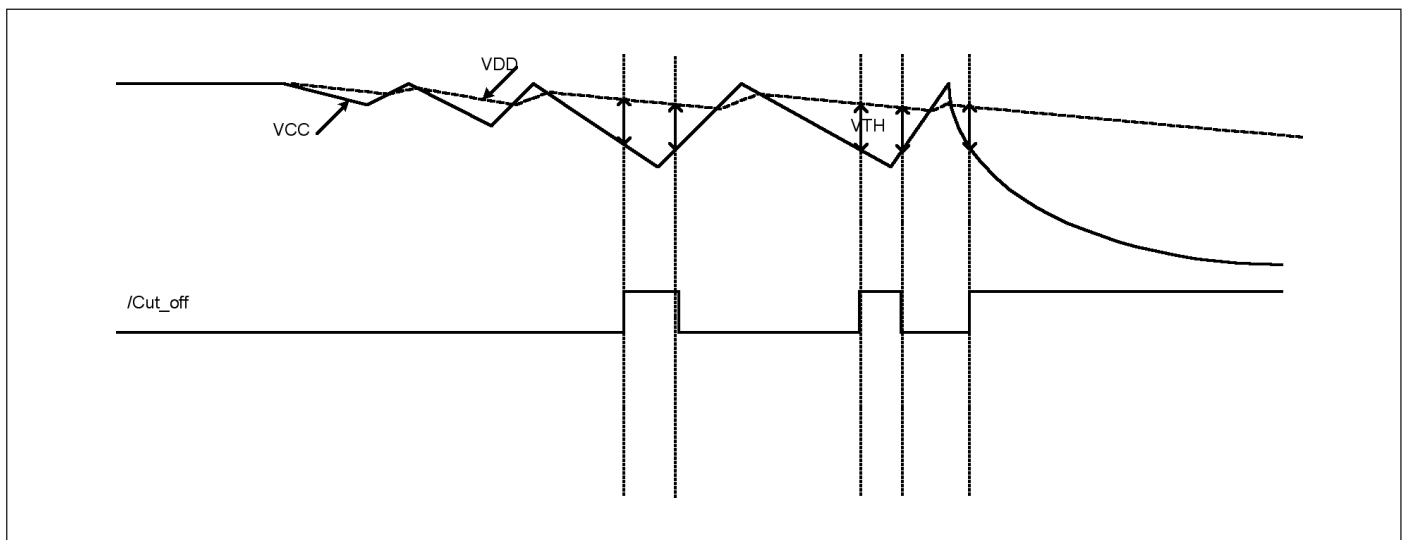

| Symbol | Description | Min | Typ | Max | Unit |
|--------|-------------------|------|-----|------|------|
| VTH | VDD-VCC threshold | 0.75 | 1.4 | 1.75 | V |

Power on Reset

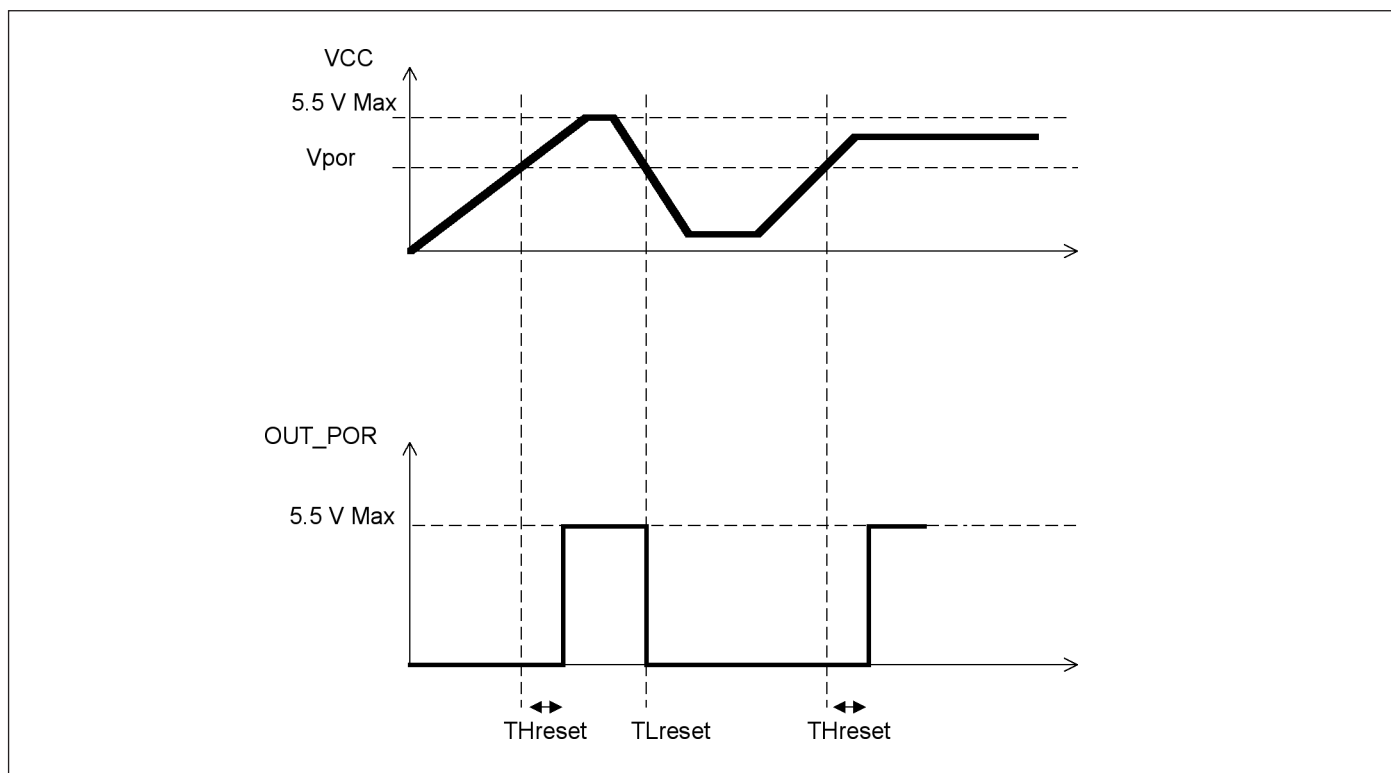

| Symbol | Min | Typ | Max | Unit |
|---------|--------------------|------|------|------|
| Vpor | 1.65 | 2.25 | 3.08 | V |
| THreset | Value not testable | | | |
| TLreset | Value not testable | | | |

Cut_off Switch

It is controlled by cut_off_ctrl when the comparator and filter have detected the loss of VCC, in this case the switch is OFF.

| Symbol | Description | Min | Typ | Max | Unit |
|--------|-----------------------------|-----|-----|-----|----------|
| Ron | Resistance ON of the switch | 250 | | 500 | Ω |

Current Consumption

| Symbol | Description | Min | Typ | Max | Unit |
|--------|--|-----|-----|-----|---------------|
| IDD | DC current in cut_off mode No load at the pin Test_OUT, Q_OUT | 0.1 | 0.5 | 1 | μA |

| Revision Number | Changes on page |
|-----------------|-----------------|
| Version 1.1 | |