

**FEATURES**

**Fixed gain of 20 dB**  
**Operation up to 1000 MHz**  
**+37.3 dBm OIP3 at 70 MHz**  
**Noise Figure 2.9 dB at 70 MHz**  
**Input/output internally matched to 75  $\Omega$**   
**Temperature and power supply stable**  
**Power supply: 5 V**  
**Power supply current: 66 mA**  
**1000 V ESD (Class 1C)**

**FUNCTIONAL BLOCK DIAGRAM**

Figure 1. Block Diagram

**GENERAL DESCRIPTION**

The ADL5533 is a fixed-gain, linear amplifier that operates at frequencies up to 1000 MHz. Intended for use in a wide variety of applications, including broadband, CATV, cable modem and FTTH.

The fixed gain of 20 dB is stable over frequency, temperature, power supply and from device to device. OIP3 is +37.3 dBm with an output compression point of +18.8 dBm and a noise figure of 2.9 dB.

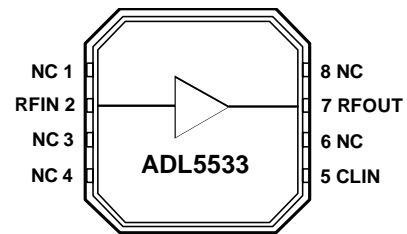
The ADL5533 is single-ended and internally matched to 75  $\Omega$  with an input return loss of 10 dB. Only input/output ac-

coupling capacitors, a power supply decoupling capacitor and external inductor are required for operation.

This amplifier operates with a supply voltage of +5V, consuming 66 mA of supply current.

The ADL5533, fabricated on a GaAs HBT process, and has an ESD rating of 1000 V (Class 1C). The device is packaged in a 3mm x 3mm LFCSP that uses an exposed paddle for excellent thermal impedance and operates from -40°C to +85°C. A fully populated evaluation board is available.

**Rev. PrC 5/07**

Information furnished by Analog Devices is believed to be accurate and reliable. However, no responsibility is assumed by Analog Devices for its use, nor for any infringements of patents or other rights of third parties that may result from its use. Specifications subject to change without notice. No license is granted by implication or otherwise under any patent or patent rights of Analog Devices. Trademarks and registered trademarks are the property of their respective owners.

**TABLE OF CONTENTS**

Features .....	1	ESD Caution.....	4
Functional Block Diagram .....	1	Pin Configuration and Function Descriptions.....	5
General Description .....	1	Typical Performance Characteristics .....	6
Revision History .....	2	Evaluation Board .....	7
Specifications.....	3	Outline Dimensions .....	9
Absolute Maximum Ratings.....	4	Ordering Guide .....	9

**REVISION HISTORY**

5/07—Rev. PrC: Preliminary Version

## SPECIFICATIONS

$V_{CC} = 5\text{ V}$ ,  $T = 25^\circ\text{C}$ , unless otherwise noted.

**Table 1.**

Parameter	Conditions	Min	Typ	Max	Unit
<b>OVERALL FUNCTION</b>					
Frequency Range		30		1000	MHz
Gain vs. Frequency	$\pm 50\text{ MHz}$ . Center Frequency = 190 MHz or 380 MHz		$\pm 0.25$		dB
Input Return Loss (S11)	50 MHz to 750 MHz		-10		dB
Output Return Loss (S22)	50 MHz to 750 MHz		-10		dB
<b>FREQUENCY = 70 MHz</b>					
Gain			19.8		dB
vs. Temperature	$-40^\circ\text{C} \leq T_A \leq +85^\circ\text{C}$		$\pm 0.25$		dB
Output 1 dB Compression Point			18.7		dBm
Output Third-Order Intercept	$\Delta f = 1\text{ MHz}$ , Output Power ( $P_{OUT}$ ) = 0 dBm (per tone)		37.3		dBm
Output Second Order Intercept	$\Delta f = 1\text{ MHz}$ , Output Power ( $P_{OUT}$ ) = 0 dBm (per tone)		TBD		dBm
Noise Figure			2.9		dB
<b>FREQUENCY = 380 MHz</b>					
Gain			18.6		dB
vs. Temperature	$-40^\circ\text{C} \leq T_A \leq +85^\circ\text{C}$		$\pm 0.25$		dB
Output 1 dB Compression Point			18.8		dBm
Output Third-Order Intercept	$\Delta f = 1\text{ MHz}$ , Output Power ( $P_{OUT}$ ) = 0 dBm (per tone)		35.7		dBm
Output Second Order Intercept	$\Delta f = 1\text{ MHz}$ , Output Power ( $P_{OUT}$ ) = 0 dBm (per tone)		TBD		dBm
Noise Figure			3.1		dB
<b>FREQUENCY = 820 MHz</b>					
Gain			16.8		dB
vs. Temperature	$-40^\circ\text{C} \leq T_A \leq +85^\circ\text{C}$		$\pm 0.25$		dB
Output 1 dB Compression Point			18.3		dBm
Output Third-Order Intercept	$\Delta f = 1\text{ MHz}$ , Output Power ( $P_{OUT}$ ) = 0 dBm (per tone)		34.5		dBm
Output Second Order Intercept	$\Delta f = 1\text{ MHz}$ , Output Power ( $P_{OUT}$ ) = 0 dBm (per tone)		TBD		dBm
Noise Figure			3.2		dB
<b>POWER INTERFACE</b>					
Supply Voltage	Pins RFOUT, $V_{CC}$	4.75	5	5.25	V
Supply Current			66		mA
vs. Temperature	$-40^\circ\text{C} \leq T_A \leq +85^\circ\text{C}$		75		mA
Power Dissipation	$V_{POS} = 5\text{ V}$		330		mW

## ABSOLUTE MAXIMUM RATINGS

Table 2.

Parameter	Rating
Supply Voltage, VPOS	5.5 V
Input Power (re: 75 $\Omega$ )	+12 dBm
Internal Power Dissipation (Paddle Soldered)	650 mW
$\theta_{JA}$ (Paddle Soldered)	TBD $^{\circ}\text{C}/\text{W}$
Maximum Junction Temperature	TBD $^{\circ}\text{C}$
Operating Temperature Range	$-40^{\circ}\text{C}$ to $+85^{\circ}\text{C}$
Storage Temperature Range (Soldering 60 sec)	$-65^{\circ}\text{C}$ to $+150^{\circ}\text{C}$ 240 $^{\circ}\text{C}$

Stresses above those listed under Absolute Maximum Ratings may cause permanent damage to the device. This is a stress rating only; functional operation of the device at these or any other conditions above those indicated in the operational section of this specification is not implied. Exposure to absolute maximum rating conditions for extended periods may affect device reliability.

### ESD CAUTION



**ESD (electrostatic discharge) sensitive device.** Charged devices and circuit boards can discharge without detection. Although this product features patented or proprietary protection circuitry, damage may occur on devices subjected to high energy ESD. Therefore, proper ESD precautions should be taken to avoid performance degradation or loss of functionality.

## PIN CONFIGURATION AND FUNCTION DESCRIPTIONS

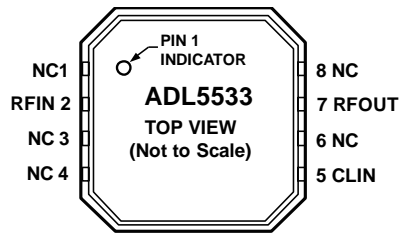

Figure 2. Pin Configuration

Table 3. Pin Function Descriptions Single

Pin No.	Mnemonic	Description
2	RFIN	RF Input: Requires a DC blocking capacitor.
7	RFOUT	RF Output and Bias: DC bias is provided to this pin through an inductor. RF path requires a DC blocking capacitor.
1, 3, 4, 6, 8	NC	No Connect
5	CLIN Exposed Paddle	A 10 nF capacitor connected between pin 5 and ground provides decoupling for the on board linearizer. Internally connected to GND. Solder to a low impedance ground plane

TYPICAL PERFORMANCE CHARACTERISTICS

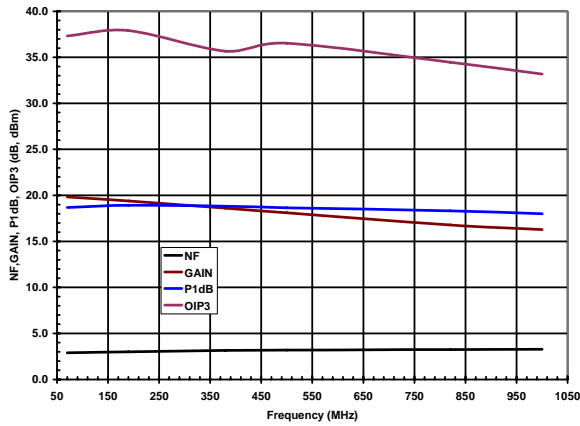

Figure 3 ADL5533 Gain, Noise Figure, OIP3 and P1dB vs Frequency

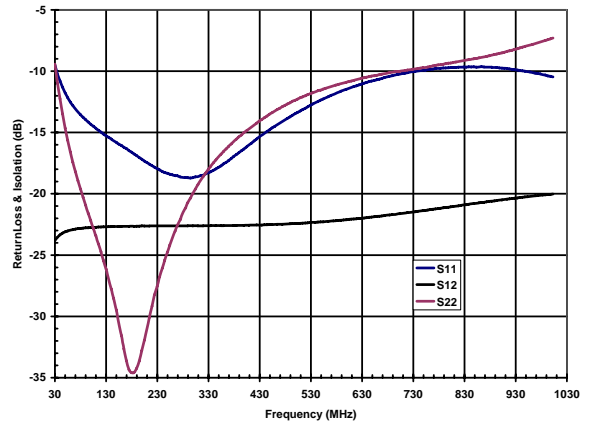

Figure 5 ADL5533 Input / Output Return Loss and Reverse Isolation vs Frequency

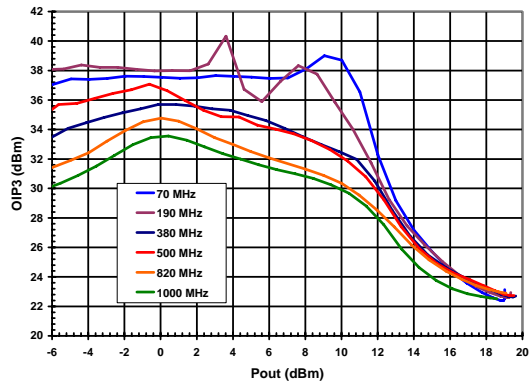

Figure 4 ADL5533 OIP3 vs Pout and Frequency

### EVALUATION BOARD

Figure 6 shows the schematic for the ADL, 5533 evaluation board. The board is powered by a single 5 V supply.

The components used on the board are listed in. Table 4 Power can be applied to the board through clip-on leads (Vcc, Gnd), or through Jumper W1.

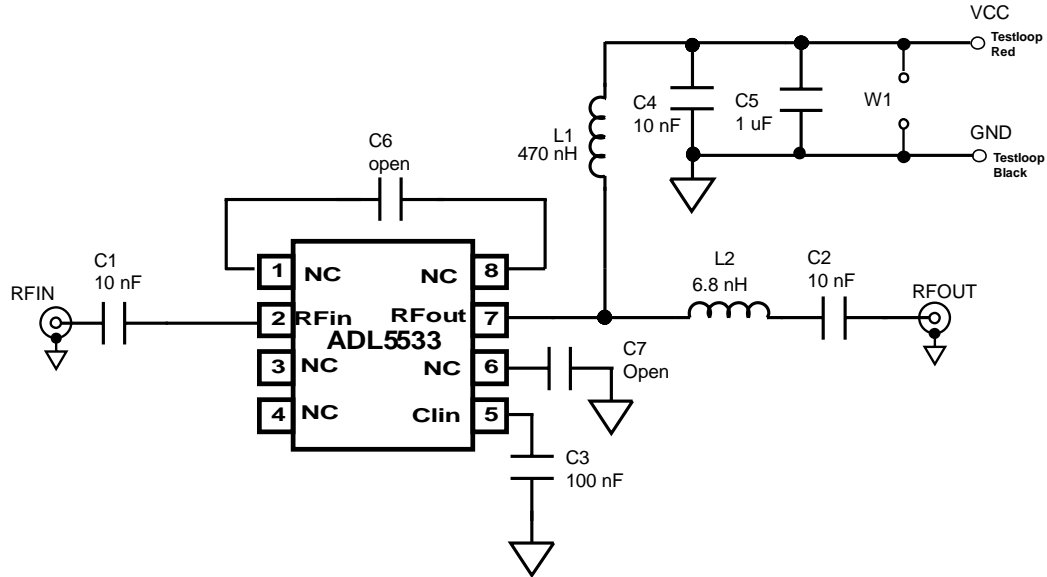

Figure 6. Evaluation Board Schematic

Table 4. Evaluation Board Configuration Options

Component	Function	Default Value
C1, C2	AC-coupling capacitors.	10 nF 0402
C3,	Compensates for internal non linearities	C3 100 nF 0603
C4, C5	Power Supply decoupling capacitors capacitor.	C4 10 nF 0603 C5 1uF 0603
C6, C7		Open 0603
L1	DC bias inductor.	470 nH L0603
L2	Output matching element.	6.8 nH L0603
VCC & GND	Clip-on terminals for power supply.	VCC Red GND Black
RFIN, RFOUT	RF input and output interface	75 ohm "F" type connectors
W1	2-pin jumper for connection of ground and supply via cable.	

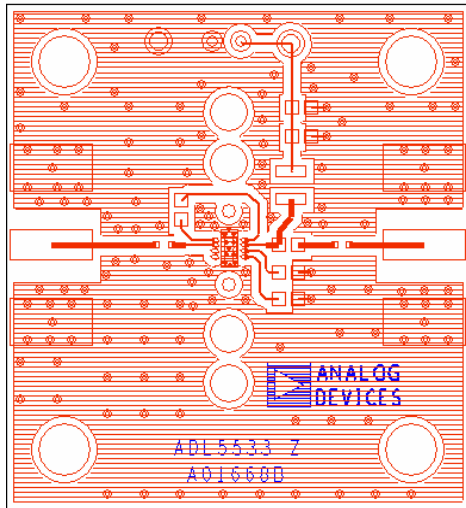

Figure 7. Evaluation Board Layout (Top)

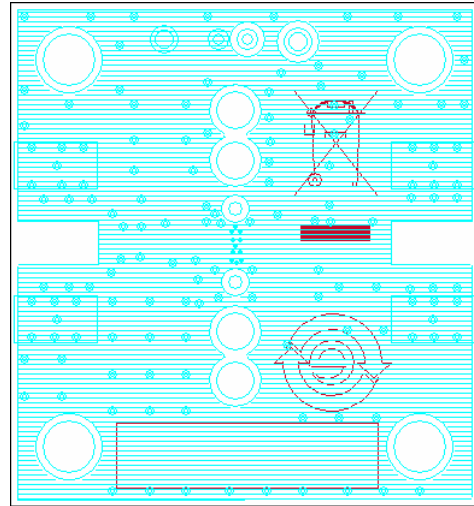

Figure 8. Evaluation Board Layout (Bottom)



OUTLINE DIMENSIONS

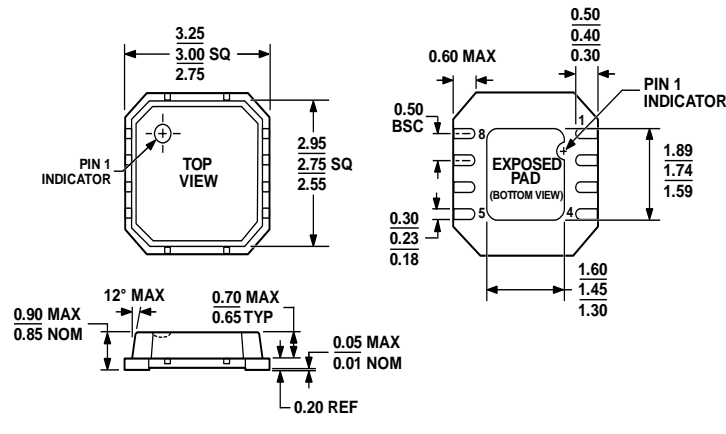

Figure 9. 8-Lead Lead Frame Chip Scale Package [LFCSP\_VD]  
 3mm x 3mm Body, Very Thin, Dual Lead  
 CP-8-2  
 Dimensions shown in millimeters

ORDERING GUIDE

Model	Temperature Range	Package Description	Package Option	Branding	Ordering Quantity
ADL5533ACPZ-R7 <sup>1</sup>	-40°C to +85°C	8-Lead LFCSP Tape and Reel	CP-8-2		
ADL5533ACPZ-WP <sup>1</sup>	-40°C to +85°C	8-Lead LFCSP Waffle Pack	CP-8-2		
ADL5533-EVALZ		Evaluation Board			

<sup>1</sup> Z = Pb-free part.